



# Medtronic

## LIFEPAK<sup>®</sup> 500

Automated External Defibrillator



## Operating Instructions





**OPERATING INSTRUCTIONS**

**LIFEPAK® 500**

Automated External Defibrillator

---

## IMPORTANT

**[!USA]** Federal (USA) law restricts this device to sale by or on the order of a physician. This automated external defibrillator (AED) is to be used by authorized personnel only.

### Device Tracking

**[!USA]** The U.S. Food and Drug Administration requires defibrillator manufacturers and distributors to track the location of their defibrillators. The address to which this particular device was shipped is now listed as the current tracking location. If the device is located somewhere other than the shipping address or the device has been sold, donated, lost, stolen, exported, or destroyed, or if the AED was not obtained directly from Medtronic, please either call the device tracking coordinator at 1.800.426.4448 or use one of the postage-paid address change cards located in the back of this manual to update this vital tracking information.

### Responsibility for Information

It is the responsibility of our customers to ensure that the appropriate person(s) within their organization have access to this information, including general safety information provided in Section 1.

### Revision History

These operating instructions describe LIFEPAK 500 devices with the monophasic defibrillation waveform (software version 5.5 or later) or the biphasic defibrillation waveform (software version 3.8 or later). Older devices may not have all the features described in this manual.



**Medtronic Emergency Response Systems**  
11811 Willows Road Northeast  
Redmond, WA 98052-2003 USA  
Telephone: 425.867.4000  
Toll Free (USA only): 800.442.1142  
Fax: 425.867.4121  
Internet: [www.medtronic-ers.com](http://www.medtronic-ers.com)  
[www.medtronic.com](http://www.medtronic.com)

**Medtronic Europe S.A.**  
Medtronic Emergency Response Systems  
Rte. du Molliau 31  
Case postale 84  
1131 Tolochenaz  
Switzerland  
Telephone: 41.21.802.7000  
Fax: 41.21.802.7900

---

LIFEPAK and FAST-PATCH are registered trademarks of Medtronic Emergency Response Systems, Inc. CODE SUMMARY, QUIK-COMBO, QUIK-VIEW, Data Transfer, REDI-PAK, Shock Advisory System, CODE-STAT, and PARTSLINE are trademarks of Medtronic Emergency Response Systems, Inc. Medtronic is a registered trademark of Medtronic, Inc. Zoom is a registered trademark and Hayes and ACCURA are trademarks of Zoom Technologies. U.S. Robotics and Sportster are registered trademarks of U.S. Robotics. Microsoft and Windows are registered trademarks of Microsoft Corporation. EPSON and EPSON ESC/P are registered trademarks of Seiko Epson Corporation. Specifications are subject to change without notice. ©1996-2005 Medtronic Emergency Response Systems, Inc. All rights reserved.

Publication Date 12/2005

MIN 3005338-010 / CAT. 26500-001009



To Purchase, Visit [Avobus.com](http://Avobus.com) or call [1-800-674-3655](tel:1-800-674-3655)

LIFEPAK 500 Automated External Defibrillator Operating Instructions

# TABLE OF CONTENTS

---

## Preface

About Defibrillation .....	X
Operator Considerations .....	X
Indications for Use .....	xi
LIFEPAK 500 Automated External Defibrillator .....	xi
Features of the LIFEPAK 500 Automated External Defibrillator .....	xi
Text Conventions .....	xiii

---

## 1 Safety Information

Terms .....	1-2
General Warnings and Cautions .....	1-2
Symbols .....	1-3

---

## 2 Getting Ready

Unpacking and Initial Inspection .....	2-2
Controls, Indicators, and Connectors .....	2-2
About Batteries .....	2-5
Setting the Clock .....	2-6
Defining Setup Options .....	2-7
Factory Default Settings .....	2-12

Transferring Setup to Another LIFEPAK 500 AED .....	2-13
Connecting Electrodes to the AED .....	2-14

---

### 3 Using the LIFEPAK 500 AED

Warnings and Cautions.....	3-2
Preparing the AED for Operation .....	3-2
AED Operation .....	3-3
AED Prompts.....	3-5
Patient Care Transfer to a Different Device.....	3-10
Troubleshooting During Patient Care.....	3-10

---

### 4 Data Management

Overview of Data Storage and Retrieval.....	4-2
Sending Data to a Computer by Modem.....	4-5
Sending Data to a Computer by Direct Connection.....	4-8
Sending Data to a Printer .....	4-9

---

### 5 Maintenance

Maintenance and Testing Scheduling.....	5-2
Inspection .....	5-2
Cleaning.....	5-4
Testing.....	5-4
Battery Maintenance .....	5-7
Electrode Storage .....	5-13
Service and Repair .....	5-13
Warranty.....	5-14
Supplies, Accessories, and Training Tools .....	5-14
Specifications.....	5-15
Clinical Summary: Defibrillation of Ventricular Fibrillation and Ventricular Tachycardia.....	5-21

---

### 6 Troubleshooting

Troubleshooting During Patient Care.....	6-2
------------------------------------------	-----

---

#### Appendix A: Shock Advisory System

#### Appendix B: LIFEPAK 500 Operator's Checklist

#### Appendix C: FAST-PATCH Defibrillation Cable Instructions for Use

#### Appendix D: QUIK-COMBO Defibrillation Cable Instructions for Use

#### Appendix E: Declarations of Conformity / Electromagnetic Compatibility Guidance

---

#### Index

## LIST OF FIGURES

Figure 2-1	LIFEPAK 500 AED controls, indicators, and connectors .....	2-2
Figure 2-2	Accessories for the LIFEPAK 500 AED .....	2-4
Figure 2-3	Battery installation.....	2-5
Figure 2-4	Setup transfer connections .....	2-13
Figure 2-5	Connecting the QUIK-COMBO electrodes .....	2-14
Figure 3-1	Anterior-lateral position.....	3-3
Figure 3-2	Anterior-posterior placement .....	3-4
Figure 4-1	Data stored by the LIFEPAK 500 AED .....	4-2
Figure 4-2	Comparison of data stored for the Current Patient and Previous Patient .....	4-3
Figure 4-3	Data stored when the AED stores a new patient record.....	4-3
Figure 4-4	Equipment connections for data transfer by modem .....	4-6
Figure 4-5	Equipment connections for data transfer by direct connection to a computer.....	4-8
Figure 4-6	Connecting the AED to a printer.....	4-10
Figure 4-7	Example of Event Log Report and Event Log Summary.....	4-12
Figure 4-8	Example of CODE SUMMARY Report .....	4-13
Figure 4-9	Example of CODE SUMMARY Report (cont.) .....	4-14
Figure 4-10	Example of CODE SUMMARY Report (cont.) .....	4-15
Figure 4-11	Test Log Report Example .....	4-16
Figure 5-1	Test load connection .....	5-6
Figure 5-2	Active life, no patient use .....	5-9
Figure 5-3	Active life, one patient use per year.....	5-9
Figure 5-4	Active life, patient use every two months.....	5-9

Figure 5-5	SLA battery capacity while installed in an AED for 3 months at 20°C (68°F) without recharging .....	5-11
Figure C-1	FAST-PATCH defibrillation cable for the LIFEPAK 500 AED .....	C-1
Figure C-2	Attaching lanyard .....	C-1
Figure C-3	Inserting defibrillation cable into AED .....	C-1
Figure C-4	Connecting to FAST-PATCH defibrillation/ECG electrodes .....	C-1
Figure C-5	Disconnecting from electrodes .....	C-2
Figure D-1	QUIK-COMBO defibrillation cable for the LIFEPAK 500 AED .....	D-1
Figure D-2	Attaching lanyard .....	D-1
Figure D-3	Inserting defibrillation cable into AED .....	D-1
Figure D-4	Connecting QUIK-COMBO electrodes .....	D-2



## LIST OF TABLES

Table 2-1	Controls, Indicators, and Connectors.....	2-2
Table 2-2	Accessories for the LIFEPAK 500 AED.....	2-4
Table 2-3	Modem Phone Number Dial String Characters.....	2-7
Table 2-4	Modem Selection Numbers.....	2-8
Table 2-5	Setup Options and Factory Default Settings.....	2-12
Table 4-1	LIFEPAK 500 AED Data and Retrieval.....	4-4
Table 4-2	Required Resources for Sending Data to a Computer by Modem.....	4-5
Table 4-3	Required Resources for Sending Data to a Computer by Direct Connection.....	4-8
Table 4-4	Required Resources for Printing Data.....	4-9
Table 5-1	LIFEPAK 500 AED Inspection.....	5-2
Table 5-2	Recommended Cleaning Methods.....	5-4
Table 5-3	Supplies, Accessories, and Training Tools.....	5-14
Table 5-4	LIFEPAK 500 AED Specifications.....	5-15
Table 5-5	LIFEPAK 500 AED Battery Charger Specifications.....	5-20
Table 6-1	Troubleshooting During Patient Care.....	6-2
Table 6-2	Troubleshooting During Modem Data Transfer.....	6-3
Table 6-3	Troubleshooting During Printing.....	6-4
Table 6-4	Troubleshooting During Setup Transfer.....	6-5
Table 6-5	LIFEPAK 500 AED Screen Messages.....	6-6
Table 6-6	LIFEPAK 500 AED Voice Prompts.....	6-8
Table 6-7	LIFEPAK 500 AED Event Types.....	6-9
Table A-1	LIFEPAK 500 AED SAS Performance Table for Adult ECGs.....	A-1
Table A-2	LIFEPAK 500 AED SAS Performance Table for Pediatric ECGs.....	A-2

Table E-1	Guidance and Manufacturer’s Declaration - Electromagnetic Emissions .....	E-3
Table E-2	Guidance and Manufacturer’s Declaration - Electromagnetic Immunity.....	E-4
Table E-3	Guidance and Manufacturer’s Declaration - Electromagnetic Immunity.....	E-5
Table E-4	Recommended Separation Distances .....	E-6



To Purchase, Visit [Avobus.com](http://Avobus.com) or call [1-800-674-3655](tel:1-800-674-3655)

## PREFACE

About Defibrillation	page x
Operator Considerations	x
Indications for Use	xi
LIFEPAK 500 Automated External Defibrillator	xi
Features of the LIFEPAK 500 Automated External Defibrillator	xi
Text Conventions	xiii

---

## ABOUT DEFIBRILLATION

Defibrillation is a recognized means of terminating certain potentially fatal arrhythmias. A direct current defibrillator applies a brief, high-energy pulse of electricity to the heart muscle. The LIFEPAK® 500 Automated External Defibrillator (AED) delivers this energy through disposable defibrillation electrodes applied to the patient's chest.

Defibrillation is only one aspect of the medical care required to resuscitate a patient with a shockable ECG rhythm. Depending on the situation, other supportive measures may include:

- Cardiopulmonary resuscitation (CPR)
- Administration of supplemental oxygen
- Drug therapy

It is recognized that successful resuscitation is related to the length of time between the onset of a heart rhythm that does not circulate blood (ventricular fibrillation, pulseless ventricular tachycardia) and defibrillation. The American Heart Association has identified the following as critical links in the chain of survival from cardiac arrest:

- Early access
- Early CPR by first responders or bystanders
- Early defibrillation
- Early advanced life support

The physiological state of the patient may affect the likelihood of successful defibrillation. Thus, failure to resuscitate a patient is not a reliable indicator of defibrillator performance. Often, patients will exhibit a muscular response (such as jumping or twitching) during energy transfer. The absence of such a response is not a reliable indicator of actual energy delivery or device performance.

---

## OPERATOR CONSIDERATIONS

The LIFEPAK 500 AED is a semi-automatic defibrillator that uses a patented Shock Advisory System™. This software algorithm analyzes the patient's electrocardiographic (ECG) rhythm and indicates whether or not it detects a shockable rhythm. The LIFEPAK 500 AED requires operator interaction to defibrillate the patient.

The LIFEPAK 500 AED is intended for use by personnel who are authorized by a physician/medical director and have, at a minimum, the following skills and training:

- CPR training
- AED training equivalent to that recommended by the American Heart Association
- Training in the use of the LIFEPAK 500 AED

The LIFEPAK 500 AED is intended for use in the hospital and out-of-hospital environments. It has been tested to RTCA/DO-160C, "Environmental Conditions and Test Procedures for Airborne Equipment" (refer to Specifications, page 5-15).

---

## INDICATIONS FOR USE

The LIFEPAK 500 AED is to be used only on patients in cardiopulmonary arrest. The patient must be unconscious, not breathing normally, and showing no signs of circulation (for example, no pulse, and/or no coughing, no movement) before the device is used to analyze the patient's ECG rhythm. With Infant/Child Reduced Energy Defibrillation Electrodes, the specially configured biphasic LIFEPAK 500 AED may be used on children who are less than eight years old or who weigh less than 25 kg (55 lb).

---

## LIFEPAK 500 AUTOMATED EXTERNAL DEFIBRILLATOR

### LIFEPAK 500 AED, Monophasic

Yellow exterior with monophasic waveform.

### LIFEPAK 500 AED, Biphasic

Yellow exterior with biphasic waveform.

### LIFEPAK 500 AED, Public Safety

Dark Gray exterior with biphasic waveform.

---

## FEATURES OF THE LIFEPAK 500 AUTOMATED EXTERNAL DEFIBRILLATOR

The optional and configurable features of the LIFEPAK 500 AED are designed to meet a variety of protocol needs. Authorized operators of this AED should always use the AED in accordance with local protocols.

### Defibrillation Waveform

The LIFEPAK 500 AED is available with one of two defibrillation waveforms: monophasic or biphasic. For a description of each defibrillation waveform, refer to page 5-16 and page 5-20. The LIFEPAK 500 AED control and display functions are the same for either defibrillation waveform.

### Defibrillation Electrodes

The LIFEPAK 500 AED uses disposable QUIK-COMBO™ pacing/defibrillation/ECG electrodes, with or without the REDI-PAK™ preconnect system, and FAST-PATCH® disposable defibrillation/ECG electrodes. The use of these electrodes allows rapid transfer of care to other devices that also use the same type of Medtronic electrodes.

Infant/Child Reduced Energy Defibrillation Electrodes can be used only with a biphasic LIFEPAK 500 AED that has been modified specifically to accept these electrodes. (Refer to Item 4, Cable Connector on page 2-3.) Infant/Child Reduced Energy Defibrillation Electrodes are not transferable to manual defibrillator/monitors and are not compatible with the QUIK-COMBO Therapy Cable (refer to Appendix D).

## Automated Operation

The operator controls AED operation with two or three top-panel buttons (**ON/OFF**, **ANALYZE** [optional], and **SHOCK**). For LIFEPAK 500 AEDs that do not have an **ANALYZE** button, the AED operates in **AUTO ANALYZE 2** mode (refer to page 2-9).

The AED guides the operator through operating procedures with a combination of:

- Voice prompts
- Tones
- Flashing LEDs
- Screen messages

The screen messages appear on a two-line liquid crystal display (LCD). Other LCD information includes:

- Real-time clock
- Cumulative shock counter
- Status and service messages
- CPR countdown timer

## Continuous Monitoring

The LIFEPAK 500 AED operates in two modes: ECG analysis and Continuous Patient Surveillance System (CPSS). During analysis, the AED indicates if it detects a shockable or nonshockable rhythm. The CPSS, which is active when the AED is not performing an analysis, automatically monitors for a potentially shockable rhythm.

## Motion Detection

The LIFEPAK 500 AED includes a patented system that detects motion. When motion that could distort the ECG rhythm occurs, the ECG data is automatically excluded from analysis by the motion detection system.

## Data Management

The LIFEPAK 500 AED digitally records patient data, including ECG rhythm and delivered shocks. A digital audio recording of scene activity is available as an option. Recorded data may be transferred by direct connection to a printer or computer or by a modem to a remote computer. Three optional, Microsoft® Windows®-compatible data management software programs are available. The Data Transfer™ 500 program transfers, stores, and prints AED reports. The QUIK-VIEW™ 500 data review program includes all of the Data Transfer 500 functions and the capability to review ECG and audio data on a computer. The CODE-STAT™ Suite data management system provides comprehensive and varied data storage, review, and reporting capabilities for quality assessment and system performance analysis.

## Battery Options

A rechargeable sealed lead-acid battery or one of two nonrechargeable lithium batteries (sulfur dioxide or manganese dioxide) provide power to the AED. The rechargeable battery requires periodic recharging by an external battery charger.

## Automatic Self-Test

The AED performs an automatic self-test every 24 hours and every time you turn on the AED. This feature tests the most important circuitry in the device to give the user a high degree of confidence that the AED is ready for use.

## Readiness Display

Most LIFEPAK 500 AEDs with the biphasic waveform include a readiness display on the device's handle that can be seen at all times. **OK** displays if the automatic self-test is completed successfully. If the self-test detects that service is required or if the device detects that the battery needs immediate replacement, the **OK** indicator disappears and a service and/or battery indicator appear(s).

## Customized Setup

Operation may be customized for a LIFEPAK 500 AED with a readiness display by accessing a setup mode. Definable operating features include the modem phone number, the time interval allowed for CPR, and other features. Refer to the *LIFEPAK 500 Automated External Defibrillator Setup Instructions* (MIN 3012275) for more information about customized setup options.

Once you have customized the setup, the **TRANSFER SETUP** feature enables you to quickly transfer the setup to other LIFEPAK 500 AEDs.

## Optional Accessories

Optional soft and hard carrying cases help to protect the AED and provide a pouch to store electrodes. Use the Medtronic LIFEPAK 500 AED Trainer to train operators to use the LIFEPAK 500 AED.

---

## TEXT CONVENTIONS

Throughout this manual, special text characters are used to indicate labels, LCD messages, and voice prompts:

Operating control labels:	<b>CAPITAL LETTERS</b> such as <b>ON/OFF</b> and <b>SHOCK</b> .
LCD messages:	<b>CAPITAL LETTERS</b> such as <b>CONNECT ELECTRODES</b> .
Voice prompts:	<b>CAPITAL ITALICIZED LETTERS</b> such as <b><i>PUSH ANALYZE</i></b> .



To Purchase, Visit [Avobus.com](http://Avobus.com) or call [1-800-674-3655](tel:1-800-674-3655)



## SAFETY INFORMATION

This section provides important information to help you operate the LIFEPAK 500 Automated External Defibrillator (AED). Familiarize yourself with all of these terms, warnings, and symbols.

Terms	page 1-2
General Warnings and Cautions	1-2
Symbols	1-3

---

## **TERMS**

The following terms are used either in this manual or on the LIFEPAK 500 AED:

**Danger:** Immediate hazards that will result in serious personal injury or death.

**Warning:** Hazards or unsafe practices that could result in serious personal injury or death.

**Caution:** Hazards or unsafe practices that could result in minor personal injury, product damage, or property damage.

---

## **GENERAL WARNINGS AND CAUTIONS**

The following section provides general warning and caution statements. Other specific warnings and cautions are provided as needed in other sections of this manual.

### **WARNINGS!**

#### **Shock hazard.**

The defibrillator delivers up to 360 joules of electrical energy. Unless properly used as described in these Operating Instructions, this electrical energy may cause serious injury or death. Do not attempt to operate this device unless thoroughly familiar with these Operating Instructions, and the function of all controls, indicators, connections, and accessories.

#### **Shock hazard.**

Do not disassemble the defibrillator. It contains no operator serviceable components and dangerous high voltages may be present. Contact authorized service personnel for repair.

#### **Shock or fire hazard.**

Do not immerse any portion of this device in water or other fluids. Avoid spilling any fluids on device or accessories. Do not clean with ketones or other flammable agents. Do not autoclave or sterilize this device or accessories unless otherwise specified.

#### **Possible fire or explosion.**

Do not use this device in the presence of flammable gases or anesthetics. Use care when operating this device close to oxygen sources (such as bag-valve-mask devices or ventilator tubing). Turn off gas source or move source away from patient during defibrillation.

#### **Possible electrical interference with device performance.**

Equipment operating in close proximity may emit strong electromagnetic or radio frequency interference (RFI) which could affect the performance of this device. RFI may result in improper device operation, distorted ECG, failure to detect a shockable rhythm, or cessation of pacing. Avoid operating the device near cauterizers, diathermy equipment, cellular phones, or other portable and mobile RF communications equipment. Maintain equipment separation of at least 1.2 m (4 ft) and do not rapidly key EMS radios on and off. Contact a technical support representative if assistance is required.

#### **Possible electrical interference.**

Using cables, electrodes, or accessories not specified for use with this device may result in increased emissions or decreased resistance to electromagnetic interference which could affect the performance of this device or of equipment in close proximity. Use only parts and accessories specified in these operating instructions.

**WARNINGS!**

**Possible electrical interference.**

This defibrillator may cause electromagnetic interference (EMI) especially during charge and energy transfers. EMI may affect the performance of equipment operating in close proximity. Verify the effects of defibrillator discharge on other equipment prior to using defibrillator in an emergency situation, if possible.

**Possible device shutdown.**

Always have access to a spare, fully-charged, properly maintained battery. Replace the battery when the device displays a low battery warning.

**Possible improper device performance.**

Using other manufacturers' cables, electrodes, or batteries may cause the device to perform improperly and invalidates the safety agency certification. Use only the accessories specified in these Operating Instructions.

**Safety risk and possible equipment damage.**

Monitors, defibrillators, and their accessories (including electrodes and cables) contain ferromagnetic materials. As with all ferromagnetic equipment, these products must not be used in the presence of the high magnetic field created by a Magnetic Resonance Imaging (MRI) device. The high magnetic field created by an MRI device will attract the equipment with a force sufficient to cause death or serious personal injury to persons between the equipment and the MRI device. This magnetic attraction may also damage the equipment. Skin burns will also occur due to heating of electrically conductive materials, such as patient leads and pulse oximeter sensors. Consult the MRI manufacturer for more information.

**Shock hazard.**

Do not insert a hand, foot, or any object other than a battery into the battery well of this device.

**CAUTION!**

**Possible equipment damage.**

This device may be damaged by mechanical or physical abuse such as immersion in water or dropping the device. If the device has been abused, remove it from use and contact a qualified service technician.

**SYMBOLS**

The symbols below may be found in this manual or on various configurations of the LIFEPAK 500 AED and accessories:



Defibrillation protected, type BF patient connection



















Attention, consult accompanying documents



Warning, high voltage

## Safety Information

-  Indicator, steady display indicates battery is low, replace battery; flashing (key panel only) indicates replace battery immediately
-  Indicator, steady display indicates device requires service; flashing (key panel only) indicates service is required immediately
- OK** Indicator, appears on the readiness display indicating the self-test completed successfully
-  Buttons for setting the clock, transferring data, and setting options
-  Type BF patient connection
-  Rechargeable battery: recycle battery
-  Do not dispose of this product in the unsorted municipal waste stream. Dispose of this product according to local regulations. See <http://recycling.medtronic.com> for instructions on disposing of this product.
-  Battery Charger: green LED indicates power is on
-  Battery Charger: battery is charging; amber LED indicates fast charge, green LED indicates trickle charge
-  Indoor use only
-  Safety Class II equipment (reinforced insulation)
-  Data Cable: to printer
-  Data Cable: to PC
-  Data Cable: to modem
-  Setup transfer cable
- LOT yyww** Lot number (batch code)
-  Use By date shown: yyyy-mm-dd or yyyy-mm
-  Single use only



Mark of conformity according to the European Medical Device Directive 93/42/EEC



Canadian Standards Association certification for Canada and the United States



Cable Connector



Biphasic defibrillation shock



The Infant/Child Reduced Energy Defibrillation Electrodes are not compatible with QUIK-COMBO defibrillation and therapy cables. To use Infant/Child electrodes, connect Infant/Child electrodes directly to the AED.



For USA audiences only

REF

Reorder number (same as CAT.)

MIN

Manufacturer's item number

CAT.

Catalog number used for placing orders



To Purchase, Visit [Avobus.com](http://Avobus.com) or call [1-800-674-3655](tel:1-800-674-3655)

## GETTING READY

This section provides a basic orientation to the LIFEPAK 500 Automated External Defibrillator (AED) and describes how to prepare the AED for use.

Unpacking and Initial Inspection	page 2-2
Controls, Indicators, and Connectors	2-2
About Batteries	2-5
Setting the Clock	2-6
Defining Setup Options	2-7
Factory Default Settings	2-12
Transferring Setup to Another LIFEPAK 500 AED	2-13
Connecting Electrodes to the AED	2-14

## UNPACKING AND INITIAL INSPECTION

Remove the LIFEPAK 500 AED from the shipping container. Examine the AED and accessories for any sign of damage during shipping. Make sure that all the required supplies and accessories, including electrodes and batteries, are present. Save the shipping container and foam inserts for use in reshipping the AED.

## CONTROLS, INDICATORS, AND CONNECTORS

Figure 2-1 and Table 2-1 provide an overview of the LIFEPAK 500 AED controls, indicators, and connectors. Figure 2-2 and Table 2-2 provide an overview of the accessories.

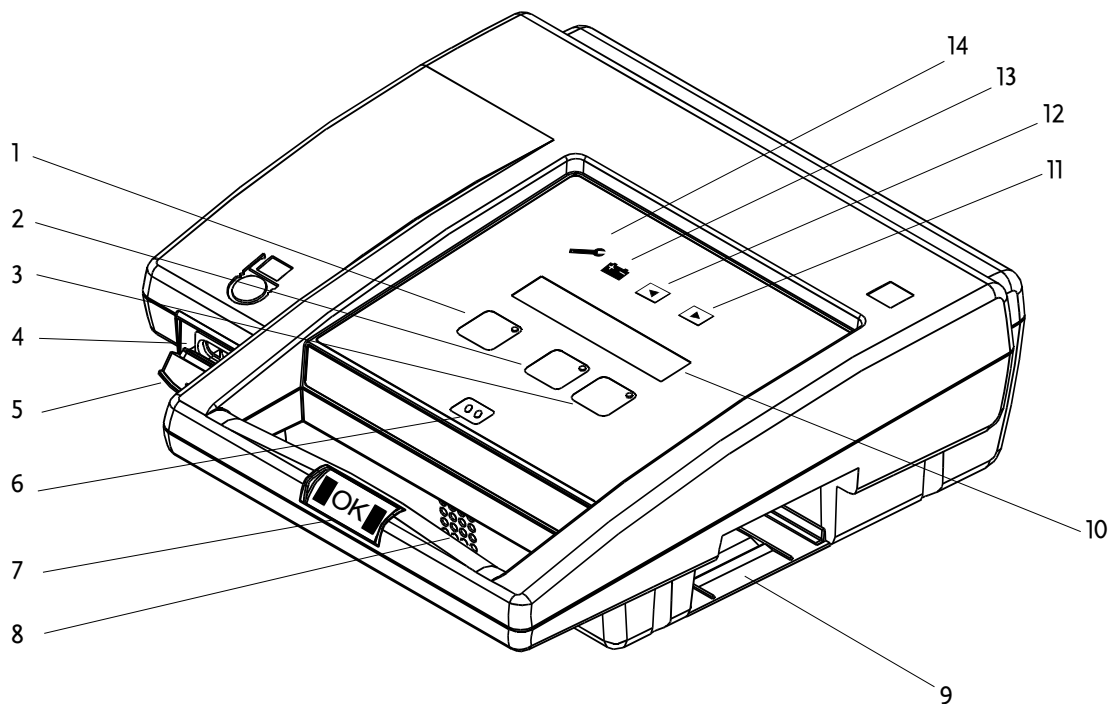









Figure 2-1 LIFEPAK 500 AED controls, indicators, and connectors

Table 2-1 Controls, Indicators, and Connectors

1		Green <b>ON/OFF</b> button turns the power on or off. The LED is lit whenever the AED is on.
2		<p>Yellow <b>ANALYZE</b> button initiates analysis of the patient's ECG rhythm when pressed. The LED is lit while the AED analyzes the rhythm. The LED flashes to prompt the operator to press <b>ANALYZE</b>.</p> <p><b>Note:</b> Does not apply to LIFEPAK 500 AEDs that do not have an <b>ANALYZE</b> button. In this case, the <b>ANALYZE</b> button is replaced by a blank <b>MENU</b> button, and analysis occurs automatically.</p>



3		Orange <b>SHOCK</b> button delivers energy. The LED flashes to prompt the operator to press <b>SHOCK</b> when the AED is fully charged.
4	Cable Connector Receptacle	Allows connection to the following: <ul style="list-style-type: none"> <li>• QUIK-COMBO electrodes (REDI-PAK or LLW)</li> <li>• Cables for connection to a printer, computer, modem, another LIFEPAK 500 AED, or FAST-PATCH electrodes</li> <li>• Test load for testing</li> <li>• Patient Simulator</li> </ul> If the cable connector has a pink-colored center, Infant/Child Reduced Energy Defibrillation Electrodes can be used with the AED by connecting the electrodes directly to the cable connector receptacle.
5	Connector Cover	Protects cable connector.
6	Microphone	Allows input for audio recording.
7	Readiness Display	Displays <b>OK</b> when the automatic self-test is completed successfully. If the self-test detects that service is required or if the device detects that the battery needs immediate replacement, the <b>OK</b> indicator disappears and a service and/or battery indicator appear(s).
8	Speaker	Provides audio voice prompts and tones.
9	Battery Compartment	Accommodates a single removable battery pak that provides power for the AED.
10	Liquid Crystal Display (LCD)	Provides operating messages on two 20-character lines.*
11	 Right arrow button	Used to set the clock, transfer data, and set options.
12	 Up arrow button	Used to set the clock, transfer data, and set options.
13	 Low battery indicator	Steady display indicates the AED battery is low; flashing, on keypad only, indicates replace battery immediately.
14	 Service indicator	Steady display indicates the AED requires service by authorized service personnel; flashing indicates service is required immediately.

\* Accent marks are not included in operating messages for international languages.

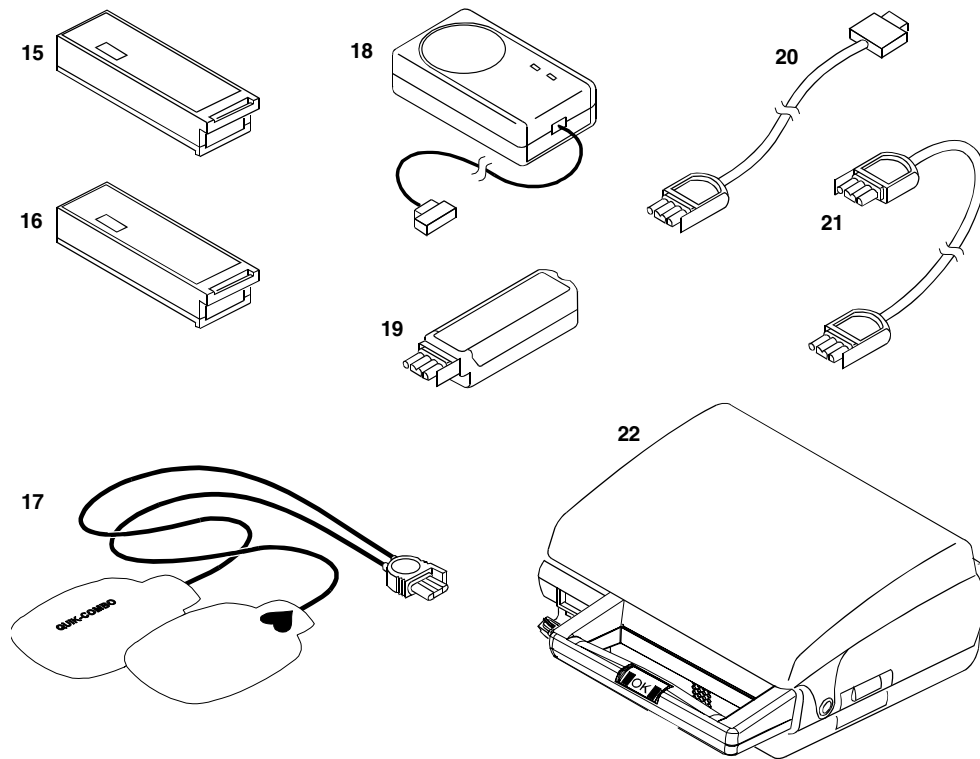

Figure 2-2 Accessories for the LIFEPAK 500 AED

Table 2-2 Accessories for the LIFEPAK 500 AED

15	LIFEPAK 500 nonrechargeable lithium battery pak	Provides power for the LIFEPAK 500 AED.
16	LIFEPAK 500 rechargeable SLA battery pak	Provides power for the LIFEPAK 500 AED. The SLA (Sealed Lead-Acid) battery pak is recharged by the battery charger listed in 18.
17	QUIK-COMBO electrodes	Allow delivery of therapy to the patient. Connect to the cable connector on the AED or to the QUIK-COMBO defibrillation cable (see Appendix D).
18	Battery Charger	Provides power to recharge the rechargeable SLA battery pak.
19	Test Load	Provides an external test load for the AED. Connects to the cable connector on the AED.
20	Data cable	One of three available cables shown. Allows transfer of data from AED to PC, modem, or printer. Plugs into the cable connector on the AED. Cables are 3-wire cables.
21	Setup Transfer Cable	Allows transfer of customized device setup from one LIFEPAK 500 AED to another.
22	Carrying cases	Hard and soft carrying cases available. Cases help protect the AED and provide storage for electrodes.

## ABOUT BATTERIES

Use either of the following battery types to power the LIFEPAK 500 AED:

- LIFEPAK 500 rechargeable sealed lead-acid (SLA) battery pak
- LIFEPAK 500 nonrechargeable lithium sulfur dioxide (LiSO<sub>2</sub>) battery pak
- LIFEPAK 500 nonrechargeable lithium manganese dioxide (LiMnO<sub>2</sub>) battery pak

To save battery life if the LIFEPAK 500 AED is accidentally turned on or left on, the AED has a battery conservation feature. If the AED is not connected to a patient and no buttons are pressed for 15 minutes, the AED will automatically turn off.

With a battery installed, the LIFEPAK 500 AED automatically performs daily auto tests when the AED is not in use. These auto tests, along with normal battery self-discharge, consume battery energy.

For information about maintaining or recharging the batteries, refer to page 5-7.

## Battery Installation

### WARNING!

Inability to provide therapy.

The LIFEPAK 500 nonrechargeable lithium manganese dioxide battery pak **does not fit** in all LIFEPAK 500 AEDs. Use only with AEDs marked -003 inside the battery well.

To install a battery:

- 1 Insert the connector end of the battery into the battery compartment as shown in Figure 2-3.
- 2 Slide the battery all the way in until it latches securely.

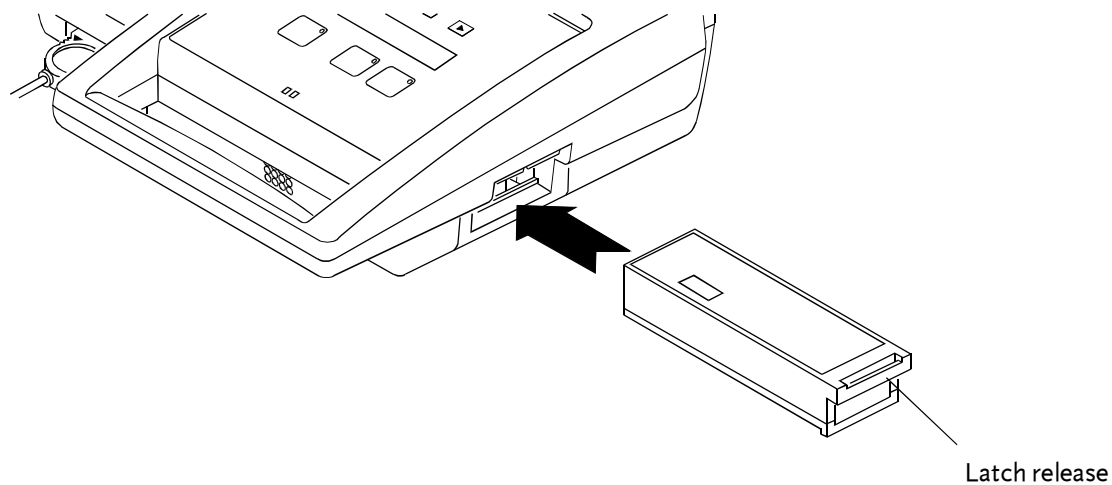

Figure 2-3 Battery installation

## Battery Removal

To remove the battery:

- 1 Turn off the AED.
- 2 Lift the latch release on the battery and slide it out.

**Note:** When a battery is removed from the AED, battery and service indicators appear on the readiness display. After replacing the battery, turn on the device to reset the readiness display.

## Low Battery Detection

Whenever the LIFEPAK 500 AED is turned on after it has been off for at least 60 seconds, it takes about 10 seconds to complete a self-test and to indicate a low or replace battery condition.

The AED monitors the battery power level and indicates when the battery should be replaced:



Indicator illuminates on the device key panel and appears on the readiness display and the **LOW BATTERY** message displays on the LCD; battery is low.

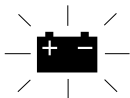

Indicator flashes on and off on the device key panel, the **REPLACE BATTERY** message displays, and a voice prompt sounds; battery is low and should be replaced immediately.

**Note:** The readiness display battery indicator does not flash.

When the battery power is too low, the AED will automatically turn off. The service and battery indicators appear on the readiness display.

If the **AUDIO ALERT** option is set to **ON** and the AED detects a low or replace battery condition during an automatic self-test while it is not in use, audible beeps and the **REPLACE BATTERY** voice prompt sounds. The **AUDIO ALERT** will repeat every 20 minutes until the battery is replaced or battery power becomes too low to power the AED.

---

## SETTING THE CLOCK

You may set the clock at any time except during the interval between patient care and data transfer to a computer or printer. Setting the clock during this interval will interfere with proper time synchronization.

To change the date and time:

- 1 Turn on the AED. (Be sure the AED has been off for at least 60 seconds and that nothing is connected to the AED.)
- 2 Press and hold the ▲ or ► button for approximately three seconds until the AED displays the date and time setting:



Blinking

A value blinking on and off indicates that the value can be changed. The day, month, year, hour, and minutes values can be increased. The seconds value can be reset to zero.

- 3 To set the hour:
  - Press the ▲ button to increase the value.
  - Press the ► button to advance to the next field.
- 4 To set the minutes:
  - Press the ▲ button to increase the value.
  - Press the ► button to advance to the next field.
- 5 To reset the seconds value to zero:
  - Press the ▲ button once.

**Note:** If the seconds value is less than 30 when reset, the minutes value stays the same. If the seconds value is greater than 30 seconds when reset, the minutes value increases by one.

  - Press the ► button to advance to the next field.
- 6 Repeat Step 3 as needed to set the day, month, and year.
- 7 After the date and time are set, press **ON/OFF** to turn off the AED.

## DEFINING SETUP OPTIONS

The following paragraphs describe the setup options that define some of the operating features for the LIFEPAK 500 AED. The user should become thoroughly familiar with the operating features particular to their LIFEPAK 500 AED.

### Device ID

The **DEVICE ID** option assigns a unique identifier that is printed at the top of each report. Up to 20 characters with any combination of displayable characters can be used. The factory default setting is an automatically generated sequence number.

### Modem Phone Number

The **MODEM PHONE NUMBER** option is the character string that the AED dials when it transfers data by modem. The dial string may include up to 20 characters as described in Table 2-3. The factory default dial string is T9W1886279698. This is the dial string required to download data from the LIFEPAK 500 AED to LIFELINK MD under the LIFENET MD medical control plan. The characters T9W are required if 9 must be dialed first to access an outside line from the telephone being used. However, if the telephone being used has direct access (long distance dialing begins with 1), change T9W to blanks.

Table 2-3 Modem Phone Number Dial String Characters

Character	Description
P	Selects pulse dialing (only allowed as first character)
T	Selects tone dialing (only allowed as first character)
,	Inserts 2-second pause in dialing string
\$	Waits for "bong" (calling card) tone
W	Waits for second dial tone
Alphanumeric characters	A, B, C, D and 0 through 9 (no special function)
* # ( )	Other characters (no special function)
+	Terminates dial string

## Modem Selection

The **MODEM SELECTION** option determines the initialization string for the modems listed in Table 2-4. Select the number that matches your modem. If you select 0, you must define the modem initialization string in the next option (**MODEM INIT STRING**). The factory default is 5.

Table 2-4 Modem Selection Numbers

Number	Modem Type
0	No modem selected*
1	Hayes™ ACCURA 288 External Fax Modem Hayes ACCURA 336 External Fax Modem
2	U. S. Robotics® Sportster® 28.8 Modem U. S. Robotics Sportster 33.6 Modem
3	Motorola Lifestyle 28.8 Data/Fax Modem
4	SupraExpress 33.6 Fax Modem Hayes ACCURA 144 External Fax Modem Hayes ACCURA 56K External Fax Modem Hayes ACCURA 336 External Fax Modem with Voice Hayes ACCURA 336 External Fax Modem with Simultaneous Voice and Data Hayes ACCURA 56K Speakerphone Modem
5	U. S. Robotics Courier V.Everything U. S. Robotics 56K Fax Modem (Sportster)

\* You must specify the modem initialization string in the **MODEM INIT STRING** option.

**Note:** The selection of commercially available modems changes rapidly. For more information or assistance regarding compatible modems, contact Medtronic Technical Support. In the USA call 1.800.442.1142. Outside the USA, contact your local Medtronic representative.

## Modem Initialization String

The **MODEM INIT STRING** option defines the modem initialization string for a Hayes compatible modem (TIA/EIA-602). Up to 75 characters with any combination of displayable characters can be used. The factory default string is blank.

**Note:** The AED does not display **MODEM INIT STRING** unless the **MODEM SELECTION** is 0.

## Energy Sequence

The **ENERGY SEQUENCE** option defines the three possible energy levels used by the LIFEPAK 500 AED.

For the LIFEPAK 500 AED with the monophasic defibrillation waveform, energy level 1 is fixed at 200 joules, energy level 2 has a choice of 200 joules or 300 joules, and energy level 3 is fixed at 360 joules. The factory default setting for the second energy level is 300 joules.

For the LIFEPAK 500 AED with the biphasic defibrillation waveform, energy level 1 is fixed at 200 joules; however, choices are available for energy levels 2 and 3. The choices include:

- Energy level 1 (200 joules)
- Energy level 2 (200, 225, 250, 275, 300 joules)
- Energy level 3 (200, 225, 250, 275, 300, 325, 360 joules)

The factory default setting is energy level 1 (200 joules), energy level 2 (300 joules), and energy level 3 (360 joules).

## Energy Protocol

The **ENERGY PROTOCOL** option determines either a fixed or flexible sequence for your energy protocol. The factory default is flexible sequence.

Flexible sequence means the energy delivered for a shock increments only if an analysis immediately following a shock results in a **SHOCK ADVISED** decision. For example, if the AED energy sequence is set up as 200, 300, 360, flexible sequence means that the energy delivered for the first shock is 200 joules. If the arrhythmia is terminated by shock 1 and the next analysis results in a **NO SHOCK ADVISED** decision, the energy will **not** increase for the next shock. However, if the arrhythmia is not terminated by shock 1 and the next analysis results in a **SHOCK ADVISED** decision, the energy will increase to 300 joules.

Fixed sequence means that the energy delivered after the first shock of 200 joules increments from 200 to 300, and then to 360 joules, regardless of the post-shock ECG rhythm and subsequent analysis decision.

## Display Energy

The **DISPLAY ENERGY** option determines whether or not the energy of the last shock is displayed during use. The factory default setting is **ON**.

## Auto Analyze

The **AUTO ANALYZE** options are **OFF**, **1**, or **2**.

**AUTO ANALYZE OFF:** The operator must press **ANALYZE** to start every analysis.

**AUTO ANALYZE 1:** The second and third rhythm analyses of each three-shock set start automatically without requiring the operator to press **ANALYZE**. (The operator must always press **ANALYZE** to start the first analysis of a three-shock set and to analyze after a **NO SHOCK ADVISED** message or CPR cycle.) The factory default setting is **AUTO ANALYZE 1**.

**AUTO ANALYZE 2:** **ALL** analysis cycles are initiated automatically. LIFEPAK 500 AEDs that do not have an **ANALYZE** button operate in this mode.

## CPR Time

The **CPR TIME 1 AND 2** options define a time period during which you are prompted to perform CPR. The choices are: 0, 15, 30, 45, 60, 90, 120, and 180 seconds and 999 (infinite CPR Time). For all selections except 0 and 999, the AED prompts you to perform CPR and then displays a countdown timer. If CPR Time 999 is selected, the AED prompts you to perform CPR, but does not display the countdown timer. The AED will not prompt you to **PUSH ANALYZE**, although you may do so at any time to initiate an analysis.

CPR Time 1 defines the CPR period following each 3-shock set. CPR Time 2 defines the CPR period following a **NO SHOCK ADVISED** message. Check your local protocol for the appropriate CPR Time.

The **CPR TIME 1 AND 2** factory default settings are 60 seconds each.

**Note:** When a **NO SHOCK ADVISED** message occurs immediately after a shock, the CPR period is the same as CPR Time 1.

**Note:** CPR Time 0 is not available if **AUTO ANALYZE 2** is selected on AEDs that have an **ANALYZE** button or on AEDs that do not have an **ANALYZE** button. CPR Time 999 is not available on AEDs that do not have an **ANALYZE** button.

### Pulse Prompt

The **PULSE PROMPT** option only appears on AEDs distributed in the English language.

This option determines which voice prompt (and LCD message) is presented to tell the user to check the patient for signs of circulation. Checking for signs of circulation is important after a **NO SHOCK ADVISED** decision, after three sequential shocks, and after a CPR interval.

If **PULSE PROMPT 1** is selected, the following voice prompts will be heard and LCD messages displayed to prompt the user to check for signs of circulation: **CHECK FOR PULSE; IF NO PULSE, START CPR** and **CHECK FOR PULSE; IF NO PULSE, PUSH ANALYZE**.

If **PULSE PROMPT 2** is selected, the following voice prompts will be heard and LCD messages displayed to prompt the user to check for signs of circulation: **CHECK PATIENT; IF NOT MOVING AND NOT BREATHING NORMALLY, START CPR**, and **CHECK PATIENT; IF NOT MOVING AND NOT BREATHING NORMALLY, PUSH ANALYZE**.

The factory default setting is **PULSE PROMPT 1**.

### CPSS during CPR

The **CPSS DURING CPR** option determines whether or not Continuous Patient Surveillance System (CPSS) is active during CPR Time. The factory default setting is **OFF**. This setup option is only available with AEDs that have an **ANALYZE** button and are configured with **AUTO ANALYZE OFF** or **AUTO ANALYZE 1**.

If the **CPSS DURING CPR** option is **ON**, the AED "watches" for potentially shockable ECG rhythms (e.g., fibrillation) throughout CPR Time. When CPSS detects a potentially shockable ECG rhythm, the AED prompts **PUSH ANALYZE**, and CPR is temporarily interrupted while the user stays clear of the patient during the analysis. With CPSS on during CPR Time, CPR artifact may or may not be interpreted as a shockable ECG rhythm. However, when CPSS is off during CPR, the presence of a shockable ECG rhythm will not be detected until CPR Time is over or the next analysis.

The determination of whether or not the **CPSS DURING CPR** option is selected to be turned ON may be based on the following:

- Post shock CPR protocol
- Effects of interrupting CPR
- Skill and training level of the care providers

If CPSS is turned on during CPR Time, protocols should be developed to manage the possible repeated false positives of CPSS alerts during CPR. The ability of the personnel in the service to follow such a protocol should be taken into account. For more information, refer to Appendix A.



## Motion Detection

The **MOTION DETECTION** option determines whether or not the motion detection system is active during analysis. The factory default setting is **ON**.

When this option is **OFF**, analysis of the ECG is allowed to proceed uninhibited by the presence of motion, which may or may not cause artifact on the ECG. Artifact on the ECG may lead to erroneous ECG interpretations. However, when this option is on, motion that is detected may temporarily inhibit analysis from proceeding, for example in patients with agonal breathing.

The determination of whether or not the **MOTION DETECTION OPTION** is selected to be turned off includes the consideration of:

- Skill and training level of the care providers
- Frequency of the occurrence of agonal breathing
- Other motion artifact during use of the AED

For more information, refer to Appendix A.

## Asystole Detector

This option enables the **ASYSTOLE DETECTOR**. When active, the **ASYSTOLE DETECTOR** notifies the user that asystole has been detected for a number of consecutive analyses over a period of time. The time interval determines how long asystole must be detected before the **ASYSTOLE** message appears. The time intervals that can be selected are: 4 to 60 minutes (in one-minute intervals). The factory default setting is **OFF**.

## Audio Recording

**AUDIO RECORDING** is only displayed if the option is installed. The **AUDIO RECORDING** option may be **ON** or **OFF**. If it is **ON**, the AED records the audio during patient care. If it is **OFF**, the AED does not record the audio. The factory default setting is **ON**.

## Paper Size

The **PAPER SIZE** option defines the size of the paper for the printer used to print out AED data. The choices are 8 1/2 x 11 inches and A4. The factory default is 8 1/2 x 11 inches.

## Incident ID

An **INCIDENT ID** number can be entered prior to transferring patient data to a computer through a modem. You can use up to 20 characters with any combination of displayable characters. The factory default setting is **OFF**.

## Audio Alert

The **AUDIO ALERT** option determines whether or not an audible tone (beeps) sounds when the automatic self-test detects a low battery condition or a condition that requires service. The factory default setting is **OFF**. Regardless of whether the **AUDIO ALERT** is set to **ON** or **OFF**, indicators appear on the readiness display if a low battery or service condition is detected.

The **AUDIO ALERT** option is only available on AEDs with a readiness display distributed in the English language.

## Transfer Setup

Once the setup in one LIFEPAK 500 AED has been customized, the **TRANSFER SETUP** option supports the transfer of this setup to other LIFEPAK 500 AEDs. Setup transfers are possible only between LIFEPAK 500 AEDs with the same button configuration (for example, 2-button to 2-button) and defibrillation waveform.

---

## FACTORY DEFAULT SETTINGS

Factory default settings for setup options are summarized in Table 2-5.

Table 2-5 Setup Options and Factory Default Settings

Setup Options	Factory Default Settings
Device ID	Automatically generated sequence number
Modem phone number	T9W1886279698
Modem selection	5
Modem initialization string	Blank
Energy sequence	200–300–360 joules
Energy protocol	Flexible sequence
Display energy	ON
Auto analyze	1
CPR time 1	60 seconds
CPR time 2	60 seconds
Pulse Prompt	1
CPSS during CPR	OFF
Motion detection	ON
Asystole detector	OFF
Audio recording	ON
Paper size	8 1/2 x 11 inches
Incident ID	OFF
Audio alert	OFF
Transfer setup	User feature (always active)

For more information on changing setup options, refer to the *LIFEPAK 500 Automated External Defibrillator Setup Instructions* (CAT. 26500-001011).

## TRANSFERRING SETUP TO ANOTHER LIFEPAK 500 AED

You can transfer the clock setting and all setup information except **DEVICE ID** from one LIFEPAK 500 AED to an identical AED using the Transfer Setup option. Identical AEDs are devices that have the same button configuration, software version, and defibrillation waveform.

**Note:** Only LIFEPAK 500 AEDs with software version 4.2 or later can transfer and receive setup data. Attempting to transfer setup data to devices with software version 4.0 may induce erroneous faults in the receiving device.

To transfer the setup:

- 1 From within the **SETUP MODE**, push **ANALYZE** (or blank "menu" button) to advance to the transfer setup option. The AED displays the **TRANSFER SETUP** screen:

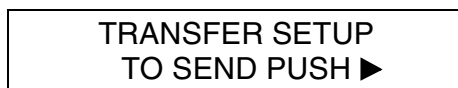

- 2 Connect the equipment as shown in Figure 2-4:
  - Connect the Setup Transfer Cable to the AED that has the setup you wish to transfer (original AED).
  - Connect the other end of the Setup Transfer Cable to the AED that you wish to receive the new setup (receiving AED).

**Note:** Both AEDs must have the same button configuration and defibrillation waveform.

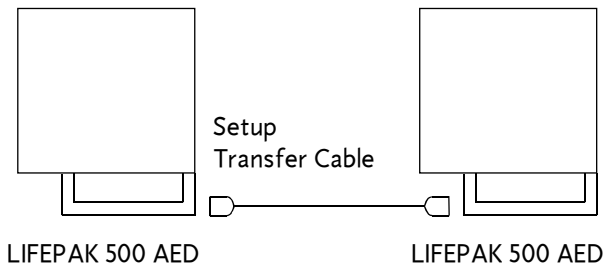

Figure 2-4 Setup transfer connections

- 3 Turn on the receiving AED and wait for **CONNECT ELECTRODES** message to appear.
- 4 Push the ► button on the original AED to send the setup to the receiving AED.
 

During setup transfer, the original AED displays the **SENDING** message. The receiving AED displays a blank screen.

After the original AED successfully transfers the setup, it displays the **SEND COMPLETE** message. The receiving AED turns itself off, turns itself back on, and then displays the **CONNECT ELECTRODES** message.
- 5 To transfer the setup from the original AED to additional AEDs:
  - Turn off the receiving AED.
  - Disconnect the Setup Transfer Cable from the receiving AED.
  - Repeat Steps 2 through 4.
- 6 When finished, disconnect the Setup Transfer Cable, turn off both AEDs, and prepare them for patient use.

**Note:** The original AED does not transfer the device ID to the receiving AED. To change the device ID on a receiving AED, refer to the *LIFEPAK 500 Automated External Defibrillator Setup Instructions* (CAT. 26500-001011).

## CONNECTING ELECTRODES TO THE AED

You can connect the QUIK-COMBO electrodes with the REDI-PAK preconnect system to the AED before patient care to save time. To connect the REDI-PAK-type QUIK-COMBO electrodes:

- 1 Inspect the electrode package and confirm that the expiration date has not passed.
- 2 Remove the clear plastic pouch to expose the QUIK-COMBO electrode connector.
- 3 Open the connector cover on the AED as shown in Figure 2-5.
- 4 Insert the electrode connector firmly into the cable connector on the AED as shown in Figure 2-5.

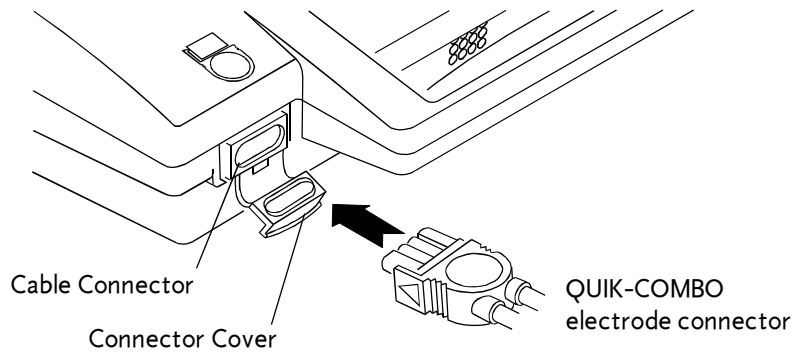

Figure 2-5 Connecting the QUIK-COMBO electrodes

- 5 Store the electrodes in the carrying case or the electrode storage tray.
- 6 Do not open the electrode package until immediately prior to patient use.

If you use QUIK-COMBO electrodes without the REDI-PAK preconnect system, you should:

- Not open the electrode package until immediately prior to patient use.
- Inspect the electrode package and confirm that the expiration date has not passed.
- Store the electrode package in the carrying case or electrode storage tray.
- When ready for patient use, open the electrode package and connect the electrodes to the AED as shown in Figure 2-5 above.

**Note:** If you are using FAST-PATCH electrodes, refer to Appendix C. If you want to use Infant/Child Reduced Energy Defibrillation Electrodes, purchase the Infant/Child Reduced Energy Defibrillation Electrodes Starter Kit (CAT. 41330-000005 or CAT. 41330-000006).

## USING THE LIFEPAK 500 AED

This section describes how to use the LIFEPAK 500 Automated External Defibrillator (AED) for ECG analysis and defibrillation. The actual clinical procedures that you use may vary according to your local protocol.

Warnings and Cautions	page 3-2
Preparing the AED for Operation	3-2
AED Operation	3-3
AED Prompts	3-5
Patient Care Transfer to a Different Device	3-10
Troubleshooting During Patient Care	3-10

---

## WARNINGS AND CAUTIONS

### WARNINGS!

#### Shock hazard.

This defibrillator delivers up to 360 joules of electrical energy. When discharging the defibrillator, do not touch the disposable therapy electrodes.

#### Shock hazard.

If a person is touching the patient, bed, or any conductive material in contact with the patient during defibrillation, the delivered energy may be partially discharged through that person. Clear everyone from contact with the patient, bed, and other conductive material before discharging the defibrillator.

#### Shock hazard.

To remove an unwanted charge, disconnect the electrode cable from the device, wait for the device to automatically remove the charge, or turn off the AED.

#### Possible fire, burns, and ineffective energy delivery.

Do not discharge standard paddles on top of therapy electrodes or ECG electrodes. Do not allow therapy electrodes to touch each other, ECG electrodes, lead wires, dressings, transdermal patches, etc. Such contact can cause electrical arcing and patient skin burns during defibrillation and may divert defibrillating energy away from the heart muscle.

#### Possible skin burns.

During defibrillation, air pockets between the skin and therapy electrodes can cause patient skin burns. Apply therapy electrodes so that entire electrode adheres to skin. Do not reposition the electrodes once applied. If the position must be changed, remove and replace with new electrodes.

#### Possible skin burns and ineffective energy delivery.

Therapy electrodes that are dried out or damaged may cause electrical arcing and patient skin burns during defibrillation. Do not use electrodes that have been removed from foil package for more than 24 hours. Do not use electrodes beyond expiration date. Check that electrode adhesive is intact and undamaged. Replace therapy electrodes after 50 shocks.

### CAUTION!

#### Possible equipment damage.

Before using this AED, disconnect all equipment from the patient that is not defibrillator-protected.

---

## PREPARING THE AED FOR OPERATION

Follow these steps to help ensure that the AED is always ready for use:

- Properly maintain the AED and batteries as described on page 5-7 of this manual.
- Make sure that the defibrillation electrodes are available and properly stored in the AED carrying case or electrode tray.
- Keep the following supplies readily accessible:
  - Spare, properly maintained battery
  - Spare defibrillation electrodes
  - Supplies to clean and shave the electrode sites on the patient
- Keep the AED and accessories within an optimal temperature range of 15–35°C (59–95°F).

QUIK-COMBO and FAST-PATCH electrodes are pre-gelled, self-adhesive electrodes that allow hands-free defibrillation. They are designed for use with devices equipped with the appropriate connector or therapy cable. For more information about these electrodes, refer to the respective electrode operating instructions.

## AED OPERATION

To prepare for ECG analysis and defibrillation:

- 1 Verify that the patient is in cardiac arrest (the patient is unconscious, not breathing normally and shows no signs of circulation, for example, no pulse, and/or no coughing, no movement).
- 2 Press **ON/OFF** to turn on the AED (the green LED will light). The **CONNECT ELECTRODES** message and voice prompt will occur until the patient is connected to the AED.
- 3 Prepare the patient for electrode placement:
  - If possible, place the patient on a hard surface away from standing water.
  - Remove clothing from the patient's upper torso.
  - Remove excessive hair from the electrode sites. If shaving is necessary, avoid cutting the skin.
  - Clean the skin and dry it briskly with a towel or gauze.
  - Do not apply alcohol, tincture of benzoin, or antiperspirant to the skin.
- 4 Apply the electrodes to the patient's chest:
  - Place the ♥ or + electrode lateral to the patient's left nipple with the center of the electrode in the midaxillary line, if possible. (See Figure 3-1.)
  - Place the other electrode on the patient's upper right torso, lateral to the sternum and below the clavicle as shown in Figure 3-1.
  - Starting from one end, press the electrodes firmly onto the patient's skin.

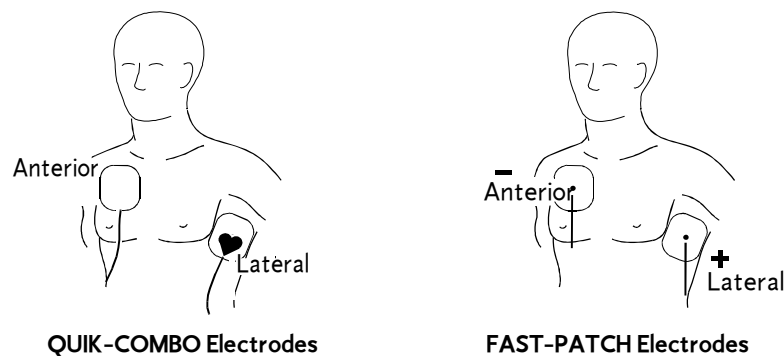

Figure 3-1 Anterior-lateral position

- 5 Connect the electrode connector to the AED (if it is not already connected).
- 6 Follow the screen messages and voice prompts provided by the AED.

If the patient recovers consciousness and/or signs of circulation and breathing return, place the patient in the recovery position and leave the AED attached.

## Special Situations for Electrode Placement

When placing electrodes on the patient, be aware of the following special situations.

### Obese Patients or Patients with Large Breasts

Apply the electrodes to a flat area on the chest, if possible. If skin folds or breast tissue prevent good adhesion, spread skin folds apart to create a flat surface.

### Thin Patients

Follow the contour of the ribs and spaces when pressing the electrodes onto the torso. This limits air space or gaps under the electrodes and promotes good skin contact.

#### WARNING!

Possible interference with implanted electrical device.

Defibrillation may cause implanted electrical devices to malfunction. Place therapy electrodes away from implanted devices if possible. Check implanted device function after defibrillation.

### Patients with Implanted Pacemakers

If possible, place defibrillation electrodes away from the internal pacemaker generator. Treat this patient like any other patient requiring emergency care. Pacemaker pulses may prevent advisement of an appropriate shock, regardless of the patient's underlying rhythm.

### Patients with Implanted Defibrillators

Apply the electrodes in the anterior-lateral position. Treat this patient like any other patient requiring emergency care.

### Alternate Anterior-Posterior Electrode Position

The electrodes may be placed in an anterior-posterior position as follows:

- 1 Place either the ♥ or + therapy electrode over the left precordium as shown in Figure 3-2. The upper edge of the electrode should be below the nipple. Avoid placement over the nipple, the diaphragm, or the bony prominence of the sternum if possible.
- 2 Place the other electrode behind the heart in the infrascapular area as shown in Figure 3-2. For patient comfort, place the cable connection away from the spine. Do not place the electrode over the bony prominences of the spine or scapula.

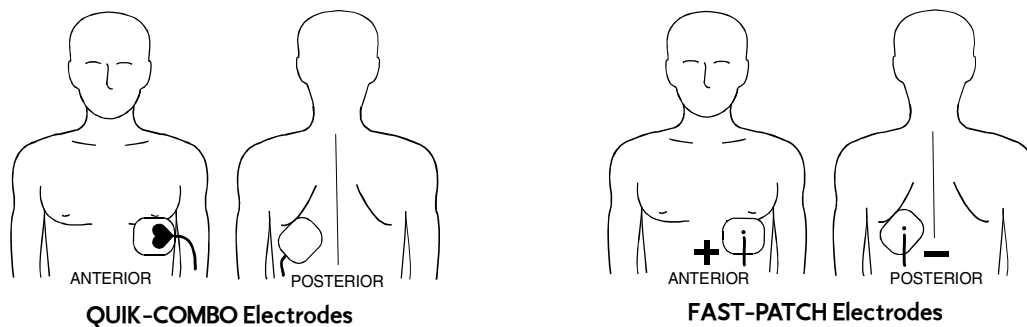

Figure 3-2 Anterior-posterior placement



## AED PROMPTS

The following paragraphs describe typical scenarios that might occur during AED operation. Topics include:

- First analysis cycle
- Shock advised
- Subsequent analysis cycles
- No shock advised
- CPR Time
- Shock counter
- Motion detection
- Continuous Patient Surveillance System - Check Patient Alert
- Electrodes off detection

For a more detailed description of how the AED analyzes the patient ECG, refer to page A-3.

**Note:** Accent marks are not included in message prompts for international languages.

### WARNING!

#### Possible misinterpretation of data.

Do not analyze in a moving vehicle. Motion artifact may affect the ECG signal resulting in an inappropriate shock or no shock advised message. Motion detection may delay analysis. Stop vehicle and stand clear of patient during analysis.

#### Possible misinterpretation of data.

Do not move the AED during analysis. Moving the AED during analysis may affect the ECG signal resulting in an inappropriate shock or no shock advised decision. Do not touch the patient or the AED during analysis.

## First Analysis Cycle

When you turn on the power and first apply electrodes to the patient, the AED will either analyze automatically or prompt you to press **ANALYZE**, depending on the auto analyze configuration.

If you hear the **PUSH ANALYZE** voice prompt and see the **ANALYZE** LED flash, press **ANALYZE**.

When the AED begins to analyze the patient's ECG, the AED beeps twice and alternately displays two messages:

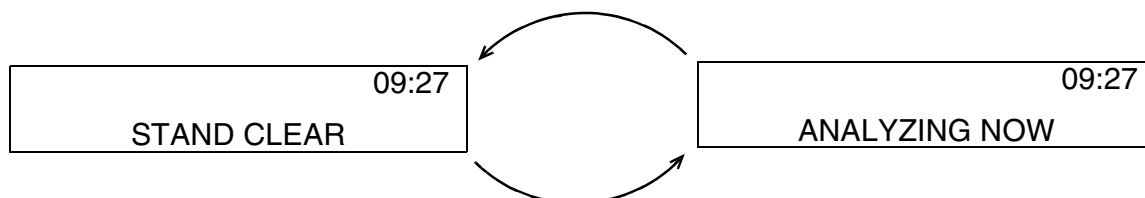

You will hear the **STAND CLEAR, ANALYZING NOW, STAND CLEAR** voice prompt. The ECG analysis requires about 9 to 13 seconds. The **ANALYZE** LED (if present) is on during analysis.

### Shock Advised

If the AED detects a shockable ECG rhythm, it displays this message:



You will hear the **SHOCK ADVISED** voice prompt. The AED begins charging for Shock #1. A rising tone indicates that the AED is charging.

When charging is complete, the AED alternately displays two messages:

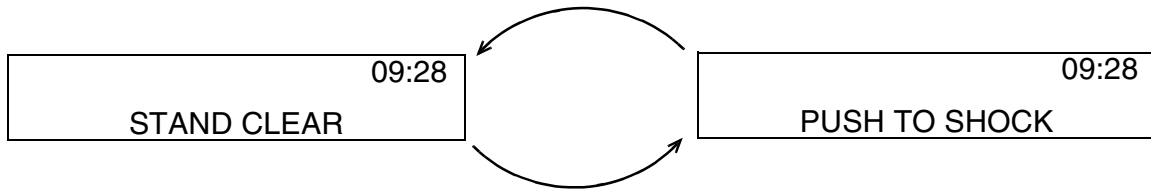

You will hear the **STAND CLEAR, PUSH TO SHOCK** voice prompt followed by the “shock ready” tone (a loud, high-pitched, two-tone sound). The **SHOCK LED** flashes.

- Check that no one is touching the patient.
- Press **SHOCK** to discharge the AED.
- If you do not press **SHOCK** within 15 seconds, the AED disarms the **SHOCK** button, and the **CHARGE REMOVED** message appears.

### Subsequent Analysis Cycles

If the option **AUTO ANALYZE 1** or **2** is selected, the AED automatically analyzes the patient’s ECG rhythm after Shock #1 is delivered. If the **AUTO ANALYZE** option is off, the AED displays **PUSH ANALYZE** after Shock #1. (You will also hear the **PUSH ANALYZE** voice prompt and see the **ANALYZE LED** flash.) You must press **ANALYZE** to begin the analysis.

The second analysis and shock sequence is the same as that described for Shock #1. However, the energy levels for Shock #2 and Shock #3 depend on the value selected for the **ENERGY SEQUENCE** and the **ENERGY PROTOCOL** options. When a **NO SHOCK ADVISED** decision immediately follows a shock, the energy level will not increase for the next shock if **FLEXIBLE SEQUENCE** is enabled.

**Note:** If **FIXED SEQUENCE** is enabled, the energy level for shocks will increment regardless of the analysis decision.

### No Shock Advised

If the AED detects a nonshockable ECG rhythm, it displays this message:



You will hear the **NO SHOCK ADVISED** voice prompt. The AED will not charge, and no shock can be delivered.

After **NO SHOCK ADVISED**, the AED enters **CPR TIME** if **CPR TIME** is set to 15 seconds or more. If **CPR TIME** is set to 0, the AED displays one of the following message sequences, depending on the **PULSE PROMPT** selected in Setup:

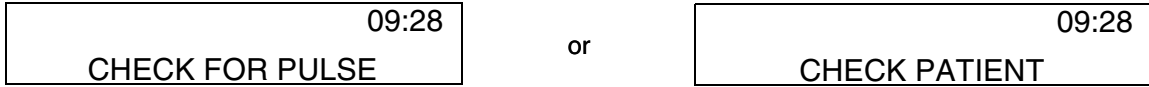

You will hear the corresponding voice prompt. Within 10 seconds, the AED displays two alternating messages:

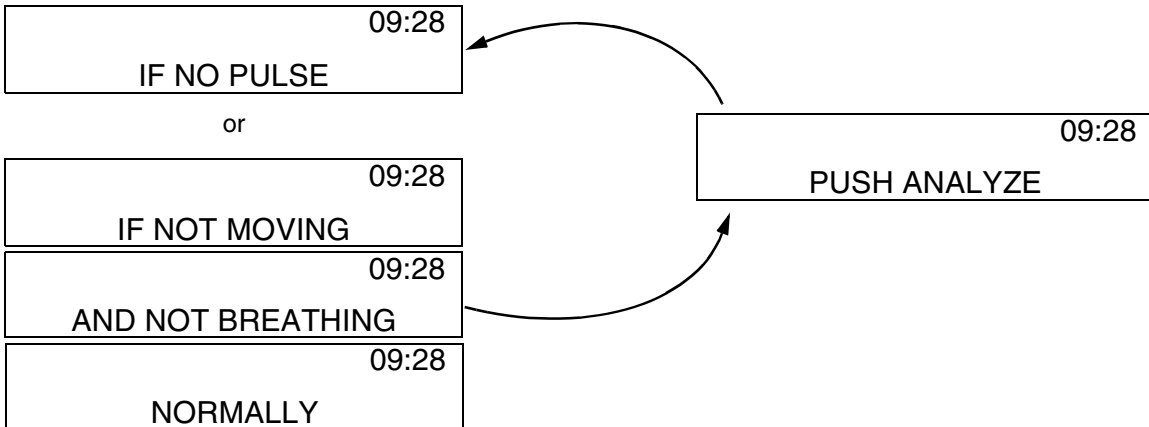

You will hear the corresponding voice prompt.

**CPR Time**

At the beginning of **CPR TIME**, the AED first displays one of the following message sequences, depending on the **PULSE PROMPT** selected in Setup:

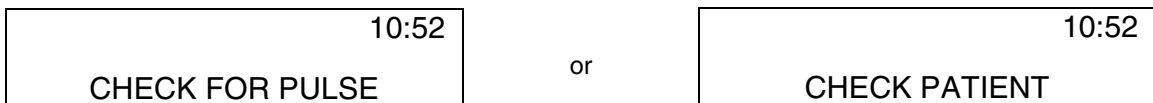

You will hear the corresponding voice prompt.

The AED then alternately displays two messages.

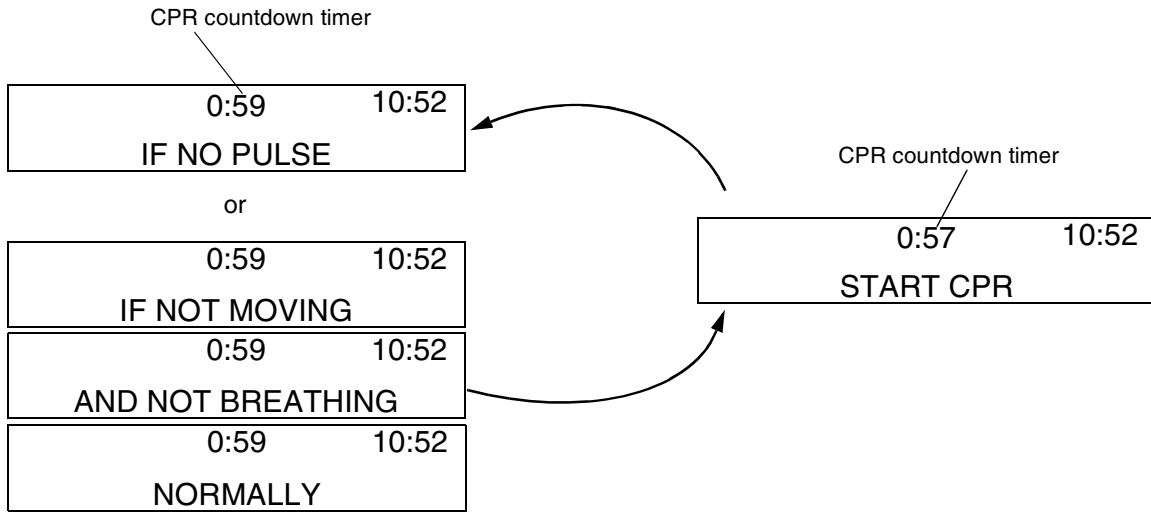

The CPR countdown timer indicates CPR time remaining.

You will hear the corresponding voice prompt. If **CPR TIME** is set to 15, 30, 45, 60, 90, 120, or 180 seconds, the messages alternate for the remaining **CPR TIME**. You can press **ANALYZE** (if button present) to stop **CPR TIME** and start an analysis cycle.

If **CPR TIME** is set to 999 (infinite **CPR TIME**), the AED displays the above messages, but does not display the CPR timer. The messages alternate without further voice prompts. You can press **ANALYZE** (if button present) to stop **CPR TIME** and start an analysis cycle at any time.

### After CPR Time

After **CPR TIME**, the AED displays one of the following message sequences, depending on the **PULSE PROMPT** selected in Setup:

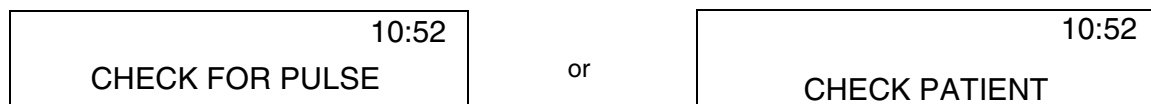

You will hear the corresponding voice prompt. Within 10 seconds, the AED displays two alternating messages if **AUTO ANALYZE** is off or **AUTO ANALYZE 1** is selected:

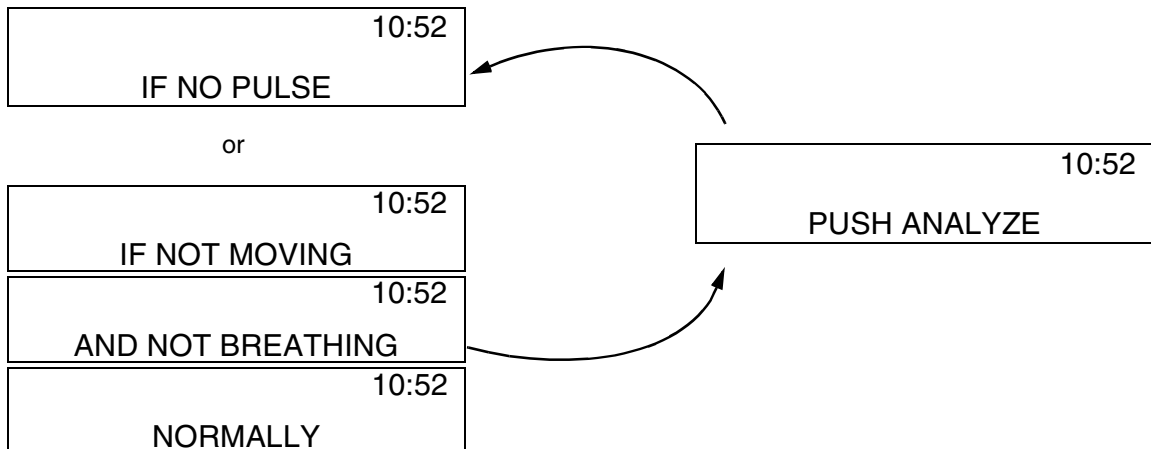

You will hear the corresponding voice prompt.

**Note:** If **AUTO ANALYZE 2** is selected or for LIFEPAK 500 AEDs that do not have an **ANALYZE** button, analysis will begin automatically at the end of CPR Time. You will hear **STAND CLEAR, ANALYZING NOW, STAND CLEAR**. Stop CPR immediately and stay clear of patient during the analysis.

### Shock Counter

The AED displays the shock counter in the upper-left corner of the LCD:

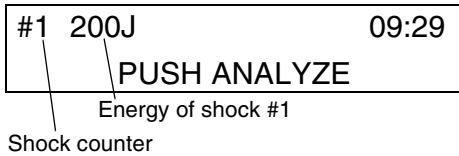

The shock counter indicates how many shocks have been delivered to the patient. Following the shock counter, the energy for that shock number may be displayed (optional). The shock counter resets whenever the AED is turned off for at least 60 seconds.

### Motion Detection

If the AED is configured with **MOTION DETECTION ON** and the AED detects motion during the ECG analysis, the AED alternately displays two messages:

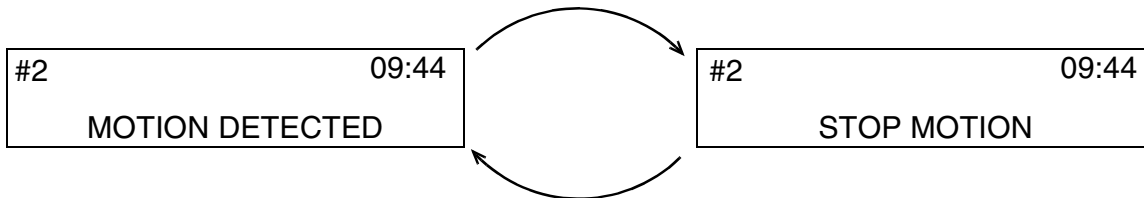

You will hear the **MOTION DETECTED, STOP MOTION** voice prompt, followed by a warning tone. If the motion ceases within 20 seconds, analysis will continue. If the motion does not cease within 20 seconds, analysis will stop. You must then push **ANALYZE** (if button present) to restart analysis. If **AUTO ANALYZE 2** is selected and in LIFEPAK 500 AEDs that do not have an **ANALYZE** button, analysis will restart automatically. Refer to troubleshooting on page 6-2 for possible causes and suggested actions.

If the AED is configured with **MOTION DETECTION OFF**, the ECG analysis proceeds uninhibited by the presence of motion. There is no motion detected verbal or text prompt if motion is present during ECG analysis.

### Continuous Patient Surveillance System – Check Patient Alert

The Continuous Patient Surveillance System (CPSS) is active immediately after the AED is turned on when the patient is connected, and after CPR time. In addition, CPSS may be configured to be active during CPR time.

**Note:** CPSS is not active if **AUTO ANALYZE 2** is selected or in LIFEPAK 500 AEDs without an **ANALYZE** button.

If the CPSS detects a potentially shockable rhythm, the AED displays this message:



You will hear the **PUSH ANALYZE** voice prompt accompanied by a warning tone. You should:

- Stop all patient and vehicle movement.
- Confirm that the patient is in cardiac arrest.
- Press **ANALYZE**. Stay clear of the patient and allow the AED to analyze the patient's rhythm.
- Follow the screen messages and voice prompts provided by the AED.

### Electrodes Off Detection

If the AED detects that the electrodes are not properly connected to the AED or the patient, the AED displays this message:



You will hear the **CONNECT ELECTRODES** voice prompt followed by three warning beeps. Refer to troubleshooting on page 6-2 for possible causes and suggested actions.

### Asystole Detector

If the AED has been configured for the asystole detector to be active, the AED displays this message after **NO SHOCK ADVISED** decisions occur with asystole present and when the asystole detector time interval has been reached.



You will hear the **ASYSTOLE** voice prompt, which will repeat periodically until the next analysis.

---

## PATIENT CARE TRANSFER TO A DIFFERENT DEVICE

To transfer patient care between devices equipped with identical therapy cable connectors:

- 1 Turn off the device connected to the patient.
- 2 Leave the defibrillation electrodes on the patient; disconnect the electrodes from the therapy cable or the device.
- 3 Connect the therapy electrodes to the next device.

To transfer patient care between devices not equipped with identical therapy cable connectors:

- 1 Turn off the device connected to the patient.
- 2 Remove the defibrillation electrodes currently on the patient.
- 3 Apply defibrillation electrodes that are compatible with the receiving device.
- 4 Follow the instructions for the receiving device.

---

## TROUBLESHOOTING DURING PATIENT CARE

For troubleshooting during patient care, refer to Table 6-1 on page 6-2.

## DATA MANAGEMENT

This section describes how to store and transfer LIFEPAK 500 Automated External Defibrillator (AED) data to a computer or a modem. Topics include:

Overview of Data Storage and Retrieval	page 4-2
Sending Data to a Computer by Modem	4-5
Sending Data to a Computer by Direct Connection	4-8
Sending Data to a Printer	4-9

---

## OVERVIEW OF DATA STORAGE AND RETRIEVAL

Every time you use the LIFEPAK 500 AED on a patient, data is stored digitally inside the AED. This data allows post-incident review for quality control, training, and research purposes. Print or transfer this data as soon as possible to save the information.

The following paragraphs describe how the LIFEPAK 500 AED stores and retrieves data.

### Overview of Data Storage

Whenever power is on, the LIFEPAK 500 AED automatically stores the data illustrated in Figure 4-1.

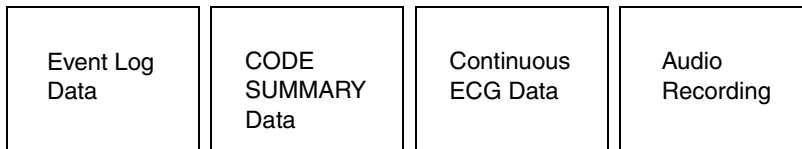

Figure 4-1 Data stored by the LIFEPAK 500 AED

- **Event Log Data** — A chronological log of all events. An event is a specific action by the operator or AED, such as:
  - Power on
  - Patient connected
  - Analysis started
  - Shock advised
  - Shock deliveredRefer to page 6-8 for a list of all the event types.
- **CODE SUMMARY™ Data** — A summary of critical resuscitation events and the ECG rhythm segments associated with those events.
- **Continuous ECG Data** — Between 20 and 80 minutes of the patient ECG rhythm from the time of power-on to power-off. Varies with the configuration of the AED and whether Audio Recording is installed and enabled. (Refer to Specifications, page 5-15.) Data collection stops when maximum recording times are exceeded.
- **Audio Recording** — Approximately 20 minutes of audio data recorded at the scene, such as operator remarks and AED voice prompts or tones. (The audio recording option must be installed and enabled.) Data collection stops when maximum recording times are exceeded.

### Patient Records

A patient record is created when the AED is connected to a patient and begins to store data. The AED stores data from the time that you turn the AED on until you turn the AED off. The LIFEPAK 500 AED can store a maximum of two patient records:

- **Current Patient** — The most recent patient record stored
- **Previous Patient** — The patient record stored prior to the Current Patient

The data stored for the Current Patient and Previous Patient is illustrated in Figure 4-2.



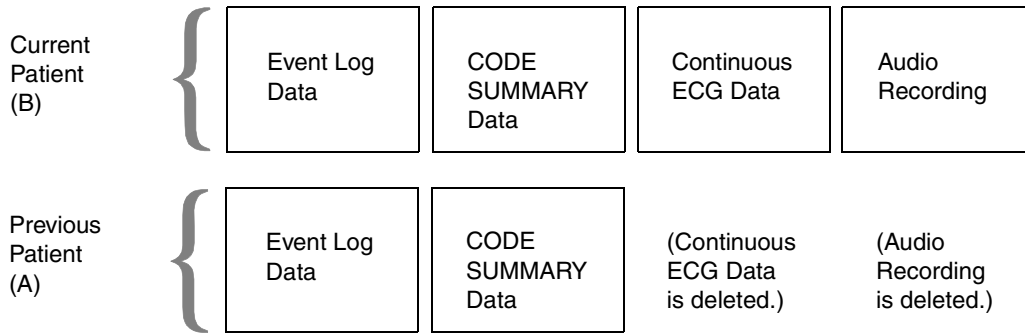

Figure 4-2 Comparison of data stored for the Current Patient and Previous Patient

The AED stores all data for the Current Patient (B). However, the AED only retains the Event Log and CODE SUMMARY data for the Previous Patient (A).

**Information Stored When Creating a New Patient Record**

When the AED creates a new patient record, the following occurs:

- The AED stores all data for the newest patient record, Patient C (refer to Figure 4-3). Patient C is now the Current Patient.
- The AED deletes the ECG and audio recording data for Patient B. The AED retains only the Event Log and CODE SUMMARY data. Patient B is now the Previous Patient.
- The AED deletes all data for the oldest patient record, Patient A.

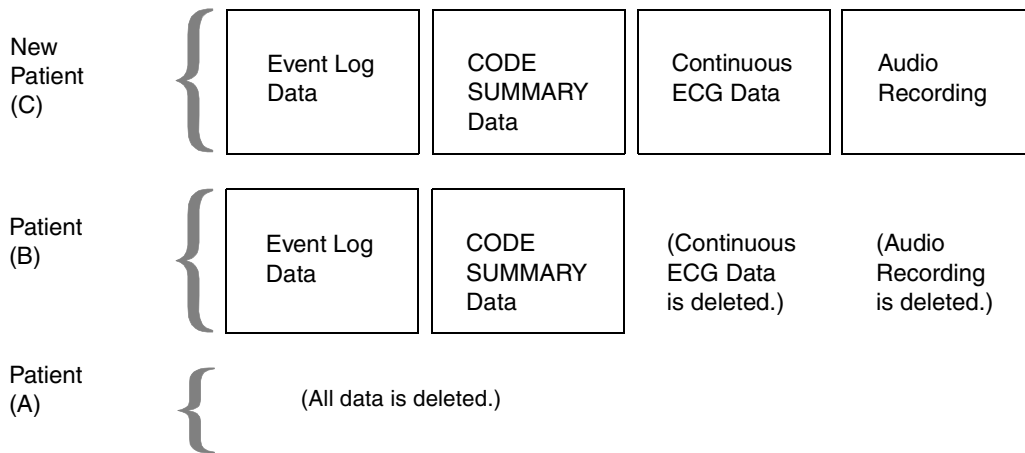

Figure 4-3 Data stored when the AED stores a new patient record

**Conditions for Creating a New Patient Record**

To begin a new patient record, the following conditions must occur:

- The AED must be turned off for at least 60 seconds, then turned on.
- Electrodes must be connected to the patient.

You can turn off the AED briefly without affecting the Current Patient. For example, you can change the battery. If you restore power in less than 60 seconds, the AED resumes storing data for the Current Patient.

If you do not connect electrodes to a patient or a simulator, you can turn on the AED and not affect the Current Patient. For example, you can turn on the AED to test it with the external test load or to transfer data. As long as you do not connect the electrodes to a new patient or an ECG simulator, the AED does not create a new patient record.

As soon as you turn on the AED, the AED begins storing data for a new patient record. However, if you do not connect electrodes to a patient within 3 minutes, the AED stops storing data.

- If you then connect electrodes, the AED resumes storing data and creates a new Current Patient.
- If, however, you turn off the AED without ever connecting the electrodes, the AED does *not* create a new Current Patient. The AED will delete the initial 3 minutes of data, and all previously stored data will remain unchanged. This prevents erasing data each time you turn on the AED to transfer data or perform maintenance.

### Test Log

The LIFEPAK 500 AED also stores a Test Log, a list of the 30 most recent auto-tests and manual tests. The Test Log lists the test results and any fault codes detected. The Test Log is printed automatically when data is sent to a printer. As an option, the Test Log may be printed from a computer.

### Overview of Data Retrieval

There are three ways you can retrieve data from the LIFEPAK 500 AED:

- Send the data to a computer by modem.
- Send the data to a computer by direct connection.
- Send the data to a printer.

The AED does not delete data after it is transferred. Data is only deleted when new patient records are created. Table 4-1 describes the stored data and how you can retrieve it.

Table 4-1 LIFEPAK 500 AED Data and Retrieval

Type of Data	Retrieval	Modem	Computer	Printer
Event Log Data		Yes	Yes	Yes
CODE SUMMARY data		Yes	Yes	Yes
Continuous ECG*		Yes	Yes	No
Audio Recording <sup>†</sup>		Yes <sup>2</sup>	Yes <sup>2</sup>	No
Test Log		Yes	Yes	Yes

\* Available for the Current Patient only.

<sup>†</sup> To play the audio recordings, a sound card, sound card software, and the QUIK-VIEW 500 data review program or CODE-STAT Suite must be installed in the computer.

## SENDING DATA TO A COMPUTER BY MODEM

These paragraphs describe the resources, equipment connections, and procedures required to send LIFEPAK 500 AED data to a computer by modem.

### Required Resources

Table 4-2 summarizes the resources required to send data to a computer by modem.

Table 4-2 Required Resources for Sending Data to a Computer by Modem

Description	
<b>Required Resources at Local Site</b>	
Modem Cable (for use with LIFEPAK 500 AED)	
Modem that supports the TIA/EIA-602 command set	
Modem power cord or power adapter (if required)	
Telephone cord (with RJ11 connectors)	
Analog telephone line*	
<b>Required Resources at Destination Site</b>	
Modem that supports the Hayes AT command set	
Personal Computer:	<ul style="list-style-type: none"> <li>– QUIK-VIEW 500 data review program or CODE-STAT Suite data management system</li> <li>– Microsoft Windows 3.1 or later for Data Transfer 500, and for QUIK-VIEW 500 if audio review is not needed. Microsoft Windows 95 for QUIK-VIEW 500 if audio review is needed</li> <li>– Microsoft Windows 95 or Windows NT 4.0 for CODE-STAT Suite 3.2 or earlier and Windows 98, Windows ME, Windows 2000 Professional, or Windows NT version 4.0 with Service Pack 1 for CODE-STAT Suite 4.0 or later.</li> </ul>
Cables as required	
Analog telephone line*	

\* Most internal telephone lines for integrated office telephone systems are digital lines. Make sure that you connect the modem to an external analog telephone line like the type used for fax machines.

### Setup Options

Make sure that the AED setup options are properly defined for the modem initialization string and destination phone number. Refer to page 2-8 for information about the modem setup options.

**Note:** Remember to include in the dial string any special characters that are required to dial the destination (such as "9" or a pause).

### Procedure for Sending Data

Perform these steps to send data:

- 1 Make sure that the equipment at the destination site is properly connected.
- 2 Make sure that the destination computer power is on and that the QUIK-VIEW 500 data review program or CODE-STAT Suite program is ready to receive data.
- 3 Make sure that the modem is off and that the AED is turned off for at least 60 seconds.
- 4 At the local site, connect the equipment as shown in Figure 4-4.
  - Connect the modem cable to the AED and the modem.
  - Connect the telephone cord to the modem and the analog telephone line.
  - Connect the modem power cord or power adapter to a power source (if required).

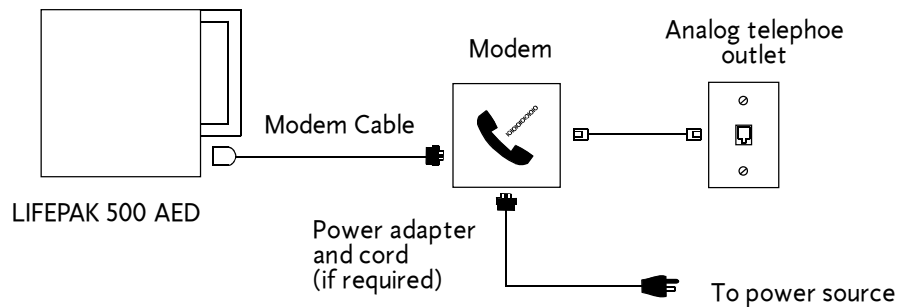

Figure 4-4 Equipment connections for data transfer by modem

- 5 Turn on the modem.
- 6 Press **ON/OFF** to turn on the AED. You will see:
  - BATTERY** status message
  - SELF-TEST** xx.xx message
- 7 After a few seconds, you will see the message:
  - TO SEND PUSH ►**
    - Press ► to send the Current Patient.
    - Press ▲ to send the Previous Patient.
    - Press both ► and ▲ to send the Current and Previous Patients.
- 8 If the incident ID option is **ON** and an Incident ID has *not* already been entered for the Current or Previous Patient, you will see the message:
  - ENTER CURRENT [ or PREVIOUS] ID?**
  - YES**
    - Press **ANALYZE** (or the blank "menu" button) to answer **YES**; or
    - Press ▲ to change to **NO**. Then press **ANALYZE** (or the blank "menu" button) and continue with step 10.

9 If you answered **YES**, you will see the message:

**INCIDENT ID**  
XXXXXXXXXX

- Press ▲ to scroll through and select from the alphanumeric characters available.
- Press ► to advance to the next field.
- Repeat this process until the Incident ID is entered.
- Press **ANALYZE** (or the blank "menu" button) to accept the Incident ID.

**Note:** The last Incident ID entered will always be displayed.

10 Verify Incident ID entered. You will see the message:

XXXXXXXXXX  
**OK TO SEND? YES**

- Press **ANALYZE** (or blank "menu" button) to accept and send the Incident ID.
- Press ▲ to change to **NO**.
- Press **ANALYZE** (or blank "menu" button) to return to Incident ID screen.
- Follow step 9 beginning with bulleted items to change the Incident ID.

11 After **ANALYZE** (or the blank "menu" button) is pressed, the AED transfers the patient data. While the data is being transferred, the AED displays the following message to indicate progress:

**SENDING**  
XX%COMPLETE

After the AED successfully completes the data transfer, it displays the **SEND COMPLETE** message.

12 After the AED displays the **SEND COMPLETE** message, check that the low battery indicator is not displayed.

13 Turn off the AED and prepare it for the next patient use.

**Note:** If you leave the LIFEPAK 500 AED unattended during data transfer, the AED automatically turns off after 15 minutes of no activity (after data transfer completed).

If the AED turns off, check the data transfer status:

- 1 Leave the data cable connected to AED and modem.
- 2 Turn on AED and look for the **SEND COMPLETE** message. If the **CANNOT SEND** message appears, refer to Table 6-2 on page 6-3 for troubleshooting tips.
- 3 If the **SEND COMPLETE** message appears:
  - Check that the low battery indicator is not displayed.
  - Disconnect the data transfer cable.
- 4 Turn off the AED and prepare it for the next patient use.

## SENDING DATA TO A COMPUTER BY DIRECT CONNECTION

These paragraphs describe the resources, equipment connections, and procedures required to send AED data to a computer by direct connection.

### Required Resources

Table 4-3 summarizes the resources required to send data to a computer by direct connection.

Table 4-3 Required Resources for Sending Data to a Computer by Direct Connection

Description
PC Cable (for use with the LIFEPAK 500 AED)
Personal Computer: <ul style="list-style-type: none"> <li>– QUIK-VIEW 500 data review program or CODE-STAT Suite data management system.</li> <li>– Microsoft Windows 3.1 or later for Data Transfer 500, and for QUIK-VIEW 500 if audio review is not needed. Microsoft Windows 95 for QUIK-VIEW 500 if audio review is needed.</li> <li>– Microsoft Windows 95 or Windows NT 4.0 for CODE-STAT Suite 3.2 or earlier and Windows 98, Windows ME, Windows 2000 Professional, or Windows NT version 4.0 with Service Pack 1 for CODE-STAT 4.0 or later.</li> </ul>

### Procedure for Sending Data

Perform these steps to send data:

- 1 Make sure that the AED is turned off for at least 60 seconds.
- 2 Connect the equipment as shown in Figure 4-5.
- 3 Make sure that the computer power is on and that the application program is open.
- 4 Press **ON/OFF** to turn on the AED. The **CONNECT ELECTRODES** message appears and remains until data transfer begins.

The computer controls the data transfer. Refer to the application program operating instructions for information about data transfer commands. The AED will not display any status messages during the data transfer.

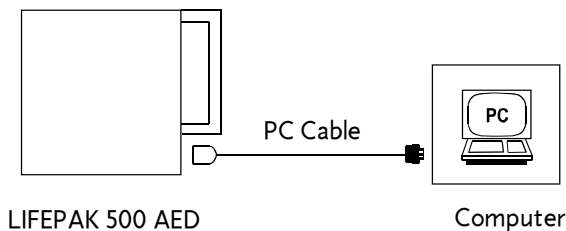

Figure 4-5 Equipment connections for data transfer by direct connection to a computer

- 5 When the computer is finished receiving data, do the following:
  - Check that the **LOW BATTERY** indicator is not displayed.
  - Disconnect the PC cable.
- 6 Turn off the AED and prepare it for the next patient use.

**Note:** If you leave the LIFEPAK 500 AED unattended during data transfer, the AED automatically turns off after 15 minutes of no activity (after data transfer completed).

If the AED turns off, check the data transfer status:

- 1 Check that the computer application program dialog box indicates that the patient record has been received. If the patient record has not been received, reinitiate procedure for sending data.
- 2 Turn on AED and check that the low battery indicator is not displayed.
- 3 Turn off the AED and prepare it for the next patient use.

### Troubleshooting During Data Transfer

If you cannot transfer data, refer to the application program operating instructions for troubleshooting information.

---

## SENDING DATA TO A PRINTER

These paragraphs describe the resources, equipment connections, and procedures required to print AED data on a printer.

### Required Resources

Table 4-4 summarizes the resources required to print AED data.

Table 4-4 Required Resources for Printing Data

Description
Printer Cable (for use with the LIFEPAK 500 AED)
Printer (EPSON® LX-300-compatible): <ul style="list-style-type: none"> <li>– EPSON ESC/P® protocol for 9-pin printheads</li> <li>– 25-pin D style connector</li> </ul>

### Procedure for Printing

Perform these steps to print AED data:

- 1 Make sure that the AED is turned off for at least 60 seconds.
- 2 Make sure that the printer is turned on.
- 3 While holding down the ► button, press ON/OFF to turn on the AED. Do not release the ► button until the AED displays:

**BATTERY** status message  
**SELF-TEST** xx.xx message

- 4 Connect the equipment as shown in Figure 4-6.
  - Connect the Printer Cable to the AED and the printer.

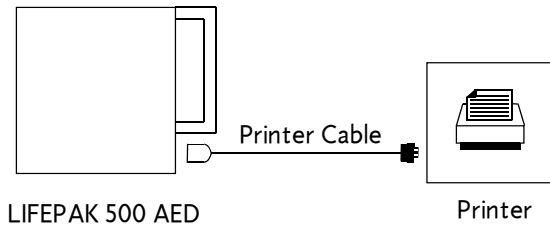

Figure 4-6 Connecting the AED to a printer

- 5 After a few seconds, you will see the message:  
**TO PRINT PUSH ►**
  - Press ► to print the Current Patient.
  - Press ▲ to print the Previous Patient.
  - Press both ► and ▲ to print the Current and Previous Patients.

While the data is being transferred, the AED displays the following message to indicate progress:

**SENDING**

After the AED successfully completes the data transfer, it displays the **SEND COMPLETE** message.

- 6 Check that the **LOW BATTERY** indicator is not displayed.
- 7 Disconnect the Printer Cable.
- 8 Turn off the AED and prepare it for the next patient use.

### Troubleshooting During Printing

If the data does not print, refer to Table 6-3 on page 6-4 for troubleshooting tips.

### Examples of Printed Reports

The following pages present examples of printed reports:

- Figure 4-7, page 4-12                      Event Log Report and Event Log Summary
- Figure 4-8, page 4-13                      CODE SUMMARY Report
- Figure 4-11, page 4-16                      Test Log Report

You cannot modify the format of the reports that the AED sends directly to the printer.

### Event Log Report

This report lists all of the events that occurred during a patient use. The clock time and elapsed time are listed for each event. The box at the top of the report includes device and patient information. Some of the entries, such as the patient ID and name, are always blank for reports printed directly from the AED. (If you send AED data to a computer, the Data Transfer 500 program, QUIK-VIEW 500 data review program, or CODE-STAT Suite data management system allows you to fill in the blank spaces with information.)



### **Event Log Summary**

This report summarizes important events for a particular patient record.

### **CODE SUMMARY Report**

This report includes the ECG segments associated with key events such as analysis or shock.

### **Test Log Report**

This report lists the time and results of the Auto Tests (**AUTO TEST**) and Test Load Tests (**MANUAL TEST**). If a test fails, the report lists fault codes that can help authorized service personnel troubleshoot and repair the AED.

Event Log Report		
Incident ID No:	Patient ID No:	
Incident Date: 15MAY04	Patient Name:	
Operator ID No:	Age:	
Device Type: LIFEPAK 500	Sex:	
Device Serial No: 00001203	Race:	
Device ID: RFD#6	Software REV: 3005360-000 REV. 4.4	
25mm/SEC, 1.0 cm/mV	Configuration: 00000000	

00:00	09:47:08	POWER ON
01:07	09:48:15	PATIENT CONNECTED
01:07	09:48:15	"PUSH ANALYZE"
01:10	09:48:18	ANALYSIS 1
01:16	09:48:24	SHOCK ADVISED
01:25	09:48:33	"PUSH TO SHOCK"
01:25	09:48:33	SHOCK 1 - 200J
01:30	09:48:38	ANALYSIS 2
01:36	09:48:44	NO SHOCK ADVISED
01:39	09:48:47	CPR PROMPT
02:39	09:49:47	"PUSH ANALYZE"
03:03	09:50:11	CHECK PATIENT
03:03	09:50:11	"PUSH ANALYZE"
03:05	09:50:13	ANALYSIS 3
03:11	09:50:19	SHOCK ADVISED
03:21	09:50:29	"PUSH TO SHOCK"
03:36	09:50:44	CHARGE REMOVED
03:40	09:50:48	ANALYSIS 4
03:46	09:50:54	NO SHOCK ADVISED
03:47	09:50:55	CPR PROMPT
03:52	09:51:00	LOW BATTERY
04:10	09:51:18	BATTERY REMOVED
04:43	09:51:51	POWER ON
04:43	09:51:51	BATTERY REPLACED
04:47	09:51:55	"PUSH ANALYZE"
04:50	09:51:58	ANALYSIS 5
04:52	09:52:00	POWER OFF

Event Log Summary	
01:10	FIRST ANALYSIS
01:25	FIRST SHOCK
	1 SHOCK DELIVERED

Comments: \_\_\_\_\_  
\_\_\_\_\_  
\_\_\_\_\_  
\_\_\_\_\_

END OF REPORT PAGE 1

Figure 4-7 Example of Event Log Report and Event Log Summary



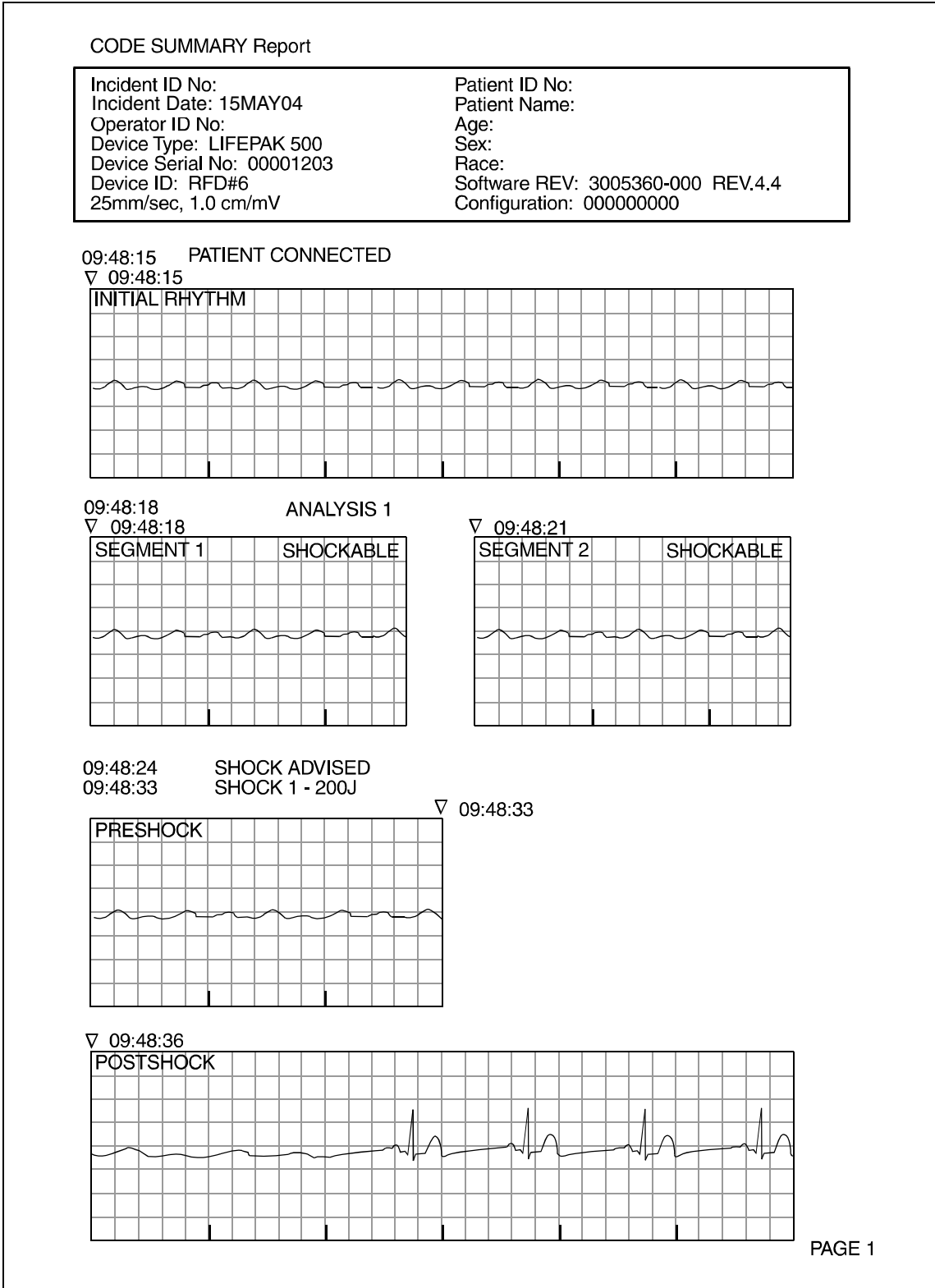

Figure 4-8 Example of CODE SUMMARY Report

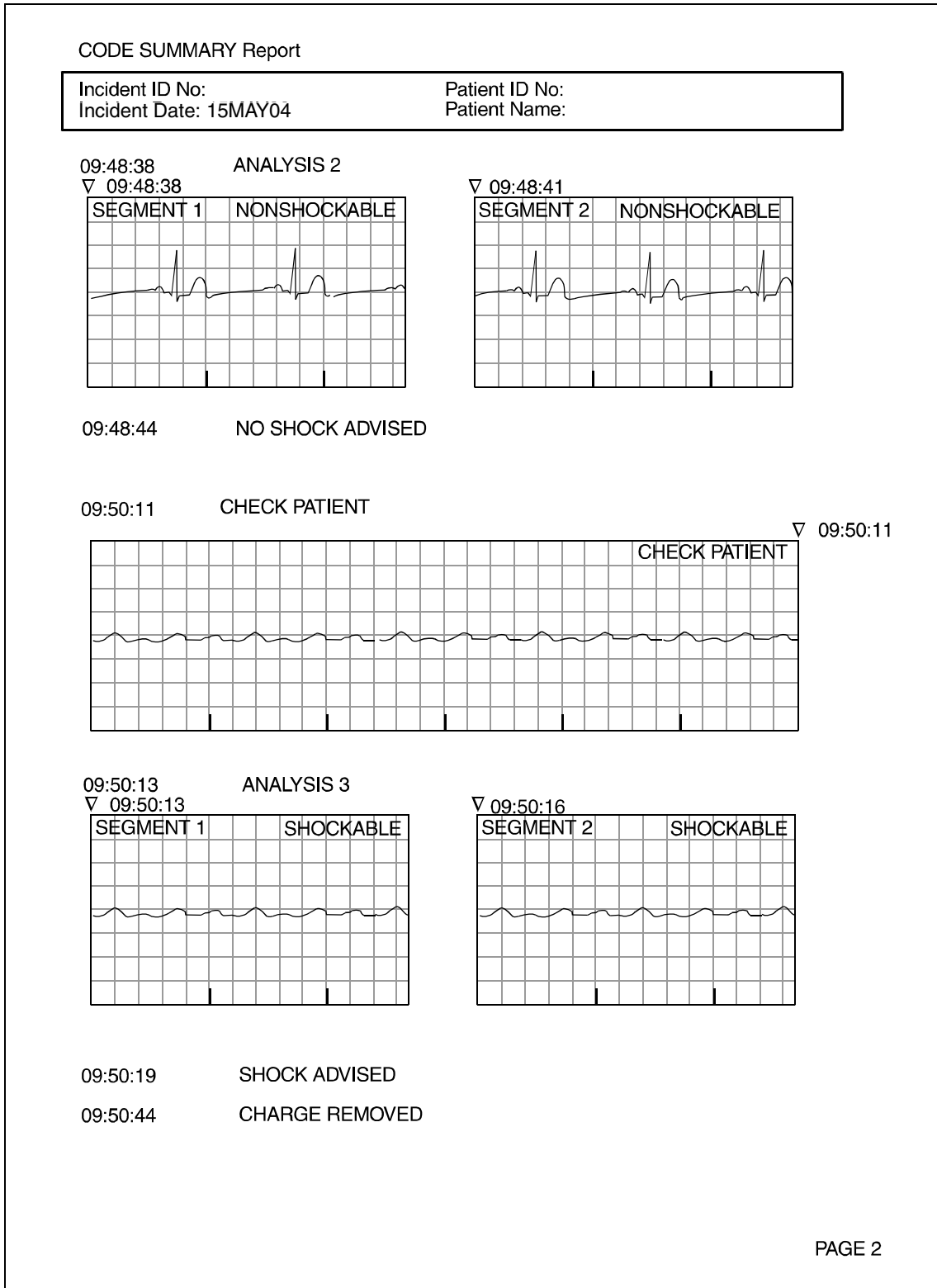

Figure 4-9 Example of CODE SUMMARY Report (cont.)

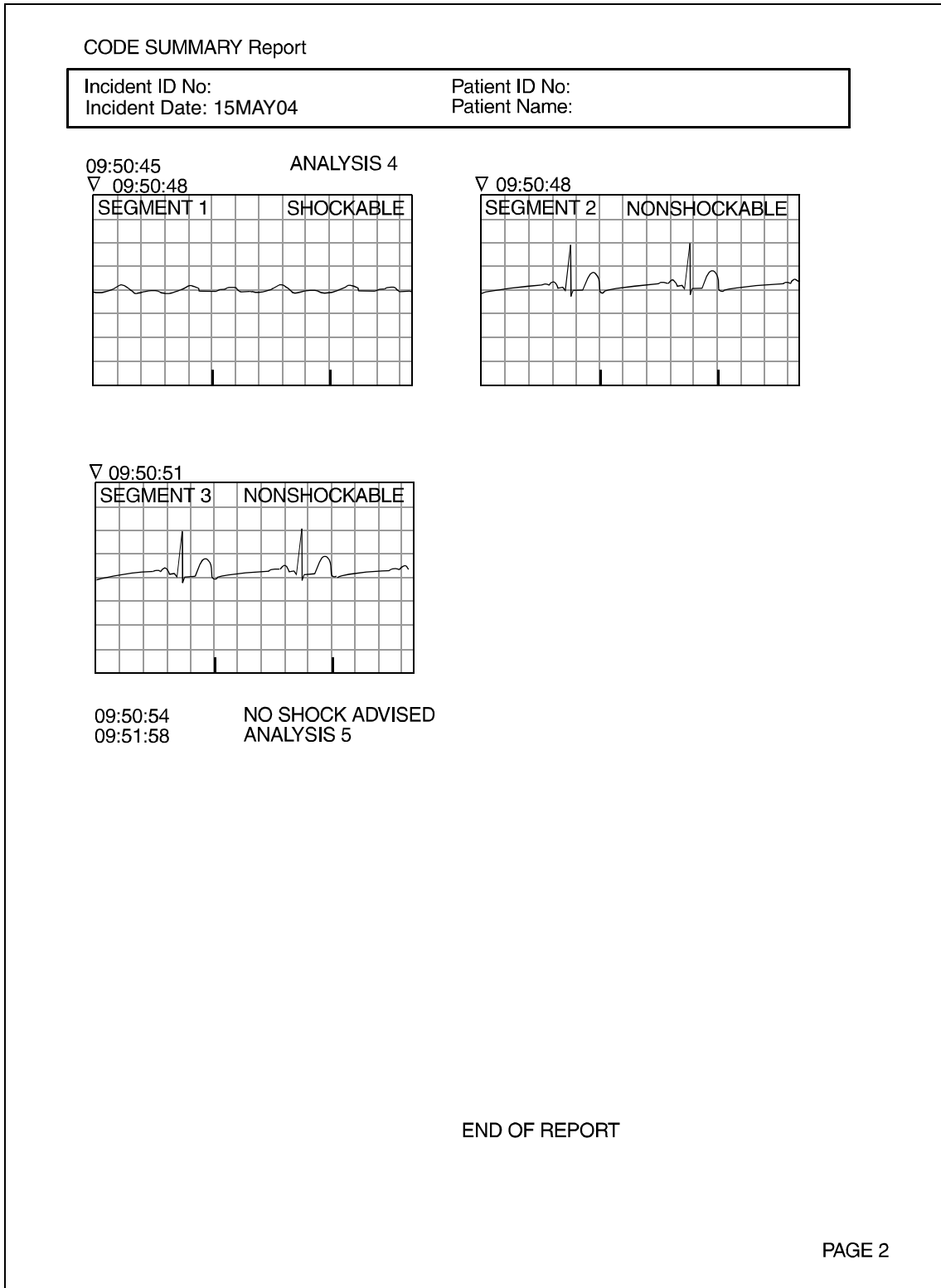

Figure 4-10 Example of CODE SUMMARY Report (cont.)

Test Log Report

Device Type: LIFEPAK 500  
Device Serial No: 00001203  
Device ID: RFD#6

Software REV: 3005360-000 REV .4.4  
Configuration: 000000000

Test History Log:

28 APR 04 03:00:12	SELF TEST:	PASS
28 APR 04 08:30:41	SELF TEST:	PASS
29 APR 04 03:00:09	SELF TEST:	PASS
03 APR 04 03:00:09	SELF TEST:	PASS
01 MAY 04 03:00:09	SELF TEST:	PASS
02 MAY 04 03:00:09	SELF TEST:	PASS
03 MAY 04 03:00:09	SELF TEST:	PASS
04 MAY 04 03:00:09	SELF TEST:	PASS
05 MAY 04 03:00:09	SELF TEST:	PASS
05 MAY 04 08:27:10	SELF TEST:	PASS
06 MAY 04 03:01:40	SELF TEST:	PASS
07 MAY 04 03:00:09	SELF TEST:	PASS
08 MAY 04 03:00:09	SELF TEST:	PASS
09 MAY 04 03:00:09	SELF TEST:	PASS
10 MAY 04 03:00:09	SELF TEST:	PASS
11 MAY 04 03:00:09	SELF TEST:	PASS
12 MAY 04 03:00:09	SELF TEST:	PASS
12 MAY 04 08:30:42	SELF TEST:	PASS
13 MAY 04 03:00:09	SELF TEST:	PASS
14 MAY 04 03:00:09	SELF TEST:	PASS
15 MAY 04 03:00:09	SELF TEST:	PASS
16 MAY 04 03:00:09	SELF TEST:	PASS
17 MAY 04 03:00:09	SELF TEST:	PASS
18 MAY 04 03:00:09	SELF TEST:	PASS
19 MAY 04 03:00:09	SELF TEST:	PASS
19 MAY 04 08:30:40	SELF TEST:	PASS
20 MAY 04 03:00:09	SELF TEST:	PASS
21 MAY 04 03:00:09	SELF TEST:	PASS
22 MAY 04 03:00:09	SELF TEST:	PASS
23 MAY 04 03:00:09	SELF TEST:	PASS

Major Fault Log:  
No entries found

Minor Fault Log:  
No entries found

END OF REPORT

PAGE 1

Figure 4-11 Test Log Report Example

## MAINTENANCE

This section describes how to perform operator-level maintenance and testing on the LIFEPAK 500 Automated External Defibrillator (AED). For troubleshooting information, refer to page 6-2. Topics in this section include:

Maintenance and Testing Scheduling	page 5-2
Inspection	5-2
Cleaning	5-4
Testing	5-4
Battery Maintenance	5-7
Electrode Storage	5-13
Service and Repair	5-13
Warranty	5-14
Supplies, Accessories, and Training Tools	5-14
Specifications	5-15
Clinical Summary: Defibrillation of Ventricular Fibrillation and Ventricular Tachycardia	5-21

**MAINTENANCE AND TESTING SCHEDULING**

The LIFEPAK 500 AED performs an automatic self-test every 24 hours. If the automatic self-test detects a low battery condition or a condition that requires service, the monophasic AED activates an alarm; AEDs with a readiness display will change the indicators on the display and will not activate an alarm unless **AUDIO ALERT** is configured **ON**. It is important to place the AED where the alarm is likely to be heard, to periodically inspect the AED, and to check display indicators (refer to the following inspection subsection).

The AED also performs a self-test every time you turn on the AED. These self-tests do not eliminate the need for regular maintenance. You should do the following on a regular basis and after each time the AED is used:

- Inspect the AED as described in Table 5-1.
- Clean the AED as described in Table 5-2.
- Check to make sure that all necessary supplies and accessories (such as properly-maintained batteries and therapy electrodes) are readily accessible.

Your local operator maintenance schedule should consider how familiar the operators are with AED operation, how often the AED is used, and the age of the AED batteries. If AED batteries are two years old or older, weekly inspection is recommended. If AED batteries are less than two years old, consider the following:

- If the AED is used on a weekly basis, daily inspections may be appropriate.
- If the AED is used on a monthly basis, weekly inspections may be appropriate.
- If the AED is used very infrequently, such as once a year, monthly inspections may be appropriate.

**INSPECTION**

Routinely inspect all devices, accessories, and cables by following the instructions in Table 5-1.

Table 5-1 LIFEPAK 500 AED Inspection

Instruction	Inspect for	Recommended Corrective Action
Examine the AED case, connector, battery well, battery pins, and accessories.	Foreign substances.	Clean the device as described in Table 5-2.
	Damage or cracks.	Contact authorized service personnel to troubleshoot and repair parts.
	Battery pins bent or discolored.	Contact authorized service personnel to replace or repair parts.
	Expired batteries or defibrillation electrodes.	Replace.



Table 5-1 LIFEPAK 500 AED Inspection (Continued)

Instruction	Inspect for	Recommended Corrective Action
AEDs with readiness display: Observe readiness display	<b>OK</b>	None needed.
	Battery indicator displayed	Replace battery immediately.
	Service indicator displayed	Contact authorized service personnel to replace or repair parts.
AEDs without a readiness display: With the battery installed, press <b>ON/OFF</b> to turn on the AED.	<b>BATTERY OK</b> <b>SELF-TEST xx.xx</b> message.	None needed.
	Illumination and display of each LED, all indicators, and all LCD segments.	Contact authorized service personnel to repair or replace parts.
	<b>BATTERY LOW</b> or <b>REPLACE BATTERY SELF-TEST xx.xx</b> message.	Replace the battery immediately.
	Service indicator or <b>CALL SERVICE</b> message.	 Contact authorized service personnel to troubleshoot and repair the device.
Examine accessory cables.	Foreign substances.	Clean the cables as described in Table 5-2.
	Bend and flex the cable and inspect for cracks, damage, extreme wear, broken or bent connectors and pins.	Replace damaged or broken parts.
	Confirm that connectors engage securely.	Replace damaged or broken parts.

**CLEANING**

Clean the LIFEPAK 500 AED and accessories as described in Table 5-2. Use only the cleaning agents listed in the table.

**CAUTION!**

**Possible equipment damage.**

Do not clean any part of the AED or accessories with bleach, bleach dilution, or phenolic compounds. Do not use abrasive or flammable cleaning agents. Do not steam, autoclave, or gas-sterilize the LIFEPAK 500 AED or accessories.

Table 5-2 Recommended Cleaning Methods

Items	Cleaning Practice	Recommended Cleaning Agent
LIFEPAK 500 AED case, display, crevices, and accessories	Clean with damp sponge or cloth.	<ul style="list-style-type: none"> <li>• Quaternary ammonium compounds</li> <li>• Rubbing (isopropyl) alcohol</li> <li>• Peroxide (peracetic acid) solutions</li> </ul>

**TESTING**

This section describes the AED automatic self-tests and the test load test. If testing indicates a problem, refer to Troubleshooting on page 6-2. If you cannot correct the problem, remove the AED from active service and contact authorized service personnel.

The AED stores the results of auto tests and the external test load test in a test log. For information about retrieving test log data, refer to page 4-4.

**Service Indicator and Message**

The service indicator appears if the automatic self-test detects a problem that requires service.

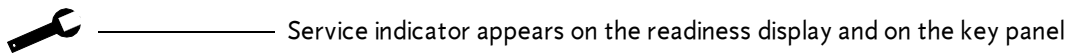

If the service indicator appears on the key panel (but not flashing), you can still use the AED if it is needed for patient therapy. However, you should contact authorized service personnel to correct the problem as soon as possible. The service indicator will display until the problem is corrected.

If the automatic self-test detects a problem that requires immediate service (such as a malfunctioning charging circuit), the service indicator appears on the readiness display, the service indicator on the key panel flashes, and the **CALL SERVICE** message appears.



Readiness Display on Device Handle



Display on Key Panel

Turn the AED off and on. If the **CALL SERVICE** message disappears, you can still use the AED if it is needed for patient therapy. However, you should contact authorized service personnel to correct the problem as soon as possible. If the **CALL SERVICE** message reappears, the service indicator on the device key panel will continue to flash and the message will remain on. Contact authorized service personnel immediately to correct the problem. You should not use the AED until the problem is corrected.

### Power-On Self-Test

Whenever the AED is turned off for at least 60 seconds and then turned on, the AED performs a “cold start.” During a cold start, the AED performs internal self-tests to check that internal electrical components and circuits work properly. During the self-test, the AED displays the following messages:

MEDTRONIC  
XXXX-XXXX

The xs indicate the software version installed.

BATTERY OK  
SELF-TEST xx.xx

If the AED requires service, the service indicator appears. Contact authorized service personnel to perform service.

**Note:** If the battery has an adequate charge to deliver therapy, you will see **OK** on the readiness display and the **BATTERY OK** message on the LCD during the self-test. If the battery is low, you will see a battery indicator on the readiness display, an illuminated battery indicator on the device key panel, and the **LOW BATTERY** message on the LCD. When the **LOW BATTERY** message first appears, the device will provide eleven or more shocks for a nonrechargeable battery and six or more shocks for a rechargeable battery. If the battery is very low, the **REPLACE BATTERY** message displays and the battery indicator on the key panel flashes. When the **REPLACE BATTERY** message first appears, the device will provide three or more shocks.

### Auto Tests

The AED periodically performs auto tests. During an auto test, the AED displays the following message:

BATTERY OK  
SELF-TEST xx.xx

If the AED detects a problem during an auto test that requires service but does not prevent AED use, it displays the service indicator the next time you turn on the AED.

If the AED (monophasic AEDs only) detects a problem during an auto test that requires immediate service, it activates an intermittent, audible alarm.

**Note:** It is important that when the AED is stored with the battery installed, temperature exposure should not fall below 0°C (32°F) or exceed 50°C (122°F). If the AED is stored outside this temperature range, the auto tests may erroneously detect a problem and the AED may not operate properly.

### Daily Auto Test

Every day at 0300 (3:00 am) the AED automatically performs the following tasks:

- Turns itself on (the **ON/OFF** LED illuminates briefly).
- Performs self-test (**SELF-TEST** message displays).
- Stores the results in the Test Log.
- Turns itself off.

On a regular basis, the Daily Auto Test will test for low or replace battery conditions.

The Daily Auto Test is not performed if the AED is already turned on at 0300 or if the battery is not installed. If the AED is turned on while the Daily Auto Test is in progress, the test is halted; the AED will turn on normally.

### **Extended Auto Test**

The AED automatically turns on and performs the Extended Auto Test on a regular basis at 0300. In the Extended Auto Test, the AED performs the following tasks:

- Turns itself on (the **ON/OFF** LED illuminates briefly).
- Performs Extended Self-test (**SELF-TEST** message displays).
- Stores the results in the Test Log.
- Turns itself off.

To use the AED when the Extended Auto Test is in progress, push **ON** or connect the electrodes to the patient. The test will be halted and the AED will operate normally. The Extended Auto Test is not performed if the AED is already turned on at 0300 or if the battery is not installed.

### **External Test Load Test**

The external test load test checks the AED charging circuits and the operator's response during a typical ECG analysis and charging cycle. During this test, the AED charges for a low energy test shock. The usual messages and audio prompts are provided.

To perform the test load test:

- 1 Make sure that the AED is turned off.
- 2 Connect the test load to the cable connector receptacle on the AED.

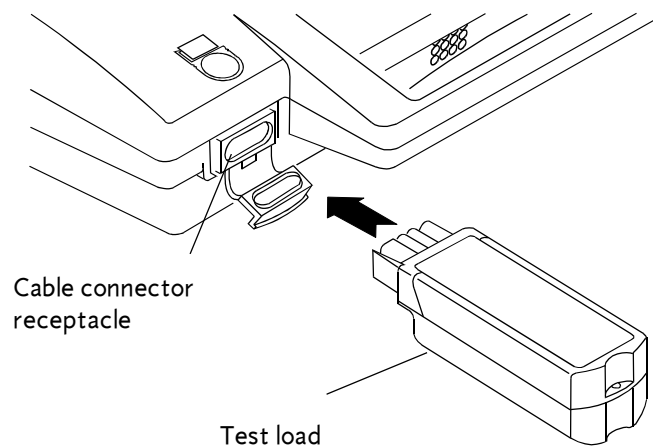

Figure 5-1 Test load connection

- 3 Press **ON/OFF** and observe that the **TEST MODE** message appears. (The **TEST MODE** message is displayed throughout the test.) If the **TEST MODE** message does not display, reconnect the test load and try again. If **AUTO ANALYZE** is off or **AUTO ANALYZE 1** is selected, you will see and hear:

**PUSH ANALYZE** message

**PUSH ANALYZE** voice prompt

- 4 Press **ANALYZE**. If **AUTO ANALYZE 2** is selected or you have an AED that does not have an **ANALYZE** button, the AED will start analyzing automatically.

You will see and hear:

**ANALYZING NOW** and **STAND CLEAR** messages

*ANALYZING NOW, STAND CLEAR* voice prompts

After a few seconds you will see and hear:

**SHOCK ADVISED** message

*SHOCK ADVISED* voice prompt

A rising charging tone that simulates a typical charge time

- 5 When the AED is fully charged, you will see and hear:

**STAND CLEAR** and **PUSH TO SHOCK** messages

*STAND CLEAR* and *PUSH TO SHOCK* voice prompts

- 6 Press **SHOCK** to discharge the energy into the test load.

- 7 Confirm that the AED displays the **TEST OK** message.

- 8 Disconnect the test load.

- 9 Press **ON/OFF** to turn off the AED.

- 10 Prepare the AED for the next patient use.

After the test is complete, the AED records the results in the Test Log. If the AED detects a problem during the test, the service indicator and **CALL SERVICE** message appear. Contact authorized service personnel to perform service. To repeat the test, turn off the AED and then turn it on again.

## BATTERY MAINTENANCE

The LIFEPAK 500 AED can be powered by two types of batteries:

- LIFEPAK 500 nonrechargeable lithium sulfur dioxide (LiSO<sub>2</sub>) or lithium manganese dioxide (LiMnO<sub>2</sub>) battery pak
- LIFEPAK 500 rechargeable sealed lead-acid (SLA) battery pak

**Note:** Unless stated otherwise, references to nonrechargeable lithium batteries apply to both LiSO<sub>2</sub> and LiMnO<sub>2</sub> battery technologies.

Either type of battery may be installed. Follow the guidelines described in this section to help maximize battery life and performance. Use only Medtronic Battery Pak batteries with the LIFEPAK 500 AED.

### WARNINGS!

#### Inability to provide therapy.

The LIFEPAK 500 nonrechargeable lithium manganese dioxide battery pak does not fit in all LIFEPAK 500 AEDs. Use only with AEDs marked -003 inside the battery well.

#### Possible AED shutdown.

When the LIFEPAK 500 AED prompts **REPLACE BATTERY**, replace the battery immediately.

#### Possible loss of power during patient care.

Using an improperly maintained battery to power the AED may cause power failure without warning. Maintain batteries as described in these Operating Instructions.

**Note:** When a battery pak is removed from the AED, battery and service indicators appear on the readiness display. After replacing the battery pak, turn on the device to reset the readiness display.

### Nonrechargeable Battery Pak

The nonrechargeable lithium battery pak requires less maintenance than the rechargeable SLA battery pak since it never requires recharging. With the lithium battery pak installed, the LIFEPAK 500 AED automatically tests it as part of the Daily Auto Test. The AED also performs the battery test during each charge/discharge cycle and the first time the AED is turned on after a new battery has been installed.

To check the battery level, turn on the AED for at least 10 seconds and look for the **BATTERY** status message during the self-test. If there is no message, turn off the AED for at least one minute and then turn it on again. The battery status message should appear following the self-test. Do not check the status of more than two lithium batteries within a 15-minute period. The AED may not accommodate more frequent battery checks.

When optimally maintained, a new LiSO<sub>2</sub> battery pak has a capacity of 7.5 Amp hours, which is equivalent to 14 hours of "on time" or 312 discharges. A new LiMnO<sub>2</sub> battery pak has a capacity of 10.0 Amp hours, which is equivalent to 18 hours of "on time" or 416 discharges. Just turning the AED on ("on time") uses up battery capacity.

Each year, battery capacity decreases while the battery is in the AED because of the battery's normal self-discharge rate and the energy used by the AED auto tests. After four years with no patient use of the AED, approximately 35% of the useful life of the LiSO<sub>2</sub> battery remains and approximately 50% of the useful life of the LiMnO<sub>2</sub> battery remains (LiSO<sub>2</sub>: 4.9 hours of "on time" or 109 discharges and LiMnO<sub>2</sub>: 8.9 hours of "on time" or 208 discharges). Any patient use of the AED, "on time" and shocks, will reduce the battery's useful life further.

The life expectancy of an LiSO<sub>2</sub> battery pak can be described in terms of the battery pak's shelf life and active life. Shelf life is the length of time the battery pak can be stored separately from the AED before its capacity is depleted. An unused LiSO<sub>2</sub> battery pak has a five-year advertised shelf life. If an LiSO<sub>2</sub> battery pak is stored in an environment with temperatures ranging between 15°–35°C (59°–95°F), it will have some, but limited, battery capacity remaining at the end of five years. However, after the five year date, we recommend that the battery be discarded and not used.

Active life is the battery capacity when the battery pak is installed in an AED. The active life of an LiSO<sub>2</sub> will **not** be the same as its shelf life. Active life can range from 12 months to four years. The length of time is determined by several factors, such as:

- AED Usage (patient use and operator-initiated testing)
- AED Storage Environment (temperature)
- AED Automatic Self-tests

Figures 5-2 through 5-4 illustrate the effect of these factors with three different usage levels.

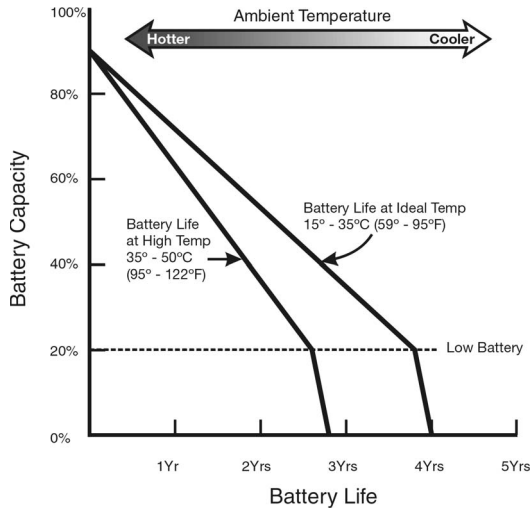

Figure 5-2 Active life, no patient use

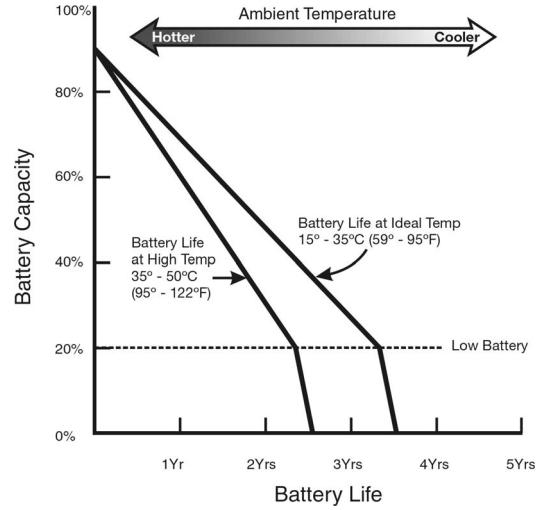

Figure 5-3 Active life, one patient use per year

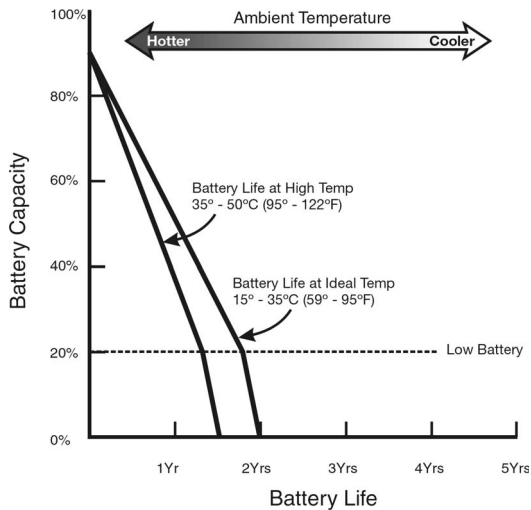

Figure 5-4 Active life, patient use every two months

The time for any particular battery to transition from a low battery to a battery depleted state varies greatly and is unpredictable due to differences in battery usage conditions. The transition time from low battery to battery depleted may be as short as 2 days. As a result, we recommend that you increase the frequency of your AED inspections, the longer a battery has been in an AED, in particular after two years. It is recommended to replace LiSO<sub>2</sub> batteries that have been installed in an AED for two years or more, regardless of usage.

To properly maintain nonrechargeable lithium battery paks:

- Do not attempt to recharge (lithium battery paks cannot be connected to the battery charger used to recharge the rechargeable SLA battery paks).
- Do not use beyond the expiration date marked on the battery label.
- Do not expose to temperatures greater than 50°C (122°F).
- Do not allow electrical connection between the battery contacts.
- Store individual battery paks and AEDs with batteries installed in an environment with temperatures between 15° and 35°C (59° and 95°F). Higher temperatures accelerate the loss of charge.

### WARNING!

**Possible explosion, fire, or noxious gas.**

Attempting to recharge a LIFEPAK 500 nonrechargeable lithium battery pak can cause an explosion or fire or release noxious gas. Dispose of expired or depleted lithium battery paks as described in these operating instructions.

### CAUTION!

**Possible battery damage.**

Electrical connection between battery contacts can blow an internal fuse and permanently disable the battery.

### Discharging Nonrechargeable Batteries

Before disposing of lithium battery paks, make sure that they are fully discharged. To discharge a lithium battery pak, follow this procedure:

- 1 Place the battery pak with the label side up on a firm, flat surface such as a table top or floor.
- 2 Locate the small slot on the corner marked by the arrow:

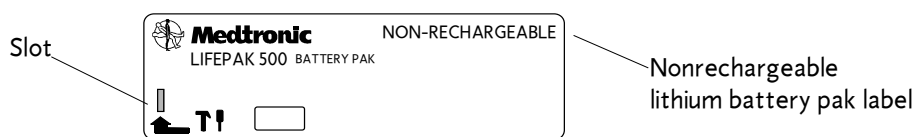

- 3 Place the tip of a flat-tipped screwdriver on the slot.
- 4 Using a hammer, strike a moderate blow straight down on the top of the screwdriver handle. Make sure that the tip of the screwdriver breaks the label and penetrates approximately 3 mm (1/8 inch). This will strike an internal pin, initiate full discharge, and permanently disable the battery.
- 5 Set the battery pak aside. Wait for at least 1 week to make sure that the battery pak is fully discharged before disposing.

### Disposing of Nonrechargeable Batteries

After fully discharging a lithium battery pak as described previously, dispose of the battery pak. Follow your national, regional, and local regulations for disposal. Contact a local Medtronic representative for more information.



In the USA, Environmental Protection Agency and Department of Transportation regulations allow disposal of lithium batteries with ordinary household waste **provided that they are fully discharged**. Be sure to comply with any other local or regional regulations before disposal. For more information or assistance, contact your local Medtronic representative or call 1.800.442.1142.

## Rechargeable Battery Pak

The rechargeable SLA battery pak requires more maintenance than a lithium battery pak since it must be recharged periodically. The SLA battery pak should be recharged monthly or after each use. SLA battery paks are most appropriate when the LIFEPAK 500 AED is used on a frequent basis and for those who use the AED with a simulator for training. With an SLA battery pak installed, the LIFEPAK 500 AED automatically turns on to test it as part of the Extended Auto Test. To check the battery level, turn on the AED and look for the **BATTERY OK** message during the self-test. Do not check the status of more than 3 SLA batteries within a 15-minute period.

When optimally maintained, a new SLA battery pak can provide approximately 3 hours of "on time" or 59 discharges during 3 months of use without recharging the battery. Just turning the AED on ("on time") uses up battery capacity. Each month, battery capacity decreases while the battery is in the AED because of the battery's normal self-discharge rate and the energy used by the AED self-tests. Figure 5-5 shows the expected capacity of the SLA battery pak without recharging over 3 months as a result of AED self-tests and battery self-discharge only. For example, after one month with no patient use of the AED, approximately 20% of the useful life of the battery has been depleted. Any patient use of the AED ("on time" and shocks) will reduce the capacity further. Even when properly maintained, SLA battery paks should be replaced every two years or after 200 charge cycles, whichever comes first.

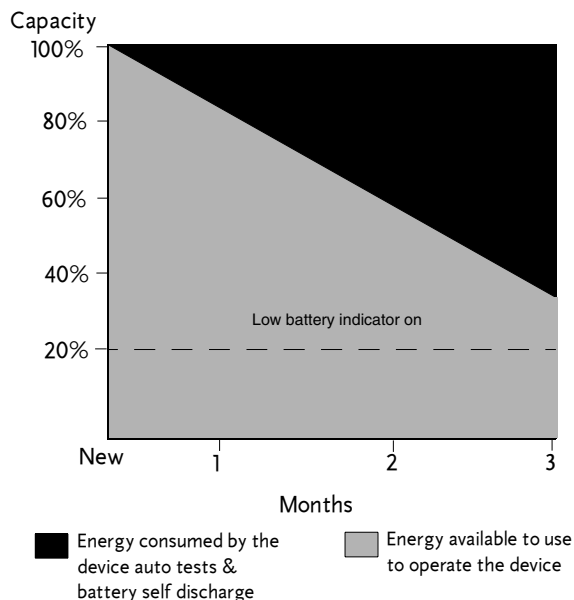

Figure 5-5 SLA battery capacity while installed in an AED for 3 months at 20°C (68°F) without recharging

To properly maintain SLA battery paks:

- Recharge after each use or once a month, whichever comes first. Maintain a battery recharge record.
- Use only the Medtronic battery charger designed for use with the LIFEPAK 500 AED. Do not use any other charger.

- Recharge until the battery charger charge LED is green. This indicates that the battery charger has completed the fast-charge cycle. Undercharging can cause battery damage.
- Recharge only at temperatures between 15° and 35°C (59° and 95°F).
- Never expose battery paks to temperatures greater than 50°C (122°F).
- Battery paks are best when used and stored between 0° and 35°C (32° and 95°F). Higher temperatures accelerate the loss of charge and wear out the battery pak sooner. Lower temperatures reduce battery capacity.
- Do not allow electrical connection between the battery contacts.

### WARNINGS!

#### Possible loss of power during patient care.

Stored batteries lose charge. Failure to charge a rechargeable battery before use may cause device power failure without warning. Always charge a stored battery before placing it in active use.

#### Possible loss of power during patient care.

Using an improperly maintained battery to power the defibrillator may cause power failure without warning. Use the LIFEPAK 500 battery charger to charge the rechargeable battery pak.

### CAUTIONS!

#### Possible battery damage.

Recharge the battery until the battery charger charge LED is green. Undercharging can cause battery damage.

#### Possible battery damage.

Charging batteries outside the temperature range of 15°–35°C (59°–95°F) may cause improper charging and shorten battery life.



#### Possible battery damage.

Electrical connection between battery contacts can blow an internal fuse and permanently disable the battery.

### Recharging a Rechargeable Battery Pak

The battery charger fully charges a connected SLA battery in about 10 hours. The battery charger applies a high-level, fast charge for the first 10 hours that the battery is connected. If the battery remains connected, the battery charger applies a low-level trickle-charge to maintain a full charge. Agency approval markings are provided on the bottom of the battery charger.

To charge a battery:

- 1 Connect the battery charger to an appropriate ac power source (100 to 240Vac, 50 or 60 Hz). The green LED (marked by the  symbol) appears when the power is connected.
- 2 Connect the battery to the battery charger.
- 3 Confirm that the charge LED (marked by the  symbol) is amber. This indicates that the battery charger is applying a fast charge.
- 4 Wait at least 10 hours. Then, confirm that the charge LED is green. The green LED indicates that the fast-charge cycle is complete and the battery is receiving a trickle-charge to maintain full charge.
- 5 Disconnect the battery.

A fully charged battery is not harmed if it remains connected to the battery charger. However, if a battery is disconnected and then reconnected, the battery charger begins the 10 hours of fast charge again. Additional battery charge cycles without discharging can reduce battery life.

### Recycling Rechargeable Batteries

Recycle SLA battery paks locally according to national, regional, and local governmental regulations. If recycling is not possible, contact a Medtronic representative for information or assistance. In the USA, call 1.800.442.1142.

To promote awareness of battery recycling, SLA battery paks are marked with this label:



---

## ELECTRODE STORAGE

For information about defibrillation electrode storage, refer to the operating instructions for the FAST-PATCH and QUIK-COMBO electrodes.

---

## SERVICE AND REPAIR

### WARNING!

#### Shock hazard.

Do not disassemble the defibrillator. It contains no operator serviceable components and dangerous high voltages may be present. Contact authorized service personnel for repair.

If the LIFEPAK 500 AED requires service as indicated by testing, troubleshooting, or the service indicator, contact authorized service personnel. In the USA, call Medtronic Technical Support at 1.800.442.1142. When you call Medtronic to request service, provide the following information:

- Model number and part number
- Serial number
- Observation of the problem that led to the call

If the device must be shipped to a service center or the factory, pack the device in the original shipping container. If this is not possible, ship the device in protective packing to prevent shipping damage.

The *LIFEPAK 500 AED Service Manual* provides detailed technical information to support service and repair by authorized service personnel.

### Product Recycling Information

Recycle the device at the end of its useful life.

- **Recycling Assistance**

The device should be recycled according to national and local regulations. Contact your local Medtronic representative for assistance.

## Maintenance

- **Preparation**

The device should be clean and contaminant-free prior to being recycled.

- **Recycling of Disposable Electrodes**

After disposable electrodes are used, follow your local clinical procedures for recycling.

- **Packaging**

Packaging should be recycled according to national and local regulations.

---

## WARRANTY

Refer to the product warranty statement included in the accessory kit shipped with the product. For duplicate copies, contact your local Medtronic representative. In the USA, call 1.800.442.1142.

---

## SUPPLIES, ACCESSORIES, AND TRAINING TOOLS

Table 5-3 lists supplies, accessories, and training tools for the LIFEPAK 500 AED. For information about ordering, contact your local Medtronic representative. In the USA, call 1.800.442.1142.

Table 5-3 Supplies, Accessories, and Training Tools

Description	Part Number
LIFEPAK 500 nonrechargeable lithium sulfur dioxide battery pak, yellow	3005380-026
LIFEPAK 500 nonrechargeable lithium sulfur dioxide battery pak, yellow, (FAA TSO-C97 aircraft certified)	3005380-027
LIFEPAK 500 nonrechargeable lithium sulfur dioxide battery pak, yellow, (CAA BS2BS2G9 aircraft certified)	3005380-028
LIFEPAK 500 nonrechargeable lithium sulfur dioxide battery pak, dark gray	3005380-042
LIFEPAK 500 nonrechargeable lithium manganese dioxide battery pak, yellow	3200390
LIFEPAK 500 nonrechargeable lithium manganese dioxide battery pak, yellow (FAA TSO-C142 aircraft certified)	3201856
LIFEPAK 500 rechargeable SLA battery pak	3005379
QUIK-COMBO pacing/defibrillation/ECG electrodes with REDI-PAK preconnect system	3008497
QUIK-COMBO pacing/defibrillation/ECG electrodes (.6 m [2 ft] lead wire)	3010188-011
QUIK-COMBO defibrillation cable (not compatible with Infant/Child electrodes)	3011215
Infant/Child Reduced Energy Defibrillation Electrodes (not compatible with the QUIK-COMBO defibrillation cable, monophasic LIFEPAK 500 AED, or biphasic LIFEPAK 500 AEDs without the pink connector)	3202380
LIFEPAK 500 battery charger	3011200
Medtronic Test Load	3005389
QUIK-COMBO Patient Simulator	803499-09
FAST-PATCH defibrillation cable kit	3010699
FAST-PATCH disposable defibrillation/ECG electrodes	3010188-013
Medtronic Patient Simulator (English) (For use with FAST-PATCH defibrillation cable.)	803499-08

Table 5-3 Supplies, Accessories, and Training Tools (Continued)

Description	Part Number
CODE-STAT Suite data management system	3011520
Data Transfer 500 information management program	3005332
LIFEPAK 500 Carrying Case (soft)	3005343
LIFEPAK 500 Carrying Case (hard)	3005384
LIFEPAK 500 Electrode Storage Tray kit	3010697
AED Instruction Card	3011111
LIFEPAK AED TRAINER	3012714
AED TRAINER training electrodes	3006007
Wall mount bracket	3009767
Spare battery pouch kit	3010698
<b>Cables:</b>	
LIFEPAK 500 Printer Cable	3005381-002
LIFEPAK 500 Modem Cable	3005381-001
LIFEPAK 500 PC Cable	3005381-000
Setup Transfer Cable	3010779
<b>Literature:</b>	
<i>LIFEPAK 500 AED Operating Instructions</i>	3005338
<i>LIFEPAK 500 AED Setup Instructions</i>	3012275
<i>Therapy Electrodes Operating Instructions</i>	3200346
<i>LIFEPAK 500 AED Service Manual</i>	3005339
<i>Defibrillation: What You Should Know</i>	805662
<i>Training and Implementation Guide for use with the LIFEPAK 500 automated external defibrillator</i>	3011020
<i>AED Challenge Interactive Computer Training Tool</i>	3011019-000

## SPECIFICATIONS

Table 5-4 lists the specifications for the monophasic, biphasic, and public safety (DPS) LIFEPAK 500 AEDs. The specifications apply to all LIFEPAK 500 AEDs unless otherwise noted.

Table 5-5 lists the specifications for the LIFEPAK 500 AED Battery Charger

Table 5-4 LIFEPAK 500 AED Specifications <sup>1</sup>

AED	
Input	ECG via QUIK-COMBO or FAST-PATCH disposable electrodes. Standard placement: anterior-lateral. Alternate placement: anterior-posterior.
Electrical Protection	Input protected against high voltage defibrillator pulses per IEC 60601/EN 60601.

<sup>1</sup> All specifications at 20°C (68°F) unless otherwise stated. All performance specifications assume the device has been stored (two hours minimum) at the operating temperature prior to operation.

Safety Classification	Internally powered equipment IEC 60601-1/EN 60601-1, 5.1.
Waveform	Monophasic: Monophasic pulse (Edmark) per AAMI DF2-1989, 3.2.1.5.1 Biphasic and DPS: truncated exponential, with voltage and duration compensation for patient impedance. <sup>2</sup>
Output Energy Accuracy	±15% into 50 ohms (monophasic) ±10% into 50 ohms (biphasic) ±15% into 25 to 100 ohms (biphasic)
Output Energy Sequence	Monophasic: 200, 200, 360 joules (360 joules thereafter) or 200, 300, 360 joules (360 joules thereafter). Biphasic and DPS: Three levels, user configurable from 200 to 360 joules, delivered (Level 1, Level 2, Level 3, Level 3...).
Charge Time	With a new, nonrechargeable battery pak, or a new, fully charged rechargeable battery pak: 200 joules in less than 9 seconds. 360 joules in less than 15 seconds.
Controls	
<b>ON/OFF</b>	Turns device power on or off.
<b>ANALYZE</b>	Starts ECG analysis. (Optional).
<b>SHOCK</b>	Delivers defibrillation energy. Active only when Shock Advisory System advises defibrillation.
Clock Set	Two switches ▲ and ► are provided to set the clock.
Display	Two-line, 20-character per line dot matrix liquid crystal display.
Readiness Display	Biphasic and DPS: Indicates <b>OK</b> when self-test completed successfully.
Low Battery Indicator	Low battery icon: At least 11 discharges remaining with nonrechargeable battery pak. At least 6 discharges remaining with rechargeable battery pak.
Service Indicator	Service icon.
Displayed Messages	Messages prompt user through complete operating sequence.
Audible Tones	Coded tones assist user through device operation and alert operator of display messages.
Voice Prompts	Prompt user through complete operation sequence.
Color	Monophasic and biphasic: Yellow. DPS: Dark Gray.

<sup>2</sup> Specifications apply from 25 to 200 ohms. Voltage compensation is limited to the voltage that would result in delivery of 360 joules into 50 ohms.

## EVENT DOCUMENTATION

Type	Internal digital memory.
Memory Capacity	20 minutes audio recording (optional). ECG and event log of operator/device actions: <ul style="list-style-type: none"> <li>– At least 20 minutes if unit is configured with audio recording and audio recording setup option is <b>ON</b>.</li> <li>– At least 80 minutes if configured with audio recording and audio recording setup option is <b>OFF</b>.</li> <li>– At least 60 minutes if not configured with audio recording.</li> </ul>
Report Types	CODE SUMMARY report, Event Log report, Test Log report.
Capacity	300 Event Log events. 30 Test Log device tests (assuming no fault codes).
Communications	Options: <ul style="list-style-type: none"> <li>– Direct connection to personal computer</li> <li>– Modem connection to personal computer using Hayes AT-Compatible modem.</li> <li>– Print direct with EPSON® ESC/P protocol for printers with 9-pin printheads.</li> </ul>
Data Review	LIFENET™ system compatible. Options: <ul style="list-style-type: none"> <li>– DATA TRANSFER™ 500 information management program</li> <li>– QUIK-VIEW™ 500 data review program</li> <li>– CODE-STAT™ Suite data management system, v 2.0 or above.</li> </ul>

## ENVIRONMENTAL

Operating Temperature	0°–50°C* (32°–122°F).
Storage Temperature	-30°–65°C* (-22°–149°F) without battery and electrodes. -30°–65°C* (-22°–149°F) with battery and electrodes, maximum total exposure time limited to one week.
Atmospheric Pressure	Monophasic and biphasic: MIL-STD-810E 760 to 429 mmHg (0 to 15,000 ft above sea level). DPS: MIL-STD-810E, Method 500.3, Procedure II (Operation): -609.6m to 4,572m (-2000 ft to 15,000 ft).
Relative Humidity	10 to 95% (non-condensing).
Dust/Water Resistance	Monophasic and biphasic: IEC 60529/EN 60529 IPX4 (Splash-proof) with electrodes or connector cover installed. DPS: IEC 60529/EN 60529 IP54 (Dust/Splash-proof) with electrodes or connector cover installed.
Shock	MIL-STD-810E, Method 516.4, Procedure 1 (40 g, 6–9 ms pulse, 1/2 sine each axis).

\* **Note:** See page 5-7 for information on caring for batteries.

Vibration	<p>Monophasic: MIL-STD-810E, Method 514.4, Category 10</p> <p>Biphasic: MIL-STD-810E, Method 514.4, Helicopter- Category 6 (3.75 G<sub>RMS</sub>) and Ground Mobile - Category 8 (3.15 G<sub>RMS</sub>). RTCA/DO-160C, Table 8-2 Fixed Wing - Turbojet Engine Classification C' (Fuselage). Test level per Figure 8-5 C. 1 hour in each of three axes.</p> <p>DPS: MIL-STD-810F, Method 514.5, Helicopter</p> <p>Operational: Sine/Random (1.58 G<sub>RMS</sub>) 1 hour per axis</p> <p>Storage: Sine/Random (3.10 G<sub>RMS</sub>) 1 hour per axis</p> <p>Jet Aircraft Random (3.54 G<sub>RMS</sub>), 30 min. per axis</p> <p>Turboprop Random (4.87 G<sub>RMS</sub>), 1 hour per axis</p>
Aircraft	RTCA/DO-160D (Environmental Conditions and Test Procedures for Airborne Equipment), Section 21, Category M, (Radiated Emissions).
ESD	Electrostatic Discharge: Exceeds EN60601-1-2 (8kV contact, 15kV air)
Salt Fog	DPS: MIL-STD-810E, Method 509.3
HALT	DPS: Highly Accelerated Life Test (HALT), random vibration/temperature step stress, 6 degrees of freedom up to 46 G <sub>RMS</sub> and -70°C to 110°C (-158°F to 230°F) at PCB level.

**GENERAL**

**Rechargeable SLA battery pak**

Type	Sealed lead-acid, 8V, 2.5 amp hours.
Capacity	<p>Typical: 59 full discharges or 3 hours of "on time" at 20°C (68°F) with a new, fully charged battery.</p> <p>Minimum: 43 full discharges with a new, fully charged battery.</p>
Battery Charge Time	10 ±1 hours. Battery charging limited to 15°–35°C (59°–95°F).
Recommended Replacement Interval	Two years or 200 battery charge/discharge cycles, whichever comes first using recommended battery maintenance procedures.
Weight	0.9 kg (1.9 lb).

**Nonrechargeable battery pak**

**Lithium sulfur dioxide (LiSO<sub>2</sub>) battery**

Type	Sealed lithium, 12V, 7.5 amp-hours.
Certification	<p>FAA: TSO-C97 (Battery 3005380-027)</p> <p>CAA: BS2G239 (Battery 3005380-028)</p>



Capacity Typical: 312 full discharges or 14 hours of "on time" with a new battery.  
 Minimum: 230 full discharges with a new battery at 20°C.  
 0°–58°C (32°–136°F) is a minimum of 197 full discharges with a new battery.

Shelf Life Five years  
 Four years (TSO-C97 for aircraft use)

Weight 0.5 kg (1.2 lb)

Lithium manganese dioxide (LiMnO<sub>2</sub>) battery

Type Sealed lithium, 12V, 10 amp-hours.

Certification FAA: TSO-C142 (Battery 3201856)

Capacity Typical: 416 full discharges or 18 hours of "on time" with a new battery.  
 Minimum: 306 full discharges with a new battery.

Shelf Life Five years

Weight 0.5 kg (1.2 lb)

Physical Characteristics

Height 10.2 cm (4.0 in)

Width 26.7 cm (10.5 in)

Depth 29.5 cm (11.6 in) including handle.

Weight 2.76 kg (6.1 lb) without battery or electrodes (monophasic).  
 2.41 kg (5.3 lb) without battery or electrodes (biphasic).



DEFIBRILLATOR

Waveform Monophasic pulse (Edmark) per AAMII DF2-1989

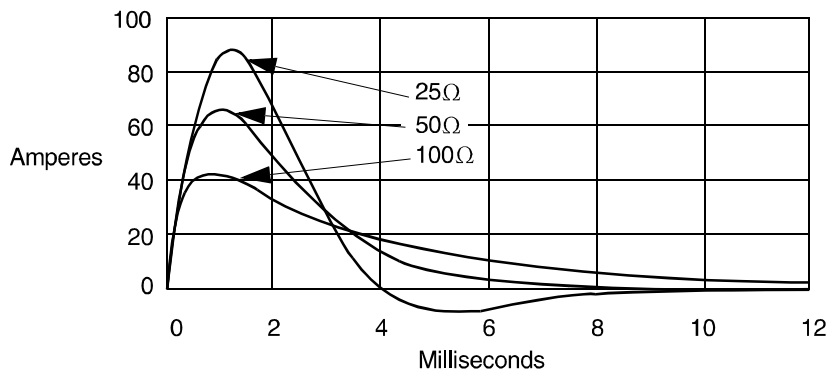

Waveform

Biphasic truncated exponential waveform

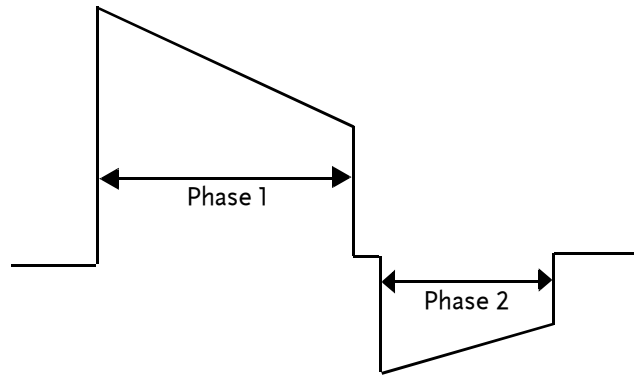

Patient Impedance ( $\Omega$ )	Phase 1 Duration (ms)		Phase 2 Duration (ms)		Tilt (%)	
	Min	Max	Min	Max	Min	Max
25	5.1	6.0	3.4	4.0	74.8	82.9
50	6.8	7.9	4.5	5.3	63.9	71.0
100	8.7	10.6	5.8	7.1	50.7	56.5
	9.5	11.2	6.3	7.4	46.3	51.6

Table 5-5 LIFEPAK 500 AED Battery Charger Specifications

**GENERAL**

Safety Classification	 Class II (double insulation), IEC 60601/EN 60601, 5.1
Input	100–240V 0.7–0.4A 50/60 Hz
Output	9.9Vdc for 10 hours, 9.2V trickle charge thereafter
Output Protection	Current limited, short circuit protected

**ENVIRONMENTAL**

Operating Temperature	15°–35°C (59°–95°F)
Water Resistance	IEC 60529/EN 60529 IPX0 (Indoor Use Only)

## CLINICAL SUMMARY: DEFIBRILLATION OF VENTRICULAR FIBRILLATION AND VENTRICULAR TACHYCARDIA

### Background

Medtronic conducted a multi-centered, prospective, randomized and blinded clinical trial of biphasic truncated exponential (BTE) shocks and conventional monophasic damped sine wave (MDS) shocks.<sup>1</sup> Specifically, the equivalence of 200J and 130J BTE shocks to 200J MDS shocks was tested.

### Methods

Ventricular fibrillation (VF) was induced in 115 patients during evaluation of implantable cardioverter defibrillator function and 39 patients during electrophysiologic evaluation of ventricular arrhythmias. After 19±10 seconds of VF, a customized defibrillator delivered an automatically randomized shock. Efficacy was based on success of this shock. To demonstrate equivalence of test shocks to control shocks, the 95% upper confidence limit of the difference in efficacy (95UCLD), control minus test, was required to be less than 10%.

### Results

#### Ventricular Fibrillation

The efficacy of the 200J BTE shocks was demonstrated to be at least equivalent to the efficacy of 200J MDS shocks (95UCLD=2%). The difference in success rates of 200J MDS minus 200J BTE shocks was -10% (exact 95% confidence interval from -27% to 4%). The 130J BTE shocks were not demonstrated equivalent to 200J MDS shocks (95UCLD=22%). However, neither was their efficacy significantly lower than that of the 200J MDS shocks (statistical power limited by small sample sizes). For all shock types, hemodynamic parameters (oxygen saturation and systolic and diastolic blood pressure) were at or near their pre-induction levels by 30 seconds after successful shocks.

Shock	Ventricular Fibrillation 1st Shock Success	Exact 95% Confidence Interval
200J MDS	61/68 (90%)	80–96%
200J BTE	39/39 (100%)	91–100%
130J BTE	39/47 (83%)	69–92%

<sup>1</sup> S.L. Higgins et al., "A comparison of biphasic and monophasic shocks for external defibrillation." *Prehospital Emergency Care*, 2000; 4(4): 305-13.

### Ventricular Tachycardia

Seventy-two episodes of ventricular tachycardia (VT), induced in 62 patients, were treated with randomized shocks. High rates of conversion were observed with biphasic and monophasic shocks. Sample sizes were too small to statistically determine the relationship between success rates of the waveforms tested.

Shock	Ventricular Tachycardia 1st Shock Success	Exact 95% Confidence Interval
200J MDS	26/28 (93%)	77–99%
200J BTE	22/23 (96%)	78–100%
130J BTE	20/21 (95%)	76–100%

### Conclusions

In this double-blinded study, the efficacy of the 200J BTE shocks was demonstrated to be at least equivalent to the efficacy of 200J MDS shocks for defibrillation of short duration, electrically-induced VF. However, the comparison of efficacy of 130J biphasic and 200J monophasic shocks for VF was inconclusive. All waveforms tested provided a high rate of termination of VT. The VT sample sizes were too small to statistically determine the relationship between VT success rates of the waveforms tested.

Compared to conventional shocks for VF, we found no positive or negative effect of biphasic shocks for VF on hemodynamic parameters following the defibrillating shock. It is possible that, compared to 200J monophasic shocks, 200J biphasic shocks will in some cases enable earlier termination of VF. Therefore, we conclude that biphasic shocks for VF delivered at conventional energy levels have the potential to improve outcome in resuscitation of patients with cardiac arrest.

## TROUBLESHOOTING

This section describes how to troubleshoot LIFEPAK 500 automated external defibrillator (AED) operating problems. This section also describes screen messages, voice prompts, and event types.

Troubleshooting During Patient Care	page 6-2
Troubleshooting During Modem Data Transfer	6-3
Troubleshooting During Printing	6-4
Troubleshooting During Setup Transfer	6-5
LIFEPAK 500 AED Screen Messages	6-6
LIFEPAK 500 AED Voice Prompts	6-8
LIFEPAK 500 AED Event Types	6-9

If you cannot correct the problem, follow these steps:

- Remove the AED from active service.
- Contact authorized service personnel for service and repair.

## TROUBLESHOOTING DURING PATIENT CARE

Table 6-1 Troubleshooting During Patient Care



Observation	Possible Cause	Corrective Action
<b>1 CONNECT ELECTRODES</b> message appears.	Inadequate connection to AED.  Electrode does not adhere properly to the patient.  Electrodes are dry, damaged, or out-of-date.	<ul style="list-style-type: none"> <li>• Check for complete insertion of connector to AED.</li> <li>• Press electrodes firmly on patient's skin.</li> <li>• Clean, shave, and dry the patient's skin as recommended.</li> <li>• Replace the electrodes.</li> </ul>
<b>2 MOTION DETECTED</b> and <b>STOP MOTION</b> messages appear during analysis.	Patient movement.  Patient movement because of agonal respirations.  Electrical/radio frequency interference.  Vehicle motion.	<ul style="list-style-type: none"> <li>• Stop CPR during analysis.</li> <li>• When patient is being manually ventilated, press <b>ANALYZE</b> after complete exhalation.</li> <li>• Press <b>ANALYZE</b> immediately after exhalation or wait until agonal respirations are slower or absent.</li> <li>• Move hand-held communication devices or other suspected devices away from the AED when possible.</li> <li>• Stop vehicle during analysis.</li> <li>• Move patient to stable location when possible.</li> </ul>
<b>3 LOW BATTERY</b>  message or indicators appear on readiness display and key panel.	Low battery.	<ul style="list-style-type: none"> <li>• If using AED, continue to use and replace battery at earliest convenience. When this indicator first appears, approximately 20% of battery energy remains.</li> <li>• If AED not in use, replace the battery immediately.</li> </ul>
<b>4 REPLACE BATTERY</b>  voice prompt or indicator on key panel flashes.	Very low battery.	<ul style="list-style-type: none"> <li>• Replace battery immediately.</li> </ul>
<b>5</b> Service indicators appear on readiness display and key panel ( <b>CALL SERVICE</b> message <i>not</i> displayed). 	A fault requiring service.	<ul style="list-style-type: none"> <li>• Continue to use the AED if it is needed. Contact authorized service personnel as soon as possible to repair the AED.</li> </ul>

Table 6-1 Troubleshooting During Patient Care (Continued)

Observation	Possible Cause	Corrective Action
6 Service indicator on key panel flashing and <b>CALL SERVICE</b> message appears.	 A fault requiring immediate service.	<ul style="list-style-type: none"> <li>Turn AED off and on. If the <b>CALL SERVICE</b> message appears again, remove the AED from active service. Immediately contact authorized service personnel to repair the AED.</li> </ul>
7 AED displays no messages after you repeatedly press <b>ON/OFF</b> .	Depleted battery. AED needs service.	<ul style="list-style-type: none"> <li>Replace the battery immediately.</li> <li>Contact authorized service personnel.</li> </ul>
8 <b>CHARGE REMOVED</b> message appears.	Electrode disconnects from patient or AED. <b>SHOCK</b> button not pressed within 15 seconds.	<ul style="list-style-type: none"> <li>Replace electrode and follow AED voice prompts.</li> <li>Press <b>SHOCK</b> within 15 seconds after the <b>PUSH TO SHOCK</b> message appears.</li> </ul>
9 Displayed time is incorrect.	Time is incorrectly set in the AED.	<ul style="list-style-type: none"> <li>Change the AED time setting.</li> </ul>
10 Date printed on report is incorrect.	Date is incorrectly set in the AED.	<ul style="list-style-type: none"> <li>Change the AED date setting.</li> </ul>
11 Displayed messages are faint or flicker.	Low battery power. Out of Temperature Range.	<ul style="list-style-type: none"> <li>Replace the battery immediately.</li> </ul>
12 Voice prompts sound faint or distorted.	Low battery power.	<ul style="list-style-type: none"> <li>Replace the battery immediately.</li> </ul>
13 AED operates but LCD is blank.	Operating temperature is too low or too high. LCD not operating properly.	<ul style="list-style-type: none"> <li>Operate the AED between 0° and 50°C (32°–122°F).</li> <li>Contact authorized service personnel.</li> </ul>
14 AED turns off or will not turn on.	Depleted battery.  Disconnected battery.	<ul style="list-style-type: none"> <li>Replace the battery immediately.</li> <li>Install battery.</li> </ul>

Table 6-2 Troubleshooting During Modem Data Transfer

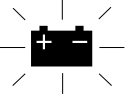
Observation	Possible Cause	Corrective Action
1 <b>BUSY</b> and <b>WILL RE-DIAL IN XX SECONDS</b> messages.	Destination number is busy, the AED is preparing to retry.	<ul style="list-style-type: none"> <li>Wait for the AED to retry the data transfer.</li> <li>AED will retry up to three times.</li> </ul>
2 <b>TRY AGAIN, TO SEND PUSH</b> or <b>CANNOT SEND</b> messages.	Transmission failed.  Wrong phone number.	<ul style="list-style-type: none"> <li>AED will retry up to three times.</li> <li>Check the destination phone number and <b>MODEM PHONE NUMBER</b> setup option.</li> </ul>

## Troubleshooting

Table 6-2 Troubleshooting During Modem Data Transfer (Continued)

Observation	Possible Cause	Corrective Action
<b>TRY AGAIN, TO SEND PUSH or CANNOT SEND</b> messages. (continued)	Cable is not properly connected.	<ul style="list-style-type: none"> <li>• Check connections.</li> </ul>
	Modem is not connected to an analog telephone line.	<ul style="list-style-type: none"> <li>• Confirm that the telephone line is analog (not digital).</li> </ul>
	Incorrect modem selected in Setup menu.	<ul style="list-style-type: none"> <li>• Check modem selected in <b>SETUP OPTIONS</b> menu.</li> </ul>
	Custom Modem Init String is incorrect.	<ul style="list-style-type: none"> <li>• Check <b>MODEM INIT STRING</b>.</li> </ul>
	Dial string for destination site is incorrect.	<ul style="list-style-type: none"> <li>• Check the AED <b>MODEM PHONE NUMBER</b> setup option.</li> </ul>
	Computer power at destination is not on.	<ul style="list-style-type: none"> <li>• Make sure the computer power is on.</li> </ul>
	Computer application program is not ready.	<ul style="list-style-type: none"> <li>• Make sure the program is ready to receive data.</li> </ul>
Connection failed or is busy. AED has tried to send data three times.	<ul style="list-style-type: none"> <li>• Resend the data.</li> </ul>	
<b>3 CONNECT ELECTRODES</b> message.	AED was turned on before modem.	<ul style="list-style-type: none"> <li>• Turn off the AED for one minute. Then, turn on the modem <i>before</i> the AED power and resend the data.</li> </ul>
<b>4 LOW BATTERY</b> message or indicators appear on readiness display and key panel.	 Low battery.	<ul style="list-style-type: none"> <li>• If using AED, continue to use and replace battery at earliest convenience. Approximately 20% of battery energy remains when indicator first appears.</li> <li>• If AED not in use, replace the battery immediately.</li> </ul>
<b>5 REPLACE BATTERY</b> voice prompt or indicator on key panel flashes.	 Very low battery.	<ul style="list-style-type: none"> <li>• Replace battery immediately.</li> </ul>

Table 6-3 Troubleshooting During Printing

Observation	Possible Cause	Corrective Action
<b>1 Printer does not print.</b>	No printer power.	<ul style="list-style-type: none"> <li>• Make sure the printer cord is connected.</li> <li>• Make sure the printer switch is on.</li> </ul>
	No printer paper.	<ul style="list-style-type: none"> <li>• Check the printer paper.</li> </ul>
	Printer cable not connected.	<ul style="list-style-type: none"> <li>• Check the printer cable connections.</li> </ul>

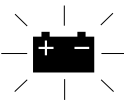

Table 6-3 Troubleshooting During Printing (Continued)

Observation	Possible Cause	Corrective Action
Printer does not print. (continued)	Wrong type of printer.	<ul style="list-style-type: none"> <li>Check the printer to make sure that it is EPSON ESC/P-compatible.</li> </ul>
2 Printed report does not line up properly on paper.	Wrong paper size selected.	<ul style="list-style-type: none"> <li>Make sure correct paper size is selected (8 1/2 x 11 or A4) in <b>SETUP OPTIONS</b> menu.</li> </ul>
3 <b>CONNECT ELECTRODES</b> message.	The ► button was not held down when the AED was turned on.	<ul style="list-style-type: none"> <li>Hold down the ► button while turning on the AED.</li> </ul>
4 <b>LOW BATTERY</b> message or indicators appear on readiness display and key panel.	Low battery. 	<ul style="list-style-type: none"> <li>If using AED, continue to use and replace battery at earliest convenience. Approximately 20% of battery energy remains when indicator first appears.</li> <li>If AED is not in use, replace the battery immediately.</li> </ul>
5 <b>REPLACE BATTERY</b> voice prompt or indicator on key panel flashes.	Very low battery. 	<ul style="list-style-type: none"> <li>Replace battery immediately.</li> </ul>

Table 6-4 Troubleshooting During Setup Transfer

Observation	Possible Cause	Corrective Action
Original AED displays <b>CANNOT SEND</b> message.	Setup Transfer Cable is not properly connected.	<ul style="list-style-type: none"> <li>Check the connections between the Setup Transfer Cable, the original AED, and the receiving AED.</li> </ul>
	Wrong cable is connected.	<ul style="list-style-type: none"> <li>Connect the Setup Transfer Cable to the original AED and the receiving AED.</li> </ul>
	Receiving AED is not on.	<ul style="list-style-type: none"> <li>Make sure the receiving AED is on.</li> </ul>
	Receiving AED was turned on with electrodes connected or while AED was connected to computer or modem.	<ul style="list-style-type: none"> <li>Turn the receiving AED off and on with the Setup Transfer Cable connected.</li> </ul>
	Receiving AED failed to receive transmission.	<ul style="list-style-type: none"> <li>Turn the receiving AED off and on with the Setup Transfer Cable connected.</li> </ul>

Table 6-5 LIFEPAK 500 AED Screen Messages

Screen Message	Description
<b>ANALYZING NOW</b>	The AED is analyzing the patient ECG rhythm.
<b>ASYSTOLE</b>	The AED has analyzed the patient's ECG and detected persistent asystole.
<b>ASYSTOLE DETECTOR</b>	Setup mode message for asystole time option.
<b>AUDIO RECORDING</b>	Setup mode message for the audio recording option.
<b>AUTO ANALYZE</b>	Setup mode message for auto analyze options.
<b>BATTERY OK</b>	The battery voltage is ok.
<b>BUSY</b>	While attempting to transfer data by modem, the AED detected that the destination phone number was busy.
<b>CALL SERVICE</b>	The AED detected a fault requiring immediate service during self-tests.
<b>CANNOT SEND</b>	The AED could not transfer the setup, print a report, or transfer data through a modem.
<b>CHARGE REMOVED</b>	The <b>SHOCK</b> button has been disarmed.
<b>CHECK FOR PULSE</b>	AED prompt after each standard three-shock sequence or <b>NO SHOCK ADVISED</b> message when <b>PULSE PROMPT 1</b> is selected in Setup.
<b>CHECK PATIENT</b>	AED prompt after each standard three-shock sequence or <b>NO SHOCK ADVISED</b> message when <b>PULSE PROMPT 2</b> is selected in Setup.
<b>CONNECT ELECTRODES</b>	The AED has detected that the electrodes are disconnected.
<b>CPR TIME XX SEC</b>	Setup mode message for the CPR timer option.
<b>CPSS DURING CPR</b>	Setup mode message for CPSS during CPR option.
<b>DEVICE ID XXXXXXXXXX</b>	Setup mode message for device ID option.
<b>ENERGY SEQUENCE #2-XXX</b>	Setup mode message for energy sequence option.
<b>IF NO PULSE</b>	AED prompt that follows the <b>CHECK FOR PULSE</b> message.
<b>IF NOT MOVING AND NOT BREATHING NORMALLY</b>	AED prompt that follows the <b>CHECK PATIENT</b> prompt when <b>PULSE PROMPT 2</b> is selected in Setup.
<b>LOW BATTERY</b>	The battery voltage is low.
<b>MODEM INIT STRING XXXXXXXXXXXXXXXXXXXXXX</b>	Setup mode message for the modem initialization string option.
<b>MODEM PHONE NUMBER XXXXXXXXXXXXXXXXXXXXXX</b>	Setup mode message for the modem phone number option.
<b>MODEM SELECTION # XX</b>	Setup mode message. You may select the configuration for one of nine Hayes AT-compatible modems.

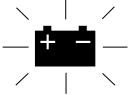
Table 6-5 LIFEPAK 500 AED Screen Messages (Continued)

Screen Message	Description
MOTION DETECTED	The AED detects motion during ECG analysis, thereby inhibiting analysis.
MOTION DETECTION	Setup mode message for motion detection option.
NO SHOCK ADVISED	The AED has analyzed the patient ECG and detected a nonshockable ECG rhythm.
PUSH ANALYZE	Press <b>ANALYZE</b> to begin ECG analysis.
PUSH TO SHOCK	The AED is fully charged and ready to provide therapy. This is the AED prompt to press <b>SHOCK</b> to discharge.
REPLACE BATTERY	The battery voltage is very low.
SELF-TEST XX.XX	The self-test is being performed and software version xx.xx is installed.
SEND COMPLETE	The AED successfully transferred data.
SENDING	The AED is transferring the setup to another AED.
SENDING XX% COMPLETE	The AED is transferring data by modem or to a printer. The transfer is xx% complete.
SETUP MODE nnnnnnnnnnnnnnnnnnnn	The AED is in the setup mode. The nnnnnnnnnnnnnnnnnnn is the Device Configuration code.
SHOCK ADVISED	The AED has analyzed the patient ECG rhythm and detected a shockable ECG rhythm.
STAND CLEAR	The AED prompt to move everyone away from the patient.
START CPR	The AED prompt that follows the <b>IF NO PULSE</b> message.
STOP MOTION	See <b>MOTION DETECTED</b> .
TEST MODE	The AED has entered the test mode.
TEST OK	The external test load test has been successfully completed.
TO PRINT PUSH ►	The AED is connected to a printer and ready to print a report.
TO SEND PUSH ►	The AED is connected to a modem and ready to transfer data.
TRANSFER SETUP TO SEND PUSH ►	Setup mode message for the Transfer Setup feature.
TRY AGAIN	The AED is ready for you to retry transferring data by modem.
WILL RE-DIAL IN XX SECONDS	While attempting to transfer data by modem, the AED detected that the destination phone number was busy. The AED will try again in xx seconds.

Table 6-6 LIFEPAK 500 AED Voice Prompts

Voice Prompt	Description
<b>ANALYZING NOW, STAND CLEAR</b>	The AED is analyzing the patient ECG rhythm.
<b>ASYSTOLE</b>	The AED has analyzed the patient ECG and detected persistent asystole.
<b>CHECK FOR PULSE</b>	Check the patient for a pulse.
<b>CHECK PATIENT</b>	AED prompt after each standard three-shock sequence or <b>NO SHOCK ADVISED</b> message when <b>PULSE PROMPT 2</b> is selected in Setup.
<b>CONNECT ELECTRODES</b>	The AED detects that the electrodes are disconnected.
<b>IF NO PULSE, START CPR</b>	If patient pulse is not present, start CPR.
<b>IF NO PULSE, PUSH ANALYZE</b>	If patient pulse is not present, press <b>ANALYZE</b> .
<b>IF NOT MOVING AND NOT BREATHING NORMALLY</b>	AED prompt that follows the <b>CHECK PATIENT</b> prompt when <b>PULSE PROMPT 2</b> is selected in Setup.
<b>MOTION DETECTED, STOP MOTION</b>	The AED detects motion during ECG analysis.
<b>NO SHOCK ADVISED</b>	The AED has analyzed the patient ECG and detected a non-shockable ECG rhythm.
<b>PUSH ANALYZE</b>	Press <b>ANALYZE</b> to begin ECG analysis.
<b>REPLACE BATTERY</b>	The battery voltage is low and must be replaced immediately.
<b>SHOCK ADVISED</b>	The AED has analyzed the patient ECG and detected a shockable ECG rhythm.
<b>STAND CLEAR</b>	Move away and do not touch patient.
<b>STAND CLEAR, PUSH TO SHOCK</b>	The AED is fully charged and ready to provide therapy. This is the AED prompt to move everyone away from the patient, then press <b>SHOCK</b> to discharge.

Table 6-7 LIFEPAK 500 AED Event Types

Possible Event Types*
<b>Event Log Report</b>
POWER ON
PATIENT CONNECTED
ANALYSIS X
SHOCK X - XXXJ
CPR PROMPT
CHECK PATIENT
CHARGE REMOVED
BATTERY REMOVED
BATTERY REPLACED
MOTION DETECTED
ANALYSIS STOPPED
OUT OF EVENT MEMORY
OUT OF ECG MEMORY
OUT OF SCENE AUDIO MEMORY
POWER OFF
<b>Event Log Summary</b>
FIRST ANALYSIS
FIRST SHOCK
# SHOCK(S) DELIVERED

\* These events and all voice prompts may appear in the Event Log Report.



To Purchase, Visit [Avobus.com](http://Avobus.com) or call [1-800-674-3655](tel:1-800-674-3655)

## **APPENDIX A SHOCK ADVISORY SYSTEM**

This section describes the basic function of the Shock Advisory System (SAS).





## OVERVIEW OF THE SHOCK ADVISORY SYSTEM

The Shock Advisory System (SAS) is an ECG analysis system built into the LIFEPAK 500 AED that advises the operator if it detects a shockable or nonshockable rhythm. This system makes it possible for individuals not trained to interpret ECG rhythms to provide potentially lifesaving therapy to victims of ventricular fibrillation or pulseless ventricular tachycardia. The Shock Advisory System contains the following features:

- Electrode contact determination
- Automated interpretation of the ECG
- Operator control of shock therapy
- Continuous Patient Surveillance System
- Motion detection

### Electrode Contact Determination

The patient's transthoracic impedance is measured through the defibrillation electrodes. If the baseline impedance is higher than a maximum limit, it is determined that the electrodes are not in sufficient contact with the patient or not properly connected to the AED. ECG analysis and shock delivery are inhibited. The operator is advised to connect electrodes any time electrode contact is inadequate. If you continue to get a **CONNECT ELECTRODES** message, remove electrodes and make sure skin is clean and dry. Shave excessive hair and apply a new set of electrodes.

### Automated Interpretation of the ECG

The Shock Advisory System is designed to recommend a shock if it detects the following:

- **Ventricular fibrillation** — with a peak-to-peak amplitude of at least 0.08 mV
- **Ventricular tachycardia** — defined as having a heart rate of at least 120 beats per minute, QRS width of at least 0.16 seconds, and no apparent P waves.

Pacemaker pulses may prevent advisement of an appropriate shock, regardless of the patient's underlying rhythm. The Shock Advisory System is designed to recommend no shock for all other ECG rhythms, including asystole, pulseless electrical activity, idioventricular rhythms, bradycardia, supraventricular tachycardias, and normal sinus rhythms.

ECG analysis is performed on consecutive 2.7-second segments of ECG. The analysis of two out of three consecutive segments must agree before a decision (**SHOCK ADVISED** or **NO SHOCK ADVISED**) is made.

The LIFEPAK 500 AED's SAS performance for adult and pediatric ECGs is summarized in the following tables.

Table A-1 LIFEPAK 500 AED SAS Performance Table for Adult ECGs

Rhythm Class	ECG Test <sup>1</sup> Sample Size	Performance Goal <sup>2, 3</sup>	Observed Performance Sensitivity or Specificity [LCL] <sup>4</sup>
Shockable: coarse VF	168	>90% sensitivity	100.0% [98.6%]
Shockable: shockable VT	65	>75% sensitivity	84.6% [77.3%]
Nonshockable: NSR	144	>99% specificity for NSR (AHA)	100.0% [98.4%]



Table A-1 LIFEPAK 500 AED SAS Performance Table for Adult ECGs (Continued)

Rhythm Class	ECG Test <sup>1</sup> Sample Size	Performance Goal <sup>2, 3</sup>	Observed Performance Sensitivity or Specificity [LCL] <sup>4</sup>
Nonshockable: asystole	43	>95% specificity	100.0% [94.8%]
Nonshockable: all other rhythms	531	>95% specificity	95.7% [94.3%]
Intermediate: fine VF	29	Report only	86.2% [74.3%] sensitivity

- From Medtronic ECG database. Each sample is run 10 times asynchronously.
- Association for the Advancement of Medical Instrumentation. DF39-1993 Standard for Automatic External Defibrillators and Remote-Control Defibrillators. Arlington, VA: AAMI;1993.
- Automatic External Defibrillators for Public Access Defibrillation: Recommendations for Specifying and Reporting Arrhythmia Analysis Algorithm Performance, Incorporating New Waveforms, and Enhancing Safety. AHA Task Force on Automatic External Defibrillation, Subcommittee on AED Safety and Efficacy. *Circulation*, 1997, Vol. 95, 1677-1682.
- LCL = 90% exact one-sided lower confidence limit  
VF = ventricular fibrillation  
VT = ventricular tachycardia  
NSR = normal sinus rhythm

The LIFEPAK 500 defibrillator was also tested using ECGs acquired from hospitalized pediatric patients ranging in age from < 1 day old to 17 years old. The results are summarized in Table A-2.

Table A-2 LIFEPAK 500 AED SAS Performance Table for Pediatric ECGs

Rhythm Class	ECG Test <sup>1</sup> Sample Size	Performance Goal <sup>2</sup>	Observed Performance Sensitivity or Specificity [LCL] <sup>3</sup>
Shockable: coarse VF	90	>90% sensitivity	98.9% [95.7%]
Shockable: shockable VT	11	>75% sensitivity	54.5% [31.8%]
Nonshockable: NSR	424	>99% specificity	100.0% [99.5%]
Nonshockable: asystole	95	>95% specificity	100.0% [97.6%]
Nonshockable: all other rhythms	433	>95% specificity	98.8% [97.9%]
Intermediate: fine VF	4	Report only	100.0% [56.2%] sensitivity
Intermediate: other VT	7	Report only	42.9% [17.0%] specificity

- From Medtronic ECG database.
- Automatic External Defibrillators for Public Access Defibrillation: Recommendations for Specifying and Reporting Arrhythmia Analysis Algorithm Performance, Incorporating New Waveforms, and Enhancing Safety. AHA Task Force on Automatic External Defibrillation, Subcommittee on AED Safety and Efficacy. *Circulation*, 1997, Vol. 95, 1677-1682.
- LCL = 90% exact one-sided lower confidence limit.

## Control of Shock Therapy

### Operator Control of Shock Therapy

The Shock Advisory System causes the AED to charge automatically when it detects the presence of a shockable rhythm. When a shock is advised, the operator remains in control of when the shock is delivered.

### Continuous Patient Surveillance System

The Continuous Patient Surveillance System (CPSS) automatically monitors the patient's ECG rhythm for a potentially shockable rhythm while the electrodes are attached and the AED is turned on. CPSS is not active during ECG analysis.

Motion detection is not active during the CPSS. Therefore, there is a chance that motion distortion in the ECG rhythm may be interpreted by CPSS as a potentially shockable rhythm.

### Motion Detection

The Shock Advisory System detects patient motion independent of ECG analysis. A motion detector is designed into the LIFEPAK 500 AED. **MOTION DETECTION** can be configured in the setup mode to be **ON** or **OFF**.

Motion can be caused by CPR, rescuer movement, patient movement, vehicle movement, or other causes. If variations in the transthoracic impedance signal exceed a maximum limit, it is determined that patient motion of some kind is present. ECG analysis is inhibited until the motion ceases. The operator is advised any time motion is detected during an analysis by a displayed message, a voice prompt, and an audible alert. If the motion does not cease within 20 seconds, analysis attempts will stop until the operator presses the **ANALYZE** button again. For LIFEPAK 500 AEDs without an **ANALYZE** button, analysis restarts automatically. If the motion does cease within 20 seconds, ECG analysis proceeds automatically.

There are two reasons why ECG analysis is inhibited when motion is detected:

- 1 Such motion may cause artifact in the ECG signal. This artifact can cause a nonshockable ECG rhythm to look like a shockable rhythm. For example, chest compressions during asystole can look like shockable ventricular tachycardia. Artifact can also cause a shockable ECG rhythm to look like a nonshockable rhythm. For example, chest compressions during ventricular fibrillation can look like an organized and, therefore, nonshockable rhythm.
- 2 The motion may be caused by a rescuer's interventions. To reduce the risk of inadvertently shocking a rescuer, the motion alert prompts the rescuer to move away from the patient. This will stop the motion and ECG analysis will proceed.



To Purchase, Visit [Avobus.com](http://Avobus.com) or call [1-800-674-3655](tel:1-800-674-3655)

## **APPENDIX B LIFEPAK 500 OPERATOR'S CHECKLIST**

This Operator's Checklist may be reproduced.



**LIFEPAK® 500**  
**Automated External Defibrillator**  
**OPERATOR'S CHECKLIST**

Unit Serial No.: \_\_\_\_\_  
 Location: \_\_\_\_\_

This is a suggested checklist for inspecting and checking this device on a daily basis and after each use. You may also consult JAMA, August 22/29, 1990, Vol. 264, No. 8, Table 3 for the Defibrillator Working Group's automated defibrillator checklist.



This form may be reproduced.

Instruction	Recommended Corrective Action	Date							
		Initials							

Insert a ✓ in the box after completing each instruction.

**1 Examine the AED case, connector, and battery well for:**

Foreign substances

Clean the device.

Damage or cracks

Contact authorized service personnel.

**2 Examine the battery pins for bending or discoloration.**

Discard and replace battery.

--	--	--	--	--	--	--	--	--	--

**3 Check expiration date on batteries and therapy electrodes.**

Replace if expired.

--	--	--	--	--	--	--	--	--	--

**4 Examine the accessory cables for cracked, damaged, broken, or bent connectors or wires.**

Replace damaged or broken parts.

--	--	--	--	--	--	--	--	--	--

**5 With the battery installed, press On/Off to turn on the AED and look for:**

Self-test messages

If absent, contact authorized service personnel.

Momentary illumination of each LED and all LCD segments

If absent, contact authorized service personnel to repair or replace parts.

**BATTERY LOW** or **REPLACE BATTERY SELF-TEST XX.XX** message

Replace the battery immediately.

Service indicator or **CALL SERVICE** message

Contact authorized service personnel.



To Purchase, Visit [Avobus.com](http://Avobus.com) or call [1-800-674-3655](tel:1-800-674-3655)





## **APPENDIX C FAST-PATCH DEFIBRILLATION CABLE INSTRUCTIONS FOR USE**



To Purchase, Visit [Avobus.com](http://Avobus.com) or call [1-800-674-3655](tel:1-800-674-3655)

**Instructions for Use**

**Introduction**

To use FAST-PATCH disposable defibrillation/ECG electrodes, the LIFEPAK 500 automated external defibrillator (AED) requires this FAST-PATCH defibrillation cable (see Figure C-1).

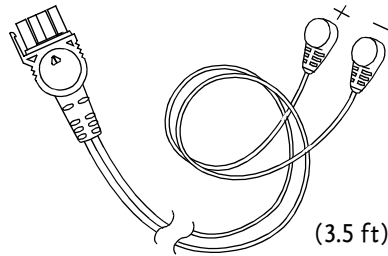



Figure C-1 FAST-PATCH defibrillation cable for the LIFEPAK 500 AED

**WARNING!**  
Inability to deliver therapy.  
Only FAST-PATCH electrodes can be used with the FAST-PATCH defibrillation cable.

**CAUTION!**  
Possible Equipment Damage.  
To prevent water or foreign substance contamination, keep the protective cover for the AED connector closed or the defibrillation cable inserted when the device is not in use.

**Symbols**

The following symbols appear on the defibrillation cable:

-  Attention, consult accompanying documents
- + Positive terminal
- Negative terminal

**Important**

Operators should be thoroughly familiar with the *LIFEPAK 500 AED Operating Instructions* and the *FAST-PATCH Disposable Defibrillation/ECG Electrode Operating Instructions* before using this defibrillation cable.

**Cable Attachment**

A lanyard is provided to help prevent loss of the defibrillation cable.

To attach the lanyard:

- 1 Loop the lanyard around the AED connector-end of the cable (see Figure C-2).
- 2 Loop the defibrillation cable through the lanyard and around the AED handle (see Figure C-2).

- 3 Insert the cable firmly into the AED until a positive stop is felt (see Figure C-3).

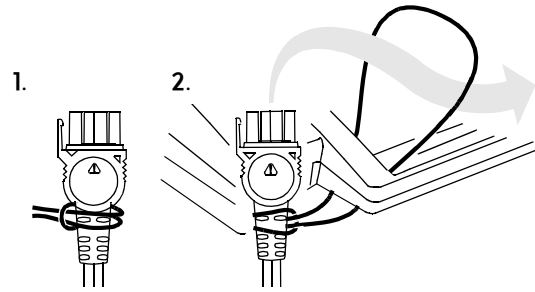

Figure C-2 Attaching lanyard

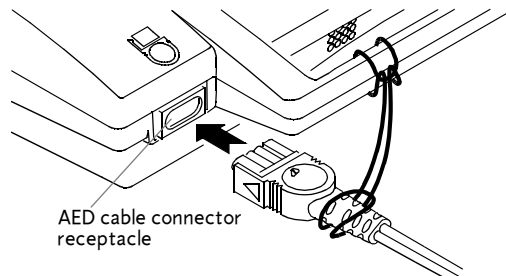

Figure C-3 Inserting defibrillation cable into AED

Remove the defibrillation cable for data transfer by pulling the connector straight out. Reconnect the defibrillation cable to the AED after data transfer, or close the protective cover on the AED cable connector.

**Connecting to FAST-PATCH Defibrillation/ECG Electrodes**

Properly connect the defibrillation cable to the electrodes to help ensure energy delivery (see Figure C-4).

- Attach the cable to the electrode post before attaching electrodes to the patient.
- Support the electrode post under the electrode when attaching the cable to the electrode.
- Firmly press the snap connector onto the electrode post until a click is heard or felt.
- Confirm a secure connection of the cable to the electrode before proceeding with therapy by pulling up gently on the snap connector.

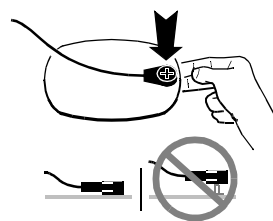

Figure C-4 Connecting to FAST-PATCH defibrillation/ECG electrodes

**Note:** If reattaching an electrode that is already on the patient, lift the adhesive edge under the electrode post slightly and place your finger under the post. Connect the cable as described.

## FAST-PATCH® Defibrillation Cable

for LIFEPAK® 500 Automated External Defibrillator

### Instructions for Use (continued)

---

#### Disconnecting from Disposable Electrodes

Disconnect the defibrillation cable from the electrode by pulling the snap connector straight up and off the post to avoid damage to the cable or the post (see Figure C-5).

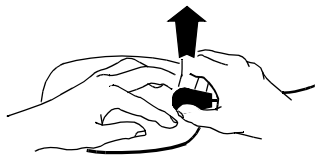

Figure C-5 Disconnecting from electrodes

---

#### Colors and Symbols

The defibrillation cable has colors and symbols on the snap connectors consistent with industry standards:

- AHA standards - red and white
- IEC standards - green and red

The snap connectors are labeled “+” (apex) and “-” (sternum). Refer to the *FAST-PATCH Electrode Operating Instructions* for electrode placement information.

---

#### Cleaning and Testing

To clean the FAST-PATCH defibrillation cable and snap connectors, wipe the surface with any one of the following:

- Mild soap and water
- Isopropyl alcohol
- Peracetic (peroxide) acid solutions
- Quaternary ammonium compounds
- Gluteraldehyde solutions

Contact local infection control resources for specific questions regarding cleaning procedures or cleaning agents available in your area.

- Do not immerse or soak the defibrillation cable.
- Do not use bleach or bleach dilution.
- Do not steam or gas sterilize.

Inspect and test the defibrillation cable on a routine basis. Inspection and testing will help ensure that the equipment is in good operating condition and is ready for use when needed. Use the Medtronic Patient Simulator to test the defibrillation cable.

If any discrepancy is detected with the defibrillation cable during inspection or testing, remove the defibrillation cable from service and immediately contact a qualified service representative.

---

#### Recycling Information

Recycle the device at the end of its useful life.

##### Preparation

The device should be clean and contaminant-free prior to being recycled.

##### Recycling Assistance

The device should be recycled according to national and local regulations. Contact your local Medtronic representative for assistance.

##### Recycling of Disposable Electrodes

After disposable electrodes are used, follow your local clinical procedures for recycling.

##### Packaging

Packaging should be recycled according to local and national regulations.

---

#### Ordering Information

Contact your local Medtronic sales or service office to order parts. In the USA, call the Medtronic PARTSLINE™ at 1.800.442.1142.

- FAST-PATCH defibrillation cable for LIFEPAK 500 AED (MIN 3010493)
- FAST-PATCH disposable defibrillation/ECG electrodes (MIN 3010188)
- Medtronic Patient Simulator (MIN 803499)

**APPENDIX D**  
**QUIK-COMBO DEFIBRILLATION CABLE INSTRUCTIONS FOR USE**



To Purchase, Visit [Avobus.com](https://www.avobus.com) or call [1-800-674-3655](tel:1-800-674-3655)



# QUIK-COMBO™ Defibrillation Cable

for LIFEPAK® 500 Automated External Defibrillator

## Instructions for Use

### Introduction

If using standard QUIK-COMBO pacing/defibrillation/ECG electrodes (PN 3010188) with the LIFEPAK 500 automated external defibrillator (AED), use the QUIK-COMBO defibrillation cable (PN 3011215) for additional length (see Figure D-1).

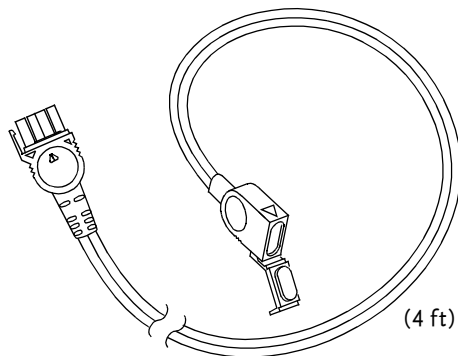

Figure D-1 QUIK-COMBO defibrillation cable for the LIFEPAK 500 AED

#### WARNING! Delay of Therapy

The QUIK-COMBO defibrillation cable is not compatible with Infant/Child Reduced Energy Defibrillation Electrodes. To use Infant/Child electrodes, remove the defibrillation cable and connect the Infant/Child electrodes to the AED.

#### CAUTION! Possible Equipment Damage.

To prevent water or foreign substance contamination, keep the protective cover for the AED connector closed or the defibrillation cable inserted when the device is not in use. Always keep the defibrillation cable protective cover closed when the cable is not in use.

### Symbols

The following symbols appear on the defibrillation cable:



Attention, consult accompanying documents



The QUIK-COMBO defibrillation cable is not compatible with the Infant/Child Reduced Energy Defibrillation Electrodes (MIN 3202380)

### Important

Operators should be thoroughly familiar with the *LIFEPAK 500 AED Operating Instructions* and the *QUIK-COMBO Pacing/Defibrillation/ECG Electrode Operating Instructions* before using this defibrillation cable.

### Cable Attachment

A lanyard is provided to help prevent loss of the defibrillation cable.

To attach the lanyard:

- 1 Loop the lanyard around the AED connector-end of the cable (see Figure D-2A).
- 2 Loop the lanyard around the handle of the AED and feed the defibrillation cable through the loop (see Figure D-2B).
- 3 Insert the cable firmly into the AED until a positive stop is felt (see Figure D-3).

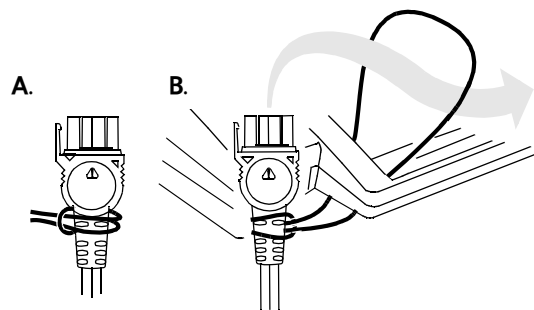

Figure D-2 Attaching lanyard

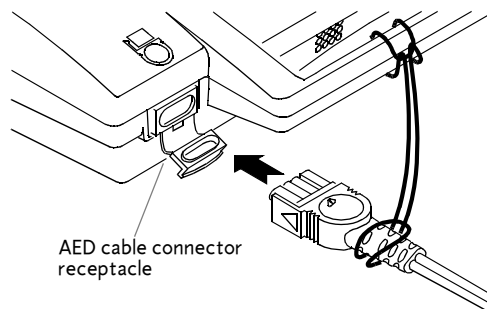

Figure D-3 Inserting defibrillation cable into AED

Remove the defibrillation cable for data transfer by pulling the connector straight out. Reconnect the defibrillation cable to the AED after data transfer, or close the protective cover on the AED cable connector.

After using the defibrillation cable, always close its protective cover.

## QUIK-COMBO™ Defibrillation Cable

for LIFEPAK® 500 Automated External Defibrillator

### Instructions for Use (continued)

#### Connecting to QUIK-COMBO Pacing/Defibrillation/ECG Electrodes

Properly connect the defibrillation cable to the electrodes to help ensure energy delivery (see Figure D-4).

- 1 Open the protective cover on the defibrillation cable connector.
- 2 Insert the QUIK-COMBO electrode connector into the defibrillation cable connector by aligning the arrows on the connectors and pressing the connectors firmly together for proper attachment.

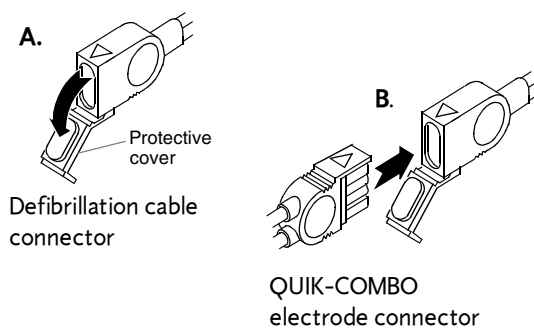

Figure D-4 Connecting QUIK-COMBO electrodes

#### Cleaning and Testing

To clean the QUIK-COMBO defibrillation cable, wipe the surface with any one of the following:

- Mild soap and water
- Isopropyl alcohol
- Peracetic (peroxide) acid solutions
- Quaternary ammonium compounds

Contact local infection control resources for specific questions regarding cleaning procedures or cleaning agents available in your area.

- Do not immerse or soak the defibrillation cable.
- Do not use bleach or bleach dilution.
- Do not steam or gas sterilize.

Inspect and test the defibrillation cable on a routine basis. Inspection and testing will help ensure that the equipment is in good operating condition and is ready for use when needed. Use the QUIK-COMBO Patient Simulator to test the defibrillation cable.

If any discrepancy is detected with the defibrillation cable during inspection or testing, remove the defibrillation cable from use and immediately contact a qualified service representative.

#### Recycling Information

Recycle the device at the end of its useful life.

#### Preparation

The device should be clean and contaminant-free prior to being recycled.

#### Recycling Assistance

The device should be recycled according to national and local regulations. Contact your local Medtronic representative for assistance.

#### Recycling of Disposable Electrodes

After disposable electrodes are used, follow your local clinical procedures for recycling.

#### Packaging

Packaging should be recycled according to national and local regulations.

#### Ordering Information



Contact your local Medtronic sales or service office to order parts. In the USA, call the Medtronic PARTSLINE™ at 1.800.442.1142.

- QUIK-COMBO defibrillation cable kit for LIFEPAK 500 AED (MIN 3011215)
- QUIK-COMBO Patient Simulator (MIN 803499)
- QUIK-COMBO pacing/defibrillation/ECG electrodes (2 ft lead wire) (MIN 3010188)
- QUIK-COMBO pacing/defibrillation/ECG electrodes with REDI-PAK™ preconnect system (MIN 3202674)



**APPENDIX E  
DECLARATIONS OF CONFORMITY /  
ELECTROMAGNETIC COMPATIBILITY GUIDANCE**

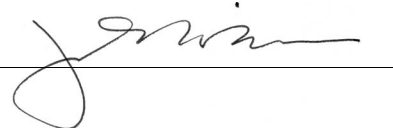

	<b>EC DECLARATION OF CONFORMITY</b>	
<b>Manufacturer's Name:</b> Medtronic Emergency Response Systems, Inc. <b>Manufacturer's Address:</b> 11811 Willows Road NE Redmond, WA 98052-2003 USA		
declares that the CE-marked product		
<b>Product Name:</b> LIFEPAK® 500 Automated External Defibrillator <b>Model Number:</b> 3011790 (biphasic only)		
complies with 93/42/EEC (Medical Device Directive) Class IIb, conformity assessed per Annex II.		
<b>Safety:</b> EN 60601-1:1996/ IEC 60601-1:1995 internally powered, Type BF, Continuous operation. IEC 60601-2-4:1983		
<b>EMC:</b> EN 60601-1-2:2001/IEC 60601-1-2:2001 EN 60601-2-4:2003 CISPR11 (Amd. A1:2004):2003 Class B, Group 1 EN 61000-4-2:20018kV CD, 15 kV AD IEC 61000-4-3:200210 V/m* (20 V/m EN 60601-2-4) IEC 61000-4-8:2001 3A/m		
<b>Supplementary Information:</b> Included are the following accessories and interconnecting cables:		
QUIK-COMBO™ electrode set, MIN 3010188 FAST-PATCH® electrodes, MIN 3010188 QUIK-COMBO pacing/defibrillation/ECG electrodes with REDI-PAK™ preconnect system, MIN 3202674 FAST-PATCH defibrillation cable, MIN 3010493 Sealed lead-acid battery, MIN 3005379 Lithium battery, MIN 3200390, 3005380 Battery Charger (non-medical), MIN 3006535 Data transfer cable (non-medical), MIN 3005381 Infant/Child Reduced Energy Defibrillation Electrodes (specially configured biphasic AEDs only), MIN 3202380 QUIK-COMBO Extension Cable, MIN 3009864		
This product also complies with:		
UL 2601-1:1994, CSA C22.2 No. 601.1 and CSA C22.2 No. 601.2.4, AAMI ES1, AAMI DF39		
Redmond, August 4, 2005		
		
James W. Dennison Vice President, Quality and Regulatory Affairs		
This declaration applies to CE marked devices produced after the date of issuance of this declaration and before it is either superseded by another declaration or withdrawn.		
Authorized EC Representative: Medtronic B.V., Earl Bakkenstraat 10, 6422 PJ Heerlen, The Netherlands		

\* See EMC tables



Ault Incorporated, 7105 Northland Terrace, Minneapolis, MN 55428-1534, 763-592-1900/Fax 763-592-1911

Visit our web site: [www.aultinc.com](http://www.aultinc.com), or contact us by e-mail: [info@aultinc.com](mailto:info@aultinc.com)



### EC DECLARATION OF CONFORMITY

We hereby declare under our sole responsibility that the product model(s) BCWA-042000-100A and BCWA-042000-100N (MEDTRONIC LIFEPAK 500 Battery Charger), a power supply intended for use as a battery charger in household and other similar applications, to which this declaration relates, meets the requirements of the following New Approach Directives:

- **Electro-Magnetic Compatibility (EMC)** Directive 89/336/EEC
- **Low Voltage Directive (LVD)** 73/23/EEC and 93/68/EEC

This declaration is backed by third party assessment to the appropriate European Norm standards. Ault Incorporated is an ISO 9001 registered firm, Certificate Number FM11881.

Tim Cassidy  
Director, Corporate Engineering  
23 September 2004

Table E-1 Guidance and Manufacturer’s Declaration – Electromagnetic Emissions

Guidance and Manufacturer’s Declaration – Electromagnetic Emissions		
The LIFEPAK <sup>®</sup> 500 Automated External Defibrillator (AED) is intended for use in the electromagnetic environment specified below. The customer or the user of the LIFEPAK 500 AED should ensure that the defibrillator is used in such an environment.		
Emissions Test	Compliance	Electromagnetic Environment - Guidance
RF emissions CISPR 11	Group 1	The LIFEPAK 500 AED uses RF energy only for its internal function. Therefore, its RF emissions are very low and are not likely to cause any interference in nearby electronic equipment.
RF emissions CISPR 11	Class B	The LIFEPAK 500 AED is suitable for use in all establishments, including domestic establishments and those directly connected to the public low-voltage power supply network that supplies buildings used for domestic purposes.
Harmonic emissions IEC 61000-3-2	Not Applicable	
Voltage fluctuations/ flicker emissions IEC 61000-3-3	Not Applicable	

**Essential Performance**

The LIFEPAK 500 AED maintains safe and effective performance of the defibrillation therapy and patient monitoring functions when operated in the electromagnetic environment specified in Tables E-2 through E-4.

**Limitations Affecting Immunity to Electromagnetic Disturbances**

The level of protection from electromagnetic disturbances is limited by several factors, including requirements for protection from third-party defibrillators, patient safety isolation, and maintenance of adequate signal-to-noise ratios for processing of patient signals.

## Declarations of Conformity / Electromagnetic Compatibility Guidance

Table E-2 Guidance and Manufacturer's Declaration - Electromagnetic Immunity

Guidance and Manufacturer's Declaration - Electromagnetic Immunity			
The LIFEPAK 500 AED is intended for use in the electromagnetic environment specified below. The customer or the user of the LIFEPAK 500 AED should ensure that the defibrillator is used in such an environment.			
Immunity Test	IEC 60601 Test Level	Compliance Level	Electromagnetic Environment - Guidance
Electrostatic discharge (ESD) IEC 61000-4-2	±6 kV contact ±8 kV air	±8 kV contact ±15 kV air	The LIFEPAK 500 AED is suitable for use in a dry environment.
Electrical fast transient/burst IEC 61000-4-4	±2 kV for power supply lines ±1 kV for input/output lines	Not Applicable	Not Applicable
Surge IEC 61000-4-5	±1 kV differential mode ±2 kV common mode	Not Applicable	Not Applicable
Voltage dips, short interruptions and voltage variations on power supply input lines IEC 61000-4-11	<5 % $U_T$ (>95% dip in $U_T$ ) for 0.5 cycle 40% $U_T$ (60% dip in $U_T$ ) for 5 cycles 70% $U_T$ (30% dip in $U_T$ ) for 25 cycles <5 % $U_T$ (>95% dip in $U_T$ ) for 5 s	Not Applicable	Not Applicable
Power frequency (50/60 Hz) magnetic field IEC 61000-4-8	3 A/m	3 A/m	Power frequency magnetic fields should be at levels characteristic of a typical location in a typical commercial or hospital environment.
<b>Note:</b> $U_T$ is the a.c. mains voltage prior to application of the test level.			

Table E-3 Guidance and Manufacturer’s Declaration - Electromagnetic Immunity

Guidance and Manufacturer’s Declaration - Electromagnetic Immunity			
The LIFEPAK 500 AED is intended for use in the electromagnetic environment specified below. The customer or the user of the LIFEPAK 500 AED should ensure that the defibrillator is used in such an electromagnetic environment.			
Immunity Test	IEC 60601 Test Level	Compliance Level	Electromagnetic Environment - Guidance
Conducted RF IEC 61000-4-6	3 Vrms 150 kHz to 80 MHz outside ISM bands <sup>a</sup>	Not Applicable	Portable and mobile RF communications equipment should be used no closer to any part of the LIFEPAK 500 AED, including cables, than the recommended separation distance calculated from the equation applicable to the frequency of the transmitter.  Recommended separation distance Not Applicable
	10 Vrms 150 kHz to 80 MHz in ISM bands <sup>a</sup>	Not Applicable	Not Applicable
Radiated RF IEC 61000-4-3	10 V/m 80 MHz to 2.5 GHz	10 V/m 80 MHz to 870 MHz, 910 MHz to 1500 MHz, 1624 MHz to 2.5 GHz  3 V/m 870 MHz to 910 MHz, 1500 MHz to 1624 MHz	$d = 1.2 \sqrt{P}$ 80 MHz to 800 MHz $d = 2.3 \sqrt{P}$ for specified frequencies in the range 800 MHz to 2.5 GHz  $d = 7.7 \sqrt{P}$ for specified frequencies  Where $P$ is the maximum output power rating of the transmitter in watts (w) according to the transmitter manufacturer and $d$ is the recommended separation distance in meters (m). <sup>b</sup> Field strengths from fixed RF transmitters, as determined by an electromagnetic site survey, <sup>c</sup> should be less than the compliance level in each frequency range. Interference may occur in the vicinity of equipment marked with the following symbol: 
<p><b>Note 1:</b> At 80 MHz and 800 MHz, the higher frequency range applies.</p> <p><b>Note 2:</b> These guidelines may not apply in all situations. Electromagnetic propagation is affected by absorption and reflection from structures, objects and people.</p>			

<sup>a</sup> The ISM (industrial, scientific and medical) bands between 150 kHz and 80 MHz are 6,765 MHz to 6,795 MHz; 13,553 MHz to 13,567 MHz; 26,957 MHz to 27,283 MHz; and 40,66 MHz to 40,70 MHz.

<sup>b</sup> The compliance levels in the ISM frequency bands between 150 kHz and 80 MHz and in the frequency range 80 MHz to 2.5 GHz are intended to decrease the likelihood that mobile/portable communications equipment could cause interference if it is inadvertently brought into patient areas. For this reason, an additional factor of 10/3 is used in calculating the recommended separation distance for transmitters in these frequency ranges.

<sup>c</sup> Field strengths from fixed transmitters, such as base stations for radio (cellular/cordless) telephones and land mobile radios, amateur radio, AM and FM radio broadcast and TV broadcast cannot be predicted theoretically with accuracy. To assess the electromagnetic environment due to fixed RF transmitter, an electromagnetic site survey should be considered. If the measured field strength in the location in which the LIFEPAK 500 AED is used exceeds the applicable RF compliance level above, the LIFEPAK 500 AED should be observed to verify normal operation. If abnormal performance is observed, additional measures may be necessary, such as re-orienting or relocating the LIFEPAK 500 AED.

Table E-4 Recommended Separation Distances

Recommended Separation Distances between Portable and Mobile RF Communications Equipment and the LIFEPAK 500 AED				
The LIFEPAK 500 AED is intended for use in an electromagnetic environment in which radiated RF disturbances are controlled. The customer or the user of the LIFEPAK 500 AED can help prevent electromagnetic interference by maintaining a minimum distance between portable and mobile RF communications equipment (transmitters) and the LIFEPAK 500 AED as recommended below, according to the maximum output power of the communications equipment.				
Rated maximum output power of transmitter W	Separation distance according to frequency of transmitter m			
	150 kHz to 80 MHz	80 MHz to 800 MHz $d = 1.2 \sqrt{P}$	80 MHz to 870 MHz, 910 MHz to 1500 MHz, 1624 MHz to 2.5 GHz $d = 2.3 \sqrt{P}$	870 MHz to 910 MHz, 1500 MHz to 1624 MHz $d = 7.7 \sqrt{P}$
0.01	Not Applicable	0.12	0.23	0.77
0.1	Not Applicable	0.38	0.73	2.43
1	Not Applicable	1.2	2.3	7.7
10	Not Applicable	3.8	7.3	24.3
100	Not Applicable	12	23	77
For transmitters rated at a maximum output power not listed above, the recommended separation distance $d$ in meters (m) can be determined using the equation applicable to the frequency of the transmitter, where $P$ is the maximum output power rating of the transmitter in watts (W) according to the transmitter manufacturer.				
<b>Note 1:</b> At 80 MHz and 800 MHz, the separation distance for the higher frequency range applies.				
<b>Note 2:</b> The ISM (industrial, scientific and medical) bands between 150 kHz and 80 MHz are 6,765 MHz to 6,795 MHz; 13,553 MHz to 13,567 MHz; 26,957 MHz to 27,283 MHz; and 40,66 MHz to 40,70 MHz.				
<b>Note 3:</b> An additional factor of 10/3 is used in calculating the recommended separation distance for transmitters in the ISM frequency bands between 150 kHz and 80 MHz and in the frequency range 80 MHz to 2.5 GHz to decrease the likelihood that mobile/portable communications equipment could cause interference if it is inadvertently brought into patient areas.				
<b>Note 4:</b> These guidelines may not apply in all situations. Electromagnetic propagation is affected by absorption and reflection from structures, objects and people.				



## INDEX

### A

#### Accessories

- Battery charger, 2-4
- Carrying case, 2-4
- Cleaning, 5-4
- Data cable, 2-4
- Inspection, 5-2
- Ordering, 5-14
- Part Numbers, 5-14
- QUIK-COMBO electrodes, 2-4
- Setup Transfer Cable, 2-4
- Test Load, 2-4

#### AED (automated external defibrillator)

- Accessories, Illustrations and descriptions, 2-4
- AED Prompts, 3-5
- Analysis cycle, 3-5
- Audio prompts and definitions, 6-8
- Battery maintenance, 5-7
- Cleaning, 5-4
- Connecting electrodes, 2-14

#### Controls, indicators, and connectors

- Descriptions, 2-2
- Illustration, 2-2
- Electrode placement, 3-3
- Initial Inspection, 2-2
- Inspection procedure, 5-2
- Maintenance schedule, 5-2
- No shock advised response, 3-6
- Overview of data storage and retrieval, 4-2
- Preparing for use, 3-2
- Printing reports, 4-9
- Procedure for analysis and defibrillation, 3-3
- Screen message definitions, 6-6
- Service and repair guidelines, 5-13
- Setup options, 2-7
  - Audio recording, 2-11
  - Auto analyze, 2-9
  - Device ID, 2-7
  - Modem phone number, 2-7
  - Modem selection, 2-8

#### Storage recommendations, 5-17

- Supplies and accessories, 5-14
- Testing, 5-4
  - Auto tests, 5-5
  - Self-test at power-on, 5-5
  - Service indicator and message, 5-4
  - Test load test, 5-6
- Troubleshooting, 6-2, 6-4
- Types of data and retrieval methods, 4-4
- Unpacking, 2-2
- AED Prompts, 3-5
- Analysis cycle, 3-5
- Analysis procedure, 3-3
- Analyze button description, 2-2
- Asystole Detector setup option, 2-11
- Asystole Detector setup option, 2-11
- Audio Alert setup option, 2-11
- Audio prompts and definitions, 6-8

- Audio recording
  - Definition, 4-2
  - Setup option, 2-11
- Audio recording setup option, 2-11
- Auto analyze setup option, 2-9
- Auto tests, 5-5
  - Daily auto test, 5-5
  - Extended auto test, 5-6
- B**
- Battery
  - Installation, 2-5
  - Low battery detection, 2-6
  - Recharging, 5-12
  - Recycling Rechargeable Battery Paks, 5-13
  - Removal, 2-6
- Battery charger, General description, 2-4
- Battery maintenance, 5-7
  - Nonrechargeable battery pak, 5-8
  - Rechargeable Battery Pak, 5-11
- C**
- Cable Connector
  - Types of possible connections, 2-3
- Call service message, 5-3
- Carrying case, General description, 2-4
- Cautions
  - Definition, 1-2
  - General caution, 1-3
- Charging battery, 5-12, 5-16
- Cleaning the AED, 5-4
- Clock
  - Changing the time and date, 2-6
- CODE SUMMARY Report
  - Description, 4-11
  - Example, 4-13
- Cold start description, 5-5
- Configuring the AED. *See* **Setup Options**
- Connecting electrodes to the AED, 2-14
- Controls, indicators, connectors AED
  - Descriptions, 2-2
  - Illustration, 2-2
- CPR countdown timer, 3-8
- CPR time
  - Messages, 3-8
  - Setup option, 2-12
- CPR time setup options, 2-9
- CPSS (Continuous Patient Surveillance System)
  - Overview, A-1
  - Typical scenario, 3-9
- CPSS during CPR setup option, 2-10
- Current patient record
  - Creating a new Current Patient Record, 4-3
  - Definition, 4-2
- D**
- Daily auto test, 5-5
- Data Retrieval
  - By a direct connection to a computer
    - Equipment connections, 4-8
    - Procedure, 4-8
    - Required resources, 4-8
    - Troubleshooting, 4-8
  - By modem to computer
    - Required resources, 4-5
    - Setup options, 4-5
    - Troubleshooting, 6-3, 6-4
- Data storage and retrieval
  - Overview, 4-2
  - Printing reports, 4-9
  - Types of data and retrieval method, 4-4
- Date/time setting, 2-6
- Defibrillation
  - General information, x
  - Procedure, 3-3
- Device ID setup option, 2-7
- Device Identification, 2-7
- Device Tracking, 1-ii
- Dial string character descriptions, 2-7
- Dial string for modem, 2-7
- Discharging nonrechargeable batteries paks, 5-10
- Display energy setup option, 2-9
- Disposing of nonrechargeable batteries paks, 5-10
- E**
- ECG analysis cycle, 3-5
- ECG Electrode placement, 3-3
- Electrode placement
  - ECG, 3-3
  - Implanted Defibrillators, 3-4
  - Implanted Pacemakers, 3-4
  - Obese patients, 3-4
  - Thin patients, 3-4
- Electrodes
  - How to connect, 2-14
  - Storage, 5-13
- Electrodes off detection, Message, 3-10
- Energy protocol setup option, 2-9
- Energy sequence setup option, 2-8
- Equipment connections, 4-6, 4-8, 4-10
- Event Log Report
  - Description, 4-10
  - Example, 4-12
- Event Log Summary
  - Description, 4-11
  - Example, 4-12
- Event type list, 6-9
- Extended auto test, 5-6
- External test load test, 5-6
- F**
- FAST-PATCH Electrodes, Placement, 3-3
- G**
- Guidelines for using the AED, xi
- H**
- Hazard communications, Definitions of terms, 1-2
- I**
- Illustration of AED, 2-2
- Implanted Defibrillators, Electrode placement, 3-4
- Implanted Pacemakers
  - Electrode placement, 3-4
- Incident ID, 4-7
- Incident ID setup option, 2-11
- Incident. *See* **Patient Records**
- Indicator, Low battery indicator, 2-3
- Infinite CPR Time, 3-8
- Inspection procedure, 5-2
- Installing a battery, 2-5

Intended use statements, x

## L

### LCD

General description, 2-3

Messages and definitions, 6-6

Location tracking of defibrillators,  
ii

Log Report. *See* **Event Log Report**

Log Summary. *See* **Event Log  
Summary**

Low battery detection, 2-6

Low battery indicator, General  
description, 2-3

## M

Maintenance and testing schedule  
for operators, 5-2

Manual text conventions, xiii

Messages and definitions, 6-6

### Modem cable

Connection, 4-6

General description, 2-4

Modem init string setup option,  
2-8

Modem phone number setup  
option, 2-7

Modem selection setup option,  
2-8

Motion detection setup option,  
2-11

Motion detection, Messages, 3-9

## N

No shock advised response, 3-6

### Nonrechargeable battery pak

Discharging, 5-10

Disposing, 5-10

General description, 2-4

Maintenance, 5-8

## O

ON/OFF button description, 2-2

Operator's Checklist, B-1

Ordering replacement parts, 5-14

## P

Paper size setup option, 2-11

Parts and supplies, 5-14

### Patient Records

Creating a new patient record,  
4-3

Current Patient Record, 4-2

Definition, 4-2

Previous Patient Record, 4-2

Patient transfer and QUIK-  
COMBO electrodes,  
3-10

### PC Data cable

Connection, 4-8

General description, 2-4

Phone number for modem, 2-7

Placing electrodes, 3-3

Power, Low battery indicator, 2-6

Power-on self test, 5-5

Preparing the AED for use, 3-2

Previous Patient Record,  
Definition, 4-2

Printed reports, Examples, 4-10

### Printer

Connection, 4-10

Type required, 4-9

### Printer cable

Connection, 4-9

General description, 2-4

Printing reports, 4-10

Procedure for analysis and  
defibrillation, 3-3

Pulse Prompt setup option, 2-10

Pushbutton descriptions, 2-2

## Q

### QUIK-COMBO Electrodes

Connecting, 2-14

General description, 2-4

Patient transfer, 3-10

Placement, 3-3

## R

### Rechargeable battery pak

General description, 2-4

Maintenance, 5-11

Recharging, 5-12

Recycling, 5-13

Recycling Rechargeable Battery  
Paks, 5-13

REDI-PAK electrode connections,  
2-14

Removing a battery, 2-6

Repair, 5-13

Replacement parts, 5-14

### Reports

Formats and examples, 4-12

Printing, 4-9

Types and definitions, 4-10

Rhythm analysis cycle, 3-5

Auto analyze feature, 2-9

Right arrow button, General  
description, 2-3

## S

SAS (Shock Advisory System),  
Overview, A-1

Schedule for maintenance and  
testing, 5-2

Screen messages, List and  
definitions, 6-6

Self test at power-on, 5-5

Sending data to a computer  
By direct connection, 4-8

By modem, 4-5

Sending data to a printer, 4-9

Service guidelines, 5-13

Service indicator, 2-3, 5-4, 5-16

Setting the clock, 2-6

Setup options, 2-7

Asystole detector, 2-11

Audio Alert, 2-11

Audio recording, 2-11

Auto analyze, 2-9

CPR time, 2-9

Device identification, 2-12

Display energy, 2-9

Energy protocol, 2-9

Energy sequence, 2-8

Factory default settings, 2-12

Incident ID, 2-11

Modem initialization string, 2-8

Modem phone number, 2-7

Modem selection, 2-8

Motion detection, 2-11

Paper size, 2-11

Pulse prompt, 2-10

Transfer Setup, 2-12

### Setup Transfer cable

Connection, 2-13

General description, 2-4

Shock Advised, 3-6

Shock Advisory System. *See* **SAS**

Shock button description, 2-3

Shock Counter, 3-9

Special situations for electrode  
placement, 3-4

Storage recommendations, 5-17

Supplies and accessories, 5-14

Symbol definitions, 1-3

**T**

- Telephone number for modem, 2-7
- Test load test, 5-6
- Test load, General description, 2-4
- Test Log Report, 4-4
  - Description, 4-11
  - Example, 4-16
- Test mode message, 5-6
- Testing the AED, 5-4
  - Auto tests, 5-5
    - Daily auto test, 5-5
    - Extended auto test, 5-6
  - Self test at power-on, 5-5
  - Service indicator and message, 5-5
  - Test load test, 5-4, 5-6
- Text conventions, xiii
- Time/date setting, 2-6
- Transfer setup feature. *See* **Setup options**
- Transfer setup setup option, 2-12
- Troubleshooting
  - During data transfer, 6-4
  - During patient care, 6-2
  - During printing, 6-4
  - During setup transfer, 6-5

**U**

- Unpacking the AED, 2-2
- Up arrow button, General description, 2-3

**V**

- Voice prompts and definitions, 6-8

**W**

- Warnings
  - Electrode use, 3-2
  - General warnings, 1-2
- Warnings and cautions, Definitions of terms, 1-2
- Warranty, 5-14
- Wrench symbol, 5-3

**USA Device Tracking**

The U.S. Food and Drug Administration classifies defibrillators as a medical device that requires tracking (knowing where the device is). As such, federal regulations require that manufacturers maintain tracking information for each device distributed. We rely on our customers to provide accurate device location information. This tracking information provides the manufacturer the ability to locate the device and perform a product correction, should it ever be needed.

Tracking information must specify the physical location of the device, not just the headquarters or receiving department's shipping address. The tracking information required is:

- 1 Customer name and department name
- 2 Physical address (actual physical location, for example, 123 Main Street, Third Floor, Suite A)
- 3 City, State, and Zip Code
- 4 A contact name and telephone number
- 5 Device part number and serial number

The address to which this particular device was shipped is the current tracking location. If this device is located somewhere other than the shipping address, or you have purchased this device from someone other than Medtronic, please either call the device tracking coordinator at 1.800.426.4448, or use one of the postage-paid address change cards below to update this vital information.

**Device Tracking Change Information**

<b>1</b>	Customer Name	Department Name
<b>2</b>	Physical Address (Please, no PO Box numbers)	
<b>3</b>	City	State      Zip
<b>4</b>	Contact Name	Telephone Number
<b>5</b>	Device Part Number	Serial Number

**Device Tracking Change Information**

<b>1</b>	Customer Name	Department Name
<b>2</b>	Physical Address (Please, no PO Box numbers)	
<b>3</b>	City	State      Zip
<b>4</b>	Contact Name	Telephone Number
<b>5</b>	Device Part Number	Serial Number

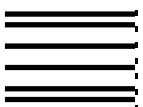

NO POSTAGE  
NECESSARY  
IF MAILED  
IN THE  
UNITED STATES

**BUSINESS REPLY MAIL**

FIRST CLASS PERMIT NO. 64 REDMOND, WA

Postage will be paid by addressee

Device Tracking Coordinator  
**MEDTRONIC**

P. O. Box 97006  
Redmond, WA 98073-9706

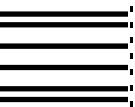

NO POSTAGE  
NECESSARY  
IF MAILED  
IN THE  
UNITED STATES

**BUSINESS REPLY MAIL**

FIRST CLASS PERMIT NO. 64 REDMOND, WA

Postage will be paid by addressee

Device Tracking Coordinator  
**MEDTRONIC**

P. O. Box 97006  
Redmond, WA 98073-9706





To Purchase, Visit [Avobus.com](http://Avobus.com) or call [1-800-674-3655](tel:1-800-674-3655)

**Medtronic Emergency Response Systems**

11811 Willows Road Northeast  
Redmond, WA 98052-2003 USA  
Telephone: 425.867.4000  
Toll Free (USA only): 800.442.1142  
Fax: 425.867.4121  
Internet: [www.medtronic-ers.com](http://www.medtronic-ers.com)  
[www.medtronic.com](http://www.medtronic.com)

**Medtronic Europe S.A.**

Medtronic Emergency Response Systems  
Rte. du Molliau 31  
Case postale 84  
1131 Tolochenaz  
Switzerland  
Telephone: 41.21.802.7000  
Fax: 41.21.802.7900

MIN 3005338-010 / CAT. 26500-001009

HEART AND VASCULAR DISEASE • NEUROLOGICAL DISORDERS • PAIN • SPINAL DISORDERS • DIABETES  
UROLOGIC DISORDERS • DIGESTIVE SYSTEM DISORDERS • EYE, EAR, NOSE AND THROAT DISORDERS



**Medtronic**

*Alleviating Pain • Restoring Health • Extending Life*

To Purchase, Visit [Avobus.com](http://Avobus.com) or call [1-800-674-3655](tel:1-800-674-3655)