

HeartStart FR3 Defibrillator

Guide to Setup, Operation, and Maintenance

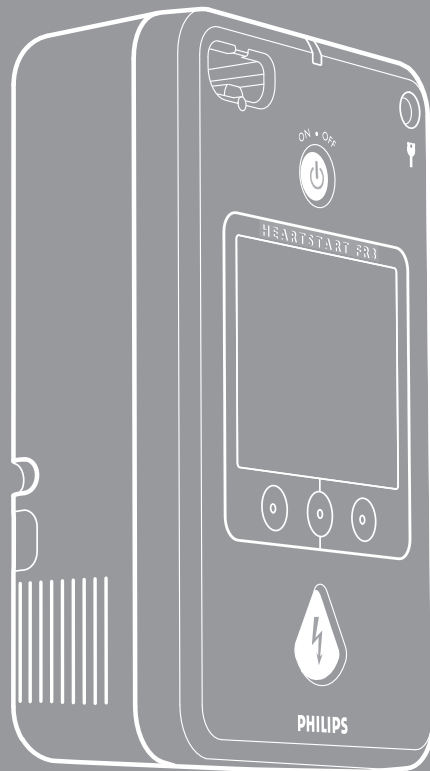

PHILIPS



To Purchase, Visit [Avobus.com](https://www.avobus.com) or call [1-800-674-3655](tel:1-800-674-3655)

INTENTIONALLY BLANK



HeartStart FR3

861388 / 861389

Automated External Defibrillator

GUIDE TO SETUP, OPERATION, AND MAINTENANCE

Edition I

IMPORTANT NOTE:

It is important to understand that survival rates for sudden cardiac arrest are directly related to how soon victims receive treatment. For every minute of delay, the chance of survival declines by 7% to 10%.

Treatment with CPR and defibrillation cannot assure survival. In some patients, the underlying problem causing the cardiac arrest is simply not survivable despite any available care.

About this edition

The information in this guide applies to the HeartStart FR3 Text model 861388 and FR3 ECG model 861389 defibrillators. This information is subject to change. Please contact Philips at www.philips.com/productdocs or your local Philips representative for information on revisions.

Edition history

Edition I

Publication date: November 2011

Publication number: 453564303641

Copyright

© 2011 Koninklijke Philips Electronics N.V.

No part of this publication may be reproduced, transmitted, transcribed, stored in a retrieval system or translated into any human or computer language in any form by any means without the consent of the copyright holder.

Unauthorized copying of this publication may not only infringe copyright but also reduce the ability of Philips Medical Systems to provide accurate and up-to-date information to users and operators alike.

Authorized EU representative

Philips Medizin Systeme Boeblingen GmbH
Hewlett-Packard Strasse 2
71034 Boeblingen, Germany
(+49) 7031 463-2254

CAUTION:

Federal law (USA) restricts this device to sale by or on the order of a physician.

Device tracking

This device is subject to tracking requirements by the manufacturer and distributors. If the defibrillator has been sold, donated, lost, stolen, exported, or destroyed, notify Philips Medical Systems or your distributor.

Device manufacturer

Philips Medical Systems, Seattle, WA 98121-1825, USA

Patents

This product is manufactured and sold under one or more of the following United States patents: US5591213, US5601612, US5607454, US5611815, US5617853, US5632280, US5650750, US5735879, US5749905, US5773961, US5776166, US5800460, US5803927, US5836993, US5868792, US5879374, US5889388, US5891046, US5891049, US5899926, US5902249, US5904707, US5951598, US5967817, US6016059, US6075369, US6185458, US6230054, US6234816, US6272385, US6287328, US6299574, US6317635, US6319031, US6350160, US6356785, US6405081, US6417649, US6441582, US6553257, US6556864, US6611708, US6871093, US7079894, and other patents pending.

The *Bluetooth*® word mark and logos are registered trademarks owned by Bluetooth SIG, Inc. and any use of such marks by Philips Medical Systems is under license. Koninklijke Philips Electronics, N.V., is an Associate Member of the Bluetooth SIG.

For Technical Support

If you need technical support, please contact your local Philips representative or go to www.philips.com/AEDsupport. Technical information about all Philips HeartStart automated external defibrillators, including clinical summaries of several key studies using Philips automated external defibrillators, is also available online at www.philips.com/productdocs, in the *Technical Reference Manuals* for HeartStart Automated External Defibrillators.



To Purchase, Visit Avobus.com or call [1-800-674-3655](tel:1-800-674-3655)

Heartstart FR3 Defibrillator

GUIDE TO SETUP, OPERATION, AND MAINTENANCE

CONTENTS

Description and Indications for Use	1
Intended User	1
Setup and Configuration	1
Installing the Optional FR3 Language Card and the Battery	2
Installing the Optional FR3 Data Card and the Battery	3
Setting the Date and Time	3
Connecting the HeartStart SMART Pads III	4
Automatic User-Initiated Test	5
Placing and Securing the FR3	5
Directions for Use	5
Maintenance and Cleaning	6
Routine Maintenance	6
After Each Use	7
User-Initiated Test	7
Cleaning	8
Troubleshooting	8
Indicators	8
Recommended Action in an Emergency	8
Safety Considerations	9
Symbols and Controls	11

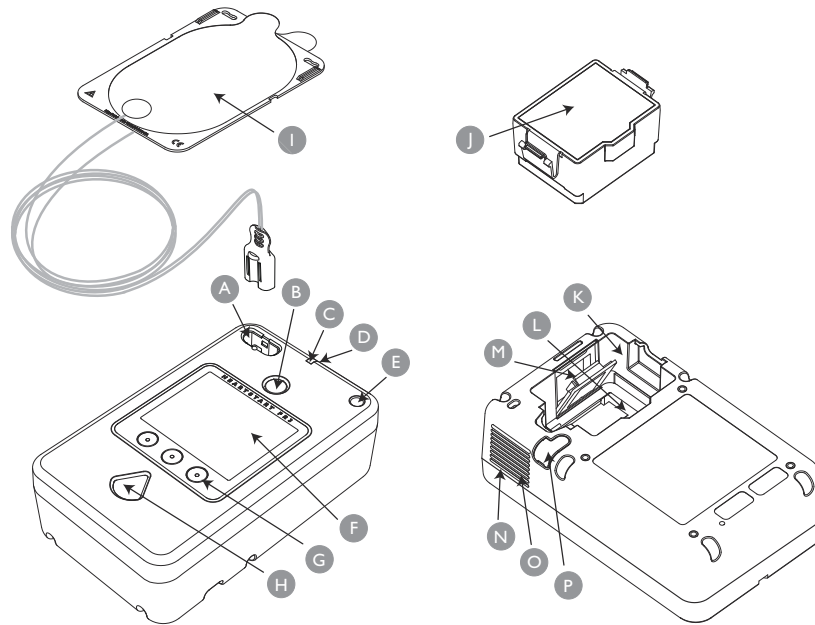

The HeartStart FR3 Defibrillator

A Defibrillator pads connector socket. Receptacle for the defibrillator pads cable connector. A light on the socket flashes when the FR3 is turned on to show socket location.

B Green On/Off button. Turns on the FR3 and starts voice and text prompts. A second press brings up the status screen, and then turns off the FR3.

C Green Ready light. Shows the readiness status of the FR3.

D Microphone. Used optionally to record audio during an incident.

E Infant/Child Key port. Accommodates the optional FR3 Infant/Child Key accessory to enable pediatric treatment protocols for patients under 55 lbs (25 kg) or 8 years old.

F Screen. Displays text prompts, graphics, and incident data. The FR3 ECG model also displays the patient's ECG if enabled.

G Option buttons (three). When pressed, activates the function identified on the screen.

H Orange Shock button. Controls shock delivery. The button flashes when the FR3 is ready to deliver a shock.

I SMART Pads III. Self-adhesive pads supplied with attached cable and connector. If using an optional FR3 system case and/or the Pads Sentry, store pads in Pads Sentry and pre-connect pads to FR3 for automatic self-test.

J Battery. Battery used to power the FR3.

K Battery compartment. Provides electrical connection for installed battery and contains data card slot and *Bluetooth*® wireless technology transceiver module compartment.

L Data card slot. Receptacle for optional data card accessory. Located beneath the battery in the battery compartment.

M Bluetooth wireless technology transceiver module compartment. Accommodates optional transceiver module accessory. Located behind a removable door in battery compartment.

N Speaker. Broadcasts FR3 voice prompts and alert tones when appropriate.

O Beeper. Broadcasts FR3 alert chirps when appropriate.

P Accessory port. Connection port for future use.

HEARTSTART FR3 DEFIBRILLATOR

DESCRIPTION AND INDICATIONS FOR USE

The HeartStart FR3 Defibrillator (FR3) is a compact, lightweight, battery-powered automated external defibrillator (AED) designed for use by trained responders to treat suspected victims of ventricular fibrillation (VF), the most common cause of sudden cardiac arrest (SCA), and certain ventricular tachycardias (VTs). The FR3 is used with disposable defibrillator pads applied to potential victims of SCA with the following symptoms:

- Unresponsiveness
- Absence of normal breathing

If in doubt, apply the pads, as illustrated.

The FR3 is intended for use on adults and children over 55 lbs (25 kg) or 8 years old. The FR3 is also intended for children under 55 lbs (25 kg) or 8 years old when used with the optional FR3 Infant/Child Key [REF: 989803150031]. If the Infant/Child Key is not available, or you are uncertain of the child's age or weight, do not delay treatment. Apply the pads as illustrated for a child and use the defibrillator.

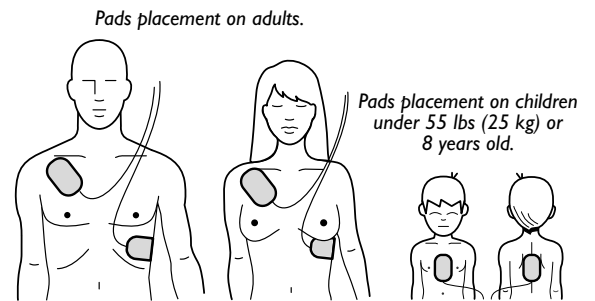

WARNING: Performance of the SMART CPR AUTO1 and AUTO2 settings for the CPR First feature has not been established in patients under 55 lb (25 kg) or 8 years old.

INTENDED USER

The HeartStart FR3 is intended for use by responders who have been trained in its operation and qualified by training in Basic Life Support (BLS), Advanced Life Support (ALS), or another physician-authorized emergency medical response program.

SETUP AND CONFIGURATION

The FR3 is shipped with a factory-default setup optimized for compliance with Guidelines 2010 to meet the needs of most users. However, the FR3 is extensively configurable. Any changes to default settings must be done under supervision of the Medical Director. Depending on the kind of changes you will be making, you will also need the following:

- *Changing the FR3 primary language:* the FR3 language card, provided with certain versions of the FR3 and also available separately [REF: 989803150101].
- *Changing the FR3 device operation, self-test options, patient care, defibrillation, and advanced use mode parameter settings:* the HeartStart Configure software [REF: 861438], available separately.
- *Enabling the FR3 bilingual option and selecting a secondary language:* the HeartStart Configure software and the FR3 language card.

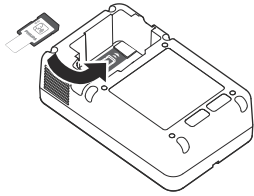

(Optional) Install the FR3 language card.

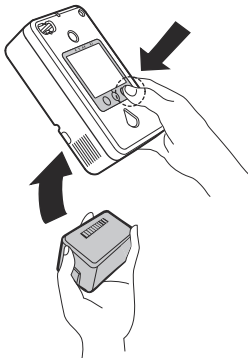

(Optional) Re-install the battery while holding down the right option button.

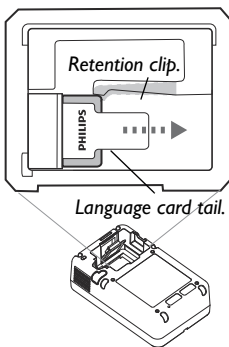

Battery compartment.

Setup with the optional FR3 language card and the optional FR3 data card is discussed below. See the *FR3 Instructions for Administrators* CD-ROM, provided with the FR3, for a list of all accessories and directions on setting up the FR3 with other optional accessories.

INSTALLING THE OPTIONAL FR3 LANGUAGE CARD AND THE BATTERY

The primary language is the language the FR3 uses for voice and text prompts. The FR3 can operate in any language that is provided on the FR3 language card.

If you do not want to change the default primary language, go to the following section, “Installing the Optional Data Card and the Battery.”

To change the default primary language to a different primary language, follow these steps:

1. Insert the FR3 language card into the data card slot in the bottom of the FR3 battery compartment. A label on the floor of the battery compartment shows the correct orientation for inserting the card. A retention clip helps hold the card in the slot. The tail on the data card serves as a visual reminder that a card is installed and aids in card removal.
2. Check the battery label to be sure the battery is within its install-by date. Remove the battery from its packaging. Install the battery in the FR3 battery compartment, *while holding down the right option button*. Keep the button pressed until the language selection screen is displayed. The FR3 display screen automatically provides a list of languages. There may be more than one screen of languages.
3. Press the ▼ option button to scroll to the language you want, then press the ✓ option button to select it. (If no selection is made within 60 seconds, the FR3 shuts down.) The new language file automatically loads. The FR3 displays the language name and a progress bar. During language installation, the FR3 cannot be turned off. When the language load is complete, the FR3 will operate in the new language. Other default or previously modified configuration settings will remain unchanged. The FR3 displays a screen for 10 seconds announcing that the setup is complete, and reminding you to remove the language card.
4. Now, remove the battery and the FR3 language card.* To remove the language card, grasp the data card by its tail, press the retention clip away from the card, and pull the card out. Store the language card in a safe place for future use or reference.
5. Insert an FR3 data card, if desired, in the data card slot (see following section), and reinstall the battery. As soon as the battery is installed, the FR3 automatically runs a detailed interactive user-initiated test. Press the buttons when directed, or the test will fail.
6. On completion of the test, the FR3 displays the results and then displays the main Administration screen. If the FR3 clock has not yet been set, the FR3 will provide a reminder message. See instructions below.
7. After setting the clock, press the green On/Off button to display the status screen and put the defibrillator into standby.

* If the language card is not removed, the FR3 will treat it as a data card and the original language files on the language card will not be overwritten. As a result, the capacity for data recording on the language card is less than on a data card.

- Philips recommends that you relabel the green On/Off button on the FR3 with the appropriate language decal from the set provided with the language card.

INSTALLING THE OPTIONAL FR3 DATA CARD AND THE BATTERY

The FR3 automatically stores summary data of last use in internal memory for later review on the display screen. However, if your protocol requires recording detailed information about the operation and use of the FR3, you must install an FR3 data card [REF: 989803150061], available separately.*

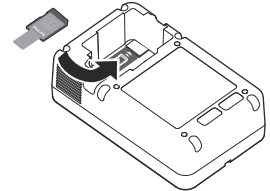

(Optional) Install the FR3 data card.

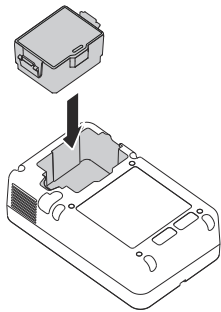

Install the battery.

- Insert the optional data card into the data card slot in the bottom of the FR3 battery compartment. A label on the floor of the battery compartment shows the correct orientation for inserting the card. A retention clip helps hold the card in the slot. The tail on the data card serves as a visual reminder that a card is installed and aids in card removal.
- Check the battery label to be sure the battery is within its install-by date. Remove the battery from its packaging. Install the battery in the FR3 battery compartment as shown. Be sure that both the battery's latches click into place.

As soon as the battery is installed, the FR3 automatically runs an interactive user-initiated test, if it has not already done so following removal of the language card, as described previously. Press the buttons when directed, or the test will fail.

SETTING THE DATE AND TIME

The first time you set up the FR3, it automatically runs a user-initiated test when the battery is inserted. When the test is complete, the FR3 displays a reminder that the clock is not set and a prompt to set the date and time.

The date format of the FR3 is the year in four digits, the name of the month, and the day in two digits. For example: 2010 February 17. The time format uses a 24-hour clock and shows two digits each for the hour, minute, and second. For example: 18:05:54. To check the clock and modify it, if needed, to match local date and time, follow these steps:

- Press the ADMINISTRATION option button to go to the ADMINISTRATION screen.†
- On the ADMINISTRATION screen, press the ▼ option button to scroll to SETUP, then press the ✓ option button to select it.
- On the SETUP screen, press the ▼ option button to scroll to DATE AND TIME, then press the ✓ option button to select it.
- On the DATE AND TIME screen, press the ▼ option button to stop the automatic time incrementing and display the CHANGE DATE AND TIME screen.

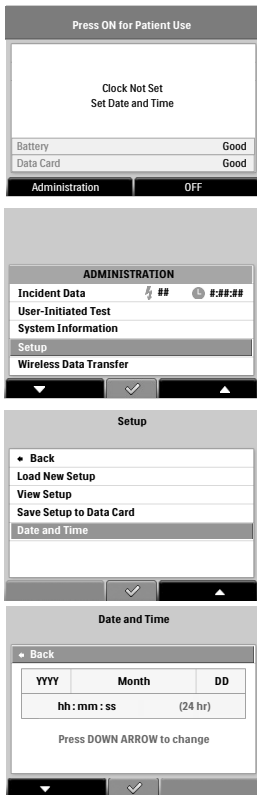

* Non-Philips data cards may not work properly with the FR3 system.

† If the FR3 is already in standby, press the green On/Off button to turn on the FR3. When voice prompts begin, press the button again to display the status screen.

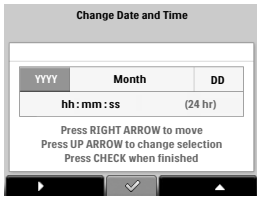

5. The year element of the date is highlighted when you first activate the CHANGE DATE AND TIME screen. To modify the year, press the ▲ option button until the correct value is displayed.*
6. Press the ► option button to move the highlight bar to the next element in the date or time. Press the ▲ option button to display the next value for a highlighted element. *Do not press the ✓ option button until you have made all modifications needed, or the process will have to be repeated.*
7. When you see the correct entry for the highlighted element, press the ► option button to move to the next element of the date and time. Repeat steps 6 and 7 for each element of the date and time you want to modify.
8. When you have completed all the changes needed, press the ✓ option button to accept the new date and time settings. The FR3 then displays the revised DATE AND TIME screen, with BACK highlighted.
9. Press the ✓ option button to exit the screen, then press the On/Off button to display the status screen and let the FR3 go into standby. The green Ready should be flashing to show that the FR3 is ready for use.

CONNECTING THE HEARTSTART SMART PADS III†

If you are NOT using an optional FR3 system case with a Pads Sentry, store your HeartStart SMART Pads III in their unopened package with the FR3 and ensure that the pads are protected from damage.

If you ARE using an FR3 system case with a Pads Sentry, follow these steps to pre-connect the pads:

1. Check the expiration date on the pads package. Open the package and take out the pads, leaving them on their liner. Leave the paper wrap on the coiled cable; it will tear off when you extend the cable to use the pads.
2. Insert the pads connector plug firmly into the FR3 pads connector port above the flashing light.
3. Keep the pads on their liner and place them in the Pads Sentry installed in the bottom of the system case, if used. The Pads Sentry shields the pads and provides a mechanism that allows the pads to be tested during each FR3 self-test. Place the coiled pad cables into the compartment provided in the case.

WARNING: Do not peel the pads from the liner until they are needed for use in an emergency.‡

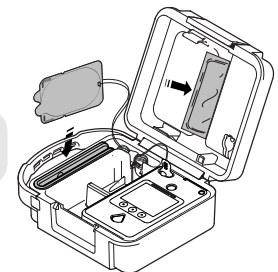

Place pads in Pads Sentry.
(Optional FR3 rigid system case is shown.)

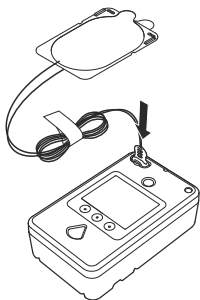

Connect the pads.

* If you pass the year you wish to select, continue to press the ▲ option button to scroll through the range of years (2000 through 2039) until the correct year is displayed again.
 † The FR3 also accepts use of HeartStart SMART Pads II [REF: 989803139261] and HeartStart Adult Defibrillation pads [REF: 989803158211 and 989803158221]. Do not pre-connect the Adult Defibrillation pads to the FR3, or the FR3 will not pass its self-tests.
 ‡ Peeling any part of the pads from the liner breaks the protective seal and allows the pads adhesive to dry out. If this happens, the pads will fail the FR3 self-test.

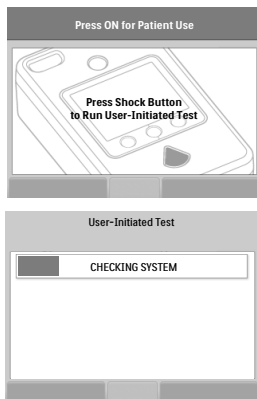

AUTOMATIC USER-INITIATED TEST

The first time you set up the FR3, the FR3 automatically runs a detailed user-initiated test as soon as the battery is in place. This test is designed to make sure the device and all connected accessories are ready for use. The first part of the test is interactive. Follow the prompts to press the buttons as instructed, or the test will fail. Then listen for two audio tones. If you do not hear the tones, there is a problem with the speaker or the beeper. Contact Philips at www.philips.com/AEDSupport for technical support. The second part of the test is automatic. The FR3 displays a progress bar indicating the test's progress.

IMPORTANT NOTE: Do not remove the battery during the user-initiated test. To abort the test, press the On/Off button to turn off the device.

NOTE: Do not connect or disconnect any accessories, such as the pads or Infant/Child Key, during the user-initiated test.

When the test is complete, the FR3 displays the results of the test, the device serial number, and the software revision, then displays the ADMINISTRATION screen. If for any reason the test fails, contact Philips at www.philips.com/AEDSupport for technical support.

Press the On/Off button to display the status screen and put the defibrillator into standby. If the FR3 passes the test, the green Ready light flashes to show the FR3 is ready for use. If the FR3 or any connected accessory fails the test for any reason, the screen displays information about the failure.



PLACING AND SECURING THE FR3

Place the FR3 in an accessible area where the green Ready light is easily visible and the FR3 alert chirps can be heard. Philips recommends that the defibrillator and pads be secured in a protective carry case, such as the FR3 rigid system case [REF: 989803149971], soft system case [REF: 989803150221], or small soft case [REF: 989803173711].

IMPORTANT NOTE: To ensure that the FR3 is ready for use when needed, store it *with the battery installed and the SMART Pads III connected* and installed in the Pads Sentry. Do not remove the battery unless the FR3 self-tests indicate that it should be replaced.

DIRECTIONS FOR USE

To use the FR3 in an emergency:

1. **TURN ON THE FR3.** Press the green On/Off button.

NOTE: If you store the defibrillator in a HeartStart FR3 case, the FR3 automatically turns on when you open the case lid. If for any reason the FR3 does not turn on automatically, or if you do not use an FR3 case, press the green On/Off button to turn on the FR3.

2. **FOLLOW THE VOICE AND TEXT PROMPTS.** The FR3 will direct you in each step of using it to treat a suspected victim of SCA. Place the pads as illustrated on page 1 of this manual. If the victim is under 55 lbs (25 kg) or 8 years old, insert the Infant/Child Key, if available, in the FR3 before placing the pads.

WARNING: Most cardiac arrests in children are not caused by heart problems. When responding to cardiac arrest in an infant or child:

- Provide infant/child CPR while a bystander calls EMS and brings the FR3.
 - If no bystander is available, provide 1-2 minutes of CPR before calling emergency medical systems and retrieving the FR3.
 - If you witnessed the child's collapse, call EMS immediately and then get the FR3.
- Alternatively, follow your local protocol.

3. If prompted by the FR3, **PRESS THE SHOCK BUTTON** to deliver a shock.

Leave the pads connected and the defibrillator turned on for continued monitoring and rhythm analysis, as appropriate. Continue to follow any voice and screen prompts the FR3 provides.

NOTE: The FR3 automatically runs periodic self-tests. While a self-test is running, the green Ready light is on steady, and the display is dark. If you press the On/Off button or open the FR3 carry case, the FR3 aborts the self-test and turns on for use.

MAINTENANCE AND CLEANING

ROUTINE MAINTENANCE

In addition to the self-test performed each time it is turned on and each time a battery is installed, the FR3 also automatically performs periodic self-tests. These include daily, weekly, and monthly self-tests of respectively increasing detail to verify readiness for use.

NOTE: The FR3 self-tests are designed to check that the FR3 is ready for use. However, in the event that the FR3 has been dropped or mishandled, Philips recommends that you run a user-initiated test. If the FR3 has visible signs of damage, contact Philips at www.philips.com/AEDSupport for technical support.

If the green Ready light is blinking and the FR3 is not chirping, the FR3 has passed its most recent self-test and is therefore ready for use. The defibrillator requires no calibration or verification of energy delivery. Routine maintenance is limited to periodically conducting the following steps:

- ✓ Check the green Ready light. If the green Ready light is not blinking or the FR3 is chirping, see Troubleshooting, below.
- ✓ Replace any expired supplies and accessories.
- ✓ Check the outside of the defibrillator. If you see signs of damage, contact Philips for technical support.

CAUTION: Electrical shock hazard. Dangerous high voltages and currents are present. Do not open the defibrillator, remove its covers, or attempt repair. There are no user-serviceable components in the FR3. Return the FR3 to Philips for repair.

AFTER EACH USE

- ✓ Follow your local guidelines and medical protocol to download incident data from the FR3 data card if one is installed. To ensure that data is not lost due to a full data card, Philips recommends that you replace a used FR3 data card with a blank FR3 data card after each use.
- ✓ Check the outside of the FR3 for signs of damage, dirt, or contamination. If you see signs of damage, contact Philips for technical support. If the defibrillator is dirty or contaminated, clean it as described below.
- ✓ Replace any used, damaged or expired items.
- ✓ Run a user-initiated test as described below.
- ✓ Press the On/Off button to display the status screen then let the FR3 go into standby to be ready for use. Note any messages displayed on the status screen prior to shutdown, and address them as appropriate.
- ✓ Return the FR3 to its storage location to be ready for use when needed.

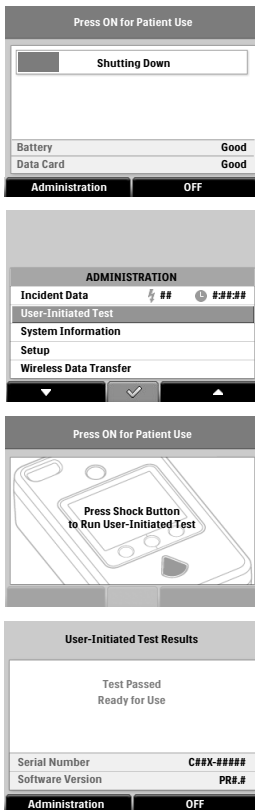

USER-INITIATED TEST

To run the user-initiated test, follow the steps below. However, as long as the green Ready light is flashing and the FR3 is not chirping, it is not necessary to test the defibrillator by initiating a test. This uses battery power and drains the battery prematurely.

1. Press the green On/Off button to start the FR3. When voice prompts begin, press the button again to display the status screen.
2. Before the progress bar on the status screen is filled, press the ADMINISTRATION option button.
3. On the ADMINISTRATION screen, press the ▼ option button to scroll to USER-INITIATED TEST, then press the ✓ option button to select it. The FR3 gives a tone and begins the test.
4. Follow the instructions on the screen. The first part of the test is interactive. Follow the prompts to press each button when instructed, or the test will fail. Then listen for two audio tones. If you do not hear the tones, there is a problem with the speaker or the beeper. Contact Philips at www.philips.com/AEDSupport for technical support.
5. The second part of the test is automatic. During the automatic part of the test, the screen displays a progress bar indicating the test's progress.
6. When the test is complete, the FR3 displays the results of the test, the device serial number, and the software version, then displays the ADMINISTRATION screen again.
7. Press the On/Off button to display the status screen and put the defibrillator into standby.
8. If the FR3 or any attached accessory fails the self-test for any reason, the screen displays information about the failure. If the FR3 passes the test, the green Ready light flashes to show that the FR3 is ready for use.

CLEANING

Make sure a battery is installed when cleaning the FR3, to keep fluids out of the device. The system case, if used, and the outside of the FR3, including the pads connector socket, can be cleaned with a soft cloth dampened in isopropyl alcohol (70% solution) in water, ammonia-based cleaners, mild soap and water, or sodium hypochlorite (chlorine bleach 3% solution in water). Do not use abrasive materials, cleaners, strong solvents such as acetone or acetone-based cleaners, or enzymatic cleaners.

CAUTION: Do not immerse any portion of the FR3 in water or other fluids. Do not allow fluids to enter the FR3. Avoid spilling any fluids on the FR3 or accessories. Spilling fluids into the FR3 may damage it or present a fire or shock hazard. Do not sterilize the FR3 or its accessories.

TROUBLESHOOTING

INDICATORS

The green Ready light is the signal that tells you if the FR3 is ready for use. Alert chirps tell you if the FR3 needs attention.

INDICATOR	MEANING
Ready light flashes	The FR3 has passed the user-initiated test or its most recent self-test and is therefore ready for use.
Ready light steady	The FR3 is in use or is conducting a self-test.
Ready light off, FR3 chirps	If the FR3 is giving <i>single chirps</i> , press the On/Off button to start the FR3. When voice prompts begin, press the button again to display the status screen for information about the status of the FR3 and how to resolve the problem. If the FR3 is giving <i>triple chirps</i> , press the On/Off button once to display the status screen for the error message. Record the error; turn off the FR3, and remove it from service. Contact Philips at www.philips.com/AEDSupport for technical support.
Ready light off, FR3 does not chirp, screen is blank	The battery is depleted or missing, or the FR3 needs repair. Insert or replace a battery. The FR3 automatically runs a power-on self-test. If the green Ready lights starts flashing, the FR3 has passed the self-test and is therefore ready for use.

RECOMMENDED ACTION IN AN EMERGENCY

If the green Ready light is flashing, press the On/Off button to turn on the FR3 and then follow all voice and text prompts. If the green Ready light is off and the FR3 is chirping, the FR3 may still be able to be used to treat a victim of SCA. Press the On/Off button and then follow all voice and text prompts.

In the unlikely event that the device becomes unresponsive during use, press the On/Off button once, wait one second, then press it again firmly. If this does not clear the problem, remove and reinstall the battery or replace it with a new FR3 battery, if available. If this still does not clear the problem, do not use the FR3.

If you are able to complete emergency use of the FR3, but cannot clear the problem as instructed on the status screen and the green Ready light is not flashing after the FR3 is put into standby, contact Philips at www.philips.com/AEDSupport for technical support.

NOTE: Perform CPR, if needed, any time there is delay before or an interruption in use of the FR3.

For detailed information about device behavior when it is not in use, consult the *Administrator's Reference CD-ROM* provided with the FR3 or contact Philips.

SAFETY CONSIDERATIONS

It is important to understand how to use your FR3 safely. In addition to the cautions provided throughout this guide, please review the safety considerations described in the following table. A **danger** describes an immediate hazard that will result in personal injury or death. A **warning** describes something that could cause serious personal injury or death. A **caution** describes something that could cause minor personal injury, damage to the FR3, loss of data stored in the defibrillator, or less chance of successful defibrillation.

DANGERS	
flammable gases	If the FR3 is used to give a shock in the presence of flammable anesthetics or concentrated oxygen, there is a risk of explosion. Move supplemental oxygen and oxygen delivery devices away from the defibrillation pads. However, it is safe to use the FR3 on someone wearing an oxygen mask.
hazardous electrical locations	The FR3 has not been evaluated or approved for use in hazardous locations as defined in the National Electrical Code (Articles 500-503). In accordance with the IEC Classifications (Section 5.5), the FR3 is not to be used in the presence of flammable substance/air mixtures.
battery	The 989803150161 and 989803150171 clinical use batteries are not rechargeable. Do not try to recharge, open, crush, or burn the battery, or it may explode or catch fire.
WARNINGS	
patient handling	Performing CPR or otherwise handling or moving the patient while the FR3 is analyzing the heart rhythm can cause an incorrect or delayed analysis. Under certain circumstances, this may result in a prompt to stop all movement so that the device can confirm rhythm analysis. Handling or transporting the patient during heart rhythm analysis can cause an incorrect or delayed analysis. If the FR3 gives a shock advised prompt, keep the patient as still as possible for at least 15 seconds so the FR3 can reconfirm the rhythm analysis before a shock is delivered.
battery	If battery leaks/vents, seek immediate medical attention for any physical contact/inhalation.
interference from RF devices	Radio-frequency (RF) interference from devices such as cellular phones, two-way radios, surgical equipment, electronic article surveillance equipment, and metal detectors can cause improper operation of the FR3. If the FR3 prompts that it cannot analyze, remove the FR3 from potential RF sources. Alternatively, move or turn off the RF source.
accessories	Using damaged or expired equipment or accessories may cause the defibrillator to perform improperly, and/or injure the victim or the user.

WARNINGS

defibrillator	<p>Use the FR3 only as described in this manual. Improper use of the FR3 can cause death or injury. Do not press the Shock button if the defibrillator pads are touching each other or are open and exposed.</p> <p>Defibrillation current can cause operator or bystander injury. Do not touch the patient during defibrillation.</p> <p>Disconnect the pads connector from the FR3 before using any other defibrillator.</p> <p>Before delivering a shock, it is important to disconnect the patient from other medical electrical equipment, such as blood-flow meters, that may not incorporate defibrillation protections. In addition, make sure the pads are not in contact with metal objects such as a bedframe or stretcher.</p> <p>For patient safety reasons, some very low-amplitude or low-frequency heart rhythms may not be interpreted by the FR3 as shockable VF rhythms. Also, some VT rhythms may not be interpreted as shockable rhythms.</p> <p>CPR rates significantly above 100 compressions per minute can cause incorrect or delayed analysis by the FR3. Under certain circumstances, this may result in a prompt to stop all motion so that the device can confirm rhythm analysis.</p>
pads	<p>Do not allow the defibrillator pads to touch each other or other ECG electrodes, lead wires, dressings, transdermal patches, or metal parts that are in contact with the patient such as a bedframe or stretcher. Such contact can cause electrical arcing and patient skin burns during defibrillation and may also divert the defibrillation current away from the heart.</p> <p>Prolonged or aggressive CPR to a patient with defibrillator pads attached can damage the pads. Replace the defibrillator pads if they are damaged during use or handling.</p> <p>Poor electrode pad-to-patient contact may result in a related defibrillator prompt or other indication. Check all electrical and patient connections.</p> <p>During defibrillation, air pockets between the skin and defibrillator pads can cause patient skin burns. To help prevent air pockets, make sure defibrillator pads completely adhere to the skin. Do not use dried out pads.</p>





CAUTIONS























fluids	Do not immerse any portion of the FR3 in water or other fluids. Do not let fluids get into the FR3. Avoid spilling any fluids on the FR3 or its accessories. Spilling fluids into the FR3 may damage it or cause a fire or shock hazard. Do not sterilize the FR3 or its accessories.
configuration	Alteration of the factory default setup of the FR3 can affect its performance and should be performed under the authorization of your Medical Director. Modifications to device operation resulting from changes to the default settings should be specifically covered in user training.
defibrillator	Hazardous electrical output. The FR3 is for use only by qualified personnel.
accessories	<p>The FR3 is designed to be used only with Philips-approved accessories. The FR3 may perform improperly if non-approved accessories are used.</p> <p>Use only Philips-approved FR3 data cards. The FR3 may record improperly if a non-approved data card is used. Install a blank FR3 data card after each use to avoid loss of data.</p>





CAUTIONS	
maintenance	<p>The FR3 was designed to be sturdy and reliable for many different field use conditions. However, excessively rough handling can result in damage to the FR3 or its accessories. Inspect the unit and accessories periodically according to instructions.</p> <p>Improper maintenance may damage the FR3 or cause it to function improperly. Maintain the FR3 according to directions.</p> <p>Electrical shock hazard. Dangerous high voltages and currents are present. Do not open the FR3, remove its covers, or attempt repair. There are no user-serviceable components in the FR3. The FR3 should be returned to Philips for repair.</p>
batteries	<p>Follow all instructions supplied with the FR3 batteries. For non-rechargeable FR3 batteries, install the battery before the “Install before” labeled date.</p> <p>Do not use the 861394 battery charger on aircraft.</p>
advanced use	<p>The FR3 advanced use mode’s manual charge feature is intended for use only by authorized operators who have been specifically trained in cardiac rhythm recognition and in defibrillation therapy using manual charge and shock delivery.</p>
monitoring	<p>The LCD screen on the FR3 model 861389 is intended only for basic ECG rhythm identification. The frequency response of the FR3 display is not intended to provide the resolution needed for diagnostic and ST segment interpretation.</p>
pads	<p>Follow all instructions supplied with the HeartStart defibrillator pads. Use the defibrillator pads before the expiration date shown on the package. Do not reuse the defibrillator pads. Discard them after use.</p> <p>Aggressive handling of the defibrillator pads in storage or prior to use can damage the pads. Discard the defibrillator pads if they become damaged.</p> <p>Do not place the pads directly over an implanted pacemaker or defibrillator. A noticeable lump with a surgical scar should indicate its position.</p>

SYMBOLS AND CONTROLS



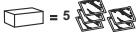
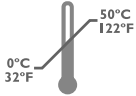

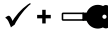

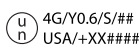

The following table explains the symbols and controls used on the FR3, its accessories, and their packaging.

REGULATORY MARKS AND GENERAL			
	Meets the requirements of the European medical device directives 93/42/EEC.		Meets the requirements of the applicable European directive.
	This product has passed relevant U.S. and Canadian safety tests by CSA, a Nationally Recognized Test Laboratory.		This product has been certified by the Australian Communication Authority.



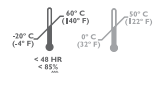

REGULATORY MARKS AND GENERAL	
 Authorized representative in the European Community.	 CAUTION: Federal law (USA) restricts this device to sale by or on the order of a physician.
 Printed on recycled paper.	 Refer to operating instructions.
 Protect from moisture.	 Handle with care.
 Manufacturer.	 Dispose of in accordance with your country's requirements.
 Reference order number.	 Serial number.
 Lot number.	 This product is disposable and is for single patient use only.
FR3 DEFIBRILLATOR	
 On/Off button (green). Turns the FR3 on or off; disarms the FR3, stops automatic self-test.	 Shock button (orange). Delivers shock to patient when the FR3 is charged.
 Option buttons (gray). When in Administration mode, press the appropriate option button, identified by a label on the FR3 display screen, to move around in or to select an item from a menu on the FR3 display screen. When in AED or advanced use mode, press the appropriate option button to enable device features relevant to the mode.	 Install the FR3 data card or FR3 language card in the direction shown.
 Insert the FR3 Infant/Child Key here.	 Defibrillation protection. Defibrillation protected, type BF patient connection.
 Risk of electrical shock.	 With battery installed, meets IEC 529 class IP55.
 This defibrillator uses the identified clinical battery.	 Do not use the FR3 in a magnetic resonance environment.

DEFIBRILLATOR AND TRAINING PADS	
 <p>Box contents = 5 pouches.</p>	 <p>Pouch contents: one pair of defibrillator pads.</p>
 <p>Store the pads at temperatures between 0° and 50° C (32° and 122° F).</p>	 <p>Non-sterile.</p>
 <p>This product does not contain natural rubber latex.</p>	 <p>Use these pads before the expiration date shown. Date format is MM-YYYY.</p>
 <p>Do not leave pads attached to patient for more than 24 hours.</p>	 <p>For use with Philips Heartstream/HeartStart and Laerdal HeartStart ForeRunner, FR, FR2, FR2+, FRx, and FR3 AEDs.</p>
 <p>Pads placement for adults.</p>	 <p>Pads placement for infants and children under 55 lbs (25 kg) or 8 years old.</p>
 <p>Do not use these pads with Laerdal Heartstart model 911, 1000, 2000, or 3000 AEDs.</p>	 <p>Do not use these pads with Philips Heartstart HSI model M5066A, M5067A, and M5068A AEDs.</p>
 <p>These pads may be used with the HeartStart FR3 on infants or children under 55 lbs (25 kg) or 8 years old in conjunction with the 989803150031 Infant/Child Key.</p>	 <p>These pads may be used with the HeartStart FRx on infants or children under 55 lbs (25 kg) or 8 years old in conjunction with the 989803139311 Infant/Child Key.</p>
BATTERIES	
 <p>Lithium manganese dioxide chemistry. 12 volts direct current output. 4.7 ampere hours. Contains < 7 grams lithium.</p>	 <p>Lithium ion battery chemistry. 10.8 volts direct current output. 4.5 ampere hours. < 50 watt hours. (2 strings of 3 series-connected, cylindrically shaped, lithium ion-cobalt cells connected in parallel, each 18 mm maximum diameter and 65 mm maximum overall height.)</p>
 <p>Contains one battery.</p>	 <p>This battery is for use with the HeartStart FR3 AED.</p>



BATTERIES











	<p>This packaging has been tested to United Nations standards and certified to be capable of protecting the lithium battery it contains.</p>		<p>Class 9 miscellaneous dangerous goods. (Symbol required on outer packaging by freight carrier regulations to identify shipments containing lithium batteries.)</p>
	<p>Do not crush.</p>		<p>Install battery before the date shown on this label in order to get the full specified battery life. Date format is YYYY-MM.</p>
	<p>Do not mutilate or open.</p>		<p>Environmental requirements for transportation and storage of the battery. Do not expose the battery to a relative humidity of more than 85% for more than 48 hours.</p>
	<p>Do not expose to high heat or open flames. Do not incinerate.</p>		<p>Storage requirements (refer to associated thermometer symbol).</p>
	<p>Transportation requirements (refer to associated thermometer symbol).</p>		<p>Dispose of the battery in accordance with your country's requirements.</p>

BATTERY CHARGER

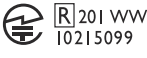
	<p>Electrical input.</p>		<p>Electrical output.</p>
	<p>For indoor use only.</p>		<p>Class II appliance with respect to protections against electric shock, per the requirements of IEC 60335-1.</p>
	<p>This product has passed relevant U.S. and Canadian safety tests by UL, Nationally Recognized Test Laboratory.</p>		

DATA CARD AND LANGUAGE CARD

	<p>FR3 data card.</p>		<p>FR3 language card.</p>
	<p>“Lockable” switch symbol on FR3 data card or FR3 language card. (The FR3 ignores this switch.)</p>		

FR3 INFANT/CHILD KEY	
	<p>Intended for use on patients under 8 years old or 55 lbs (25 kg).</p>
BLUETOOTH WIRELESS TECHNOLOGY MODULE	
	<p>Bluetooth wireless technology.</p>
	 <p>Be careful not to pinch finger when replacing wireless technology module compartment cover.</p>
	<p>This device has passed the radio frequency emission requirement for FCC Rule Parts 15C.</p>
	 <p>Interference could occur in the vicinity of equipment marked with this symbol.</p>
	<p>Complies with the Technical Regulations Conformity Certificate of Specified Radio equipment in Japan (ordinance of MPT No. 37, 1981)</p>
FR3 FAST RESPONSE KIT	
	<p>Pocket mask.</p>
	 <p>Non-latex gloves.</p>
	<p>Disposable razor.</p>
	 <p>Paramedics scissors.</p>
	<p>Absorbent wipe.</p>

NOTES

NOTES

PHILIPS

Philips Medical Systems is part of
Royal Philips Electronics

Philips Medical Systems

United States

Philips Medical Systems
2301 Fifth Avenue, Suite 200
Seattle, WA 98121-1825, USA
(800) 263-3342

Canada

Philips Healthcare, a Division of Philips Electronics Ltd.
281 Hillmount Road
Markham, Ontario
L6C 2S3 Canada
(800) 291-6743

Europe, Middle East, and Africa

Philips Medizin Systeme Boeblingen GmbH
Cardiac and Monitoring Systems
Hewlett-Packard Strasse 2
71034 Boeblingen, Germany
(+49) 7031 463-2254

Latin America

Philips Medical Systems Ltda.
Rua Verbo Divino - 1400 - 7o Andar
04719-002 São Paulo, Brazil
0800 7017789

Asia Pacific

Philips Electronics Hong Kong Ltd.
6/F, Core Building I
1 Science Park East Avenue
Hong Kong Science Park
Shatin, New Territories, Hong Kong
(852) 2821 5888

REF 989803150121



To Purchase, Visit Avobus.com or call [1-800-674-3655](tel:1-800-674-3655)