

DINAMAP® PRO Series 100-400 Monitor Operation Manual



CRITIKON
VITAL ANSWERS™



To Purchase, Visit Avobus.com or call [1-800-674-3655](tel:1-800-674-3655)

DINAMAP® PRO Monitor

Operation Manual

This manual is for DINAMAP® PRO Monitor Models 100, 200, 300, and 400, all with printers.

- PRO 100: BP and Pulse
- PRO 200: BP, Pulse, and Temp
- PRO 300: BP, Pulse, and SpO₂
- PRO 400: BP, Pulse, Temp, and SpO₂

The model of the Monitor determines which menu option buttons appear on the LCD. Please refer to applicable sections.

Reissues and Updates

Changes occurring between issues are addressed through Change Information Sheets, Addendums, and replacement pages. If a Change Information Sheet does not accompany this manual, it is correct as printed.

Errors and Omissions

If errors or omissions are found in this manual, please notify:

Critikon
Marketing Services
4502 Woodland Corporate Boulevard
Tampa, FL 33614
1-877-274-8456

Part No. 776995C

The content of this document including all figures and drawings is proprietary information of Critikon, provided solely for purposes of operation, maintenance or repair, and dissemination for other purposes or copying thereof is prohibited without prior written consent by Critikon, Tampa, Florida.

Illustrations may show design models; production units may incorporate changes.

Contents

Introduction	7
About the DINAMAP® PRO Monitor	7
Product Compliance	10
Symbols	11
Getting Started	13
Unpacking the Monitor and Accessories	13
Power Sources	13
Powering the Monitor	13
Rear Panel Connections	16
Front Panel Controls and Indicators	17
Switching the Monitor On and Off	19
Liquid Crystal Display (LCD)	19
Using the Printer	20
Installing the Paper	20
Printer Alarms	21
Storage	21
Using the Monitor	23
Noninvasive Blood Pressure Determination	23
Procedures	27
Manual Mode	29
Auto Mode	29
Stat Mode	30
Predictive Temperature Determination	31
Procedures	32
SpO ₂	34
Procedures	36
Troubleshooting	39
Using the Menu System	43
Introduction	43
Liquid Crystal Display	43
Rotor	46
Menu Tree	46
Main Menu	46
Vitals Button (UK: All Obs)	47
More... Button	48
Set BP Button (UK: BP Mode)	48
Alarms Button	49
Trend Button	51
Print Button	53
More... Menu	53
SpO ₂ Button (Models 300 and 400)	54
Config Button	54
Pwr Sav (Sleep Mode)	54
Time	55
Rotor	56
Display Button	56
Service Button	57
Clinician Menu	58
Error and Warning Messages	62
Alarms Button	62
Appendix A	63
Technical Specifications	63

BP	63
IVAC Temperature	63
SpO ₂	64
Mechanical	66
Power Requirements	66
Environmental	67
Appendix B	69
Patient Alarms	69
System Alarms	69
Failsafe Alarm	69
Hierarchy of Alarms	70
Appendix C	75
Principles of Noninvasive Blood Pressure Determination	75
Appendix D	79
Compatibility Table and Reorder Codes	79
Appendix E	81
Warranty, Service, and Spare Parts	81
Repairs	82
Packing Instructions	82
Service Manuals	82
Appendix F	83
Maintenance	83
Cleaning the Monitor	83
Cuff Cleaning and Disinfection	83
Temperature Devices	84
SpO ₂ Sensors	84
Storage and Battery Care	85
Fuses	86
Calibration	86
Leak Testing	86
Disposal of Product Waste	86
Appendix G	89
Connection Details	89
Host Port Connector (rear panel)	89

Introduction

About the DINAMAP® PRO Monitor

DINAMAP® PRO Monitors provide noninvasive determination of systolic blood pressure, diastolic blood pressure, mean arterial pressure, pulse rate, temperature, and oxygen saturation. These portable AC- and DC-operated monitors are primarily intended for use in hospital acute care settings such as outpatient surgery, accident and emergency, labor and delivery, GI/endoscopy, and medical/surgical units.

The PRO Monitor comes in four different models: PRO 100, 200, 300, and 400, all with printers.

- PRO 100: BP and Pulse
- PRO 200: BP, Pulse, and Temp
- PRO 300: BP, Pulse, and SpO₂
- PRO 400: BP, Pulse, Temp, and SpO₂

All of the main operations of the PRO Monitor are easy to use. Please review the factory default settings and, where applicable, enter settings appropriate for your use. The "Using the Monitor" section of this manual explains how to use the Monitor in its most simple form, while the "Using the Menu System" section explains how to customize measurements by using the menu system.

Indications

The PRO Monitor is intended to monitor one patient at the bedside.

Contraindications

This device is not designed, sold, or intended for use except as indicated.

Federal law (U.S.A.) restricts this device to sale by or on the order of a clinician.

Warnings

- **Do not use the PRO Monitor in the presence of magnetic resonance imaging (MRI) devices. There have been reports of sensors causing patient burns when operating in an MRI environment.**

- Do not use the Monitor in the presence of flammable anesthetics.
- To help prevent unintended current return paths with the use of high frequency (HF) surgical equipment, ensure that the HF surgical neutral electrode is properly connected.
- To avoid personal injury, do not perform any servicing unless qualified to do so.
- **WARNING:** These Monitors should not be used on patients who are connected to cardiopulmonary bypass machines.
- If powering the Monitor from an external power adapter or converter, use only Critikon-approved power adapters and converters.
- The Monitor does not include any user-replaceable fuses. Refer servicing to qualified service personnel.
- To reduce the risk of electric shock, do not remove the cover or the back. Refer servicing to a qualified service person.
- If the accuracy of any determination reading is questionable, first check the patient's vital signs by alternate means and then check the PRO Monitor for proper functioning.

Cautions

- Do not use replacement batteries other than the type supplied with the Monitor. Replacement batteries are available from Critikon. See Appendix D.
- The PRO Monitor is designed to conform to Electromagnetic Compatibility (EMC) standard IEC 601-1-2, 1993 and will operate accurately in conjunction with other medical equipment which also meets this requirement. To avoid interference problems affecting the Monitor, do not use the Monitor in the presence of equipment which does not conform to these specifications.

Introduction

- **Place the PRO Monitor on a rigid, secure surface. Monitor must only be used with mounting hardware, poles, and stands recommended by Critikon. See Appendix D.**
- **The weight of the accessory basket contents should not exceed 6.6 lb (3 kg).**
- **Arrange the power cord, air hoses, and all cables carefully so they do not constitute a hazard.**
- **Verify calibration of BP parameter (temp and pulse oximeter do not require calibration). Ensure that the display is functioning properly before operating the PRO Monitor.**
- **Do not immerse the Monitor in water. If the Monitor is splashed with water or becomes wet, wipe it immediately with a dry cloth.**
- **Do not gas sterilize or autoclave.**
- **The PRO Monitor, when used with Critikon-approved applied parts and accessories, is protected against defibrillator damage.**

Notes

- Waveforms may be distorted and readings inaccurate when electrosurgical cautery equipment is used while monitoring with the PRO Monitor.
- The electromagnetic compatibility profile of the PRO Monitor may change if accessories other than those specified for use with the PRO Monitor are used.
- Trend data are retained in the PRO Monitor when it is turned off, except when the default is overridden by selecting the Trend button under the Service menu.

Product Compliance

The DINAMAP® PRO Monitor is classified in the following categories for compliance with IEC 601-1:

- Class I, internally powered
- Transportable
- For continuous operation
- Not suitable for use in the presence of flammable anesthetics
- Not for use in the presence of an oxygen-enriched atmosphere (oxygen tent)
- Type BF applied parts
- IPX1, degree of protection against ingress of water
- Sterilization/Disinfection, see Appendix F



DINAMAP® PRO MONITOR

CLASSIFIED WITH RESPECT TO ELECTRIC SHOCK, FIRE AND MECHANICAL AND OTHER SPECIFIED HAZARDS ONLY IN ACCORDANCE WITH CAN/CSA C22.2 NO. 601.1. ALSO EVALUATED TO IEC-601-2-30.



This product conforms with the essential requirements of the Medical Device Directive. Accessories without the CE mark are not guaranteed to meet the Essential Requirements of the Medical Device Directive.

Getting Started

Unpacking the Monitor and Accessories

Before attempting to use the PRO Monitor, take a few minutes to become acquainted with the Monitor and its accessories. Unpack the items carefully, and check them against the contents checklist enclosed in one of the accessory boxes. This is also a good time to check for any damage or shortage. If there is a problem or shortage, contact Critikon.

It is recommended that all the packaging be retained, in case the Monitor must be returned for service in the future.

Power Sources

The PRO Monitor is designed to operate from either an internal lead-acid battery, AC mains or an IEC 601-1 compliant DC power source (see Appendix A). For replacement rechargeable batteries, please refer to the Service section of this manual.

The Monitor contains five fuses. Two AC line input fuses are mounted internally and are replaceable only by qualified service personnel. The remaining three fuses are auto-resettable and mounted within the Monitor. These fuses protect the low voltage DC input, the battery, and the +5 V output on the host port connector.

Powering the Monitor

Before the PRO Monitor is used for the first time, the battery should be charged in the Monitor for at least 8 hours.

Refer to the illustration of the rear panel connections. Looking at the rear of the PRO Monitor, remove the battery compartment cover. Insert the rechargeable battery into the compartment so that the battery terminals fit into the power clips at the bottom of the compartment. Then replace the cover. Insert the power cord plug into the mains external power socket (2) and plug into an AC outlet.

Refer to the illustration of the front panel controls and indicators. With mains or external DC power connected, the green external power indicator LED (14) will light to indicate that external power is being applied and that the battery is charging. If the battery is not inserted, the external

power indicator LED will flash (short flash approx. every 4 sec). When the Monitor is running on battery power, a battery icon appears in LCD area 3 (toggling with the time indicator) indicating the charge status.

During battery-only operation, the yellow battery power indicator LED (17) will light. When the battery becomes discharged beyond the low battery threshold, the indicator will begin to flash, and the Monitor will sound warning beeps every 30 seconds. At this point, the Monitor should be connected to an AC outlet to recharge the battery. If the Monitor continues to be used without charging the battery, the message **WARNING: THE BATTERY IS TOO LOW FOR MONITOR TO FUNCTION. TURN MONITOR OFF** appears. The Monitor shuts down all functions until it is turned off and the battery is recharged or replaced. To run the Monitor on AC power, it must be powered off and then on again.

Battery charging will take place as long as the Monitor remains connected to an external AC power source. A battery that is fully discharged can be fully recharged in 1 hour 50 minutes when the Monitor is switched off or 8 hours if the Monitor is switched on.

Notes

- To prolong the life of the battery, keep the Monitor connected to an AC outlet whenever possible. NEVER allow the battery to become completely discharged. A fully charged battery will power the Monitor for approximately 2 hours and should survive between 200 and 500 charge/discharge cycles. When it is necessary to replace the battery, refer to the "Compatibility Table and Reorder Codes" listed in Appendix D. To ensure full charge cycles, replace only with a recommended battery. If the Monitor is to be stored for some time, first charge the battery and then remove it and store it separately from the Monitor.
- For continued safety, use only a power cord of listed type SJT, three-conductor, min. No. 18 AWG, terminated in a medical/hospital grade attachment plug, provided with the following cord tag: "Hospital Grade Plug." Grounding

Getting Started

integrity can only be maintained when equipment is connected to an equivalent receptacle marked "Hospital Grade."

- Where the integrity of the external earth conductor in the installation or its arrangement is in doubt, the Monitor must be operated from its internal battery.

General Caution

- **Do not touch either the pin of the DC input connector (3) or the terminals within the battery compartment (1) and the patient at the same time.**

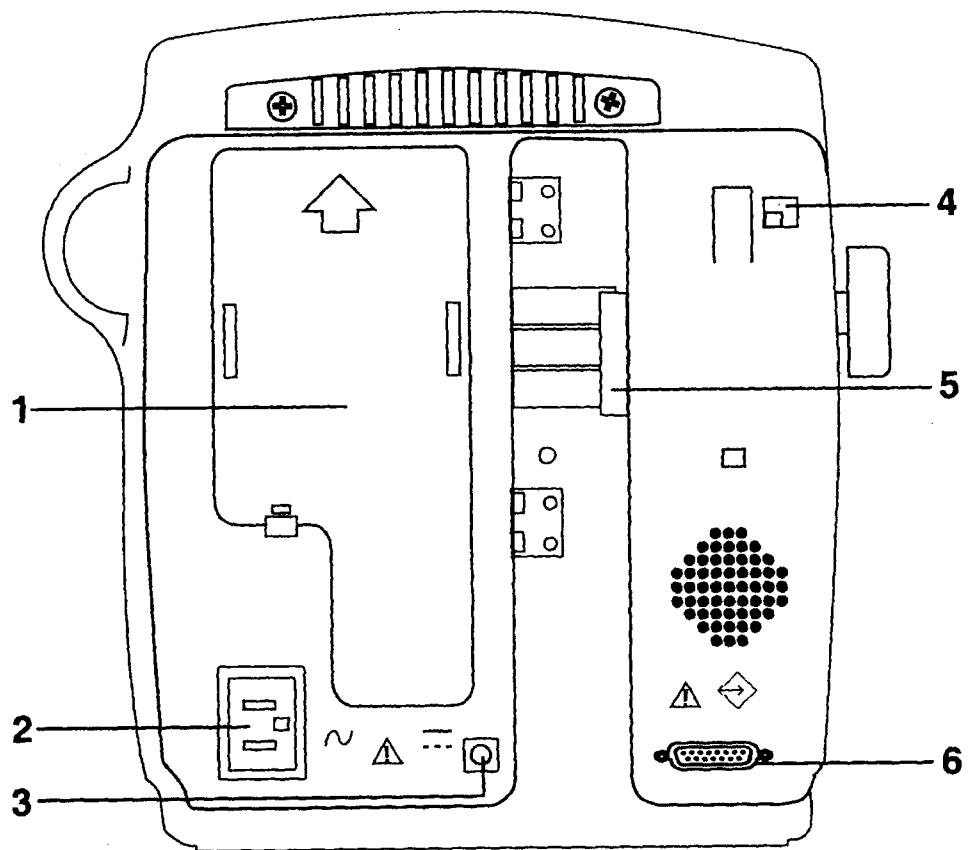

Rear Panel Connections

- 1 Battery compartment cover: Retains and protects internal battery
- 2 Mains input: Used to connect to AC power supply
- 3 External power socket: To be used with approved Critikon AC-DC power converter ONLY
- 4 Inactive temperature cable storage: Inactive temperature probe cable attaches here (Models 200 and 400)
- 5 Pole clamp: Used to clamp monitor to pole or stand
- 6 Data interface connector: Host communications port (15 way D-type RS-232 serial port) for use only with equipment conforming to IEC 601-1, configured to comply with IEC 601-1-1

Getting Started

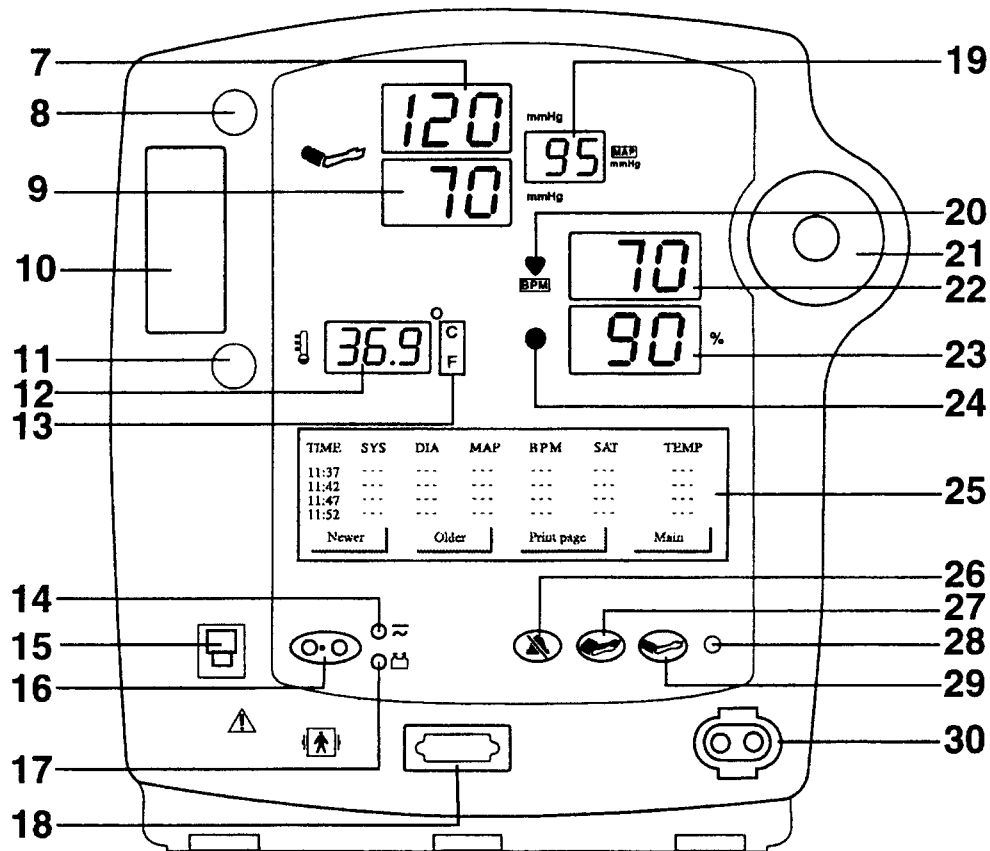

Front Panel Controls and Indicators

- 7 Systolic pressure display: 3-digit red LED indicates measured systolic BP in mmHg
- 8 Active temperature probe holster: Temperature probe that is being used stored here (Models 200 and 400)
- 9 Diastolic pressure display: 3-digit red LED indicates measured diastolic BP in mmHg
- 10 Temperature probe cover storage: Box of probe covers stored here (Models 200 and 400)
- 11 Inactive temperature probe holster: Extra temperature probe can be stored here (Models 200 and 400)
- 12 Temperature display: 4-digit red LED indicates measured temperature (Models 200 and 400)
- 13 °C °F display: Indicates whether temperature is being displayed in degrees Celsius or Fahrenheit (Models 200 and 400)

- 14** External power indicator: Green LED indicates external power status and battery charging status of monitor
- 15** Temperature probe connector: Temperature probe cable attaches here (Models 200 and 400)
- 16** ON/OFF switch: Controls on/off state of monitor; push for power on and push again for power off
- 17** Battery power indicator: Yellow LED indicates operation and charge status of internal battery
- 18** SpO₂ sensor connector: SpO₂ sensor extension cable attaches here (Models 300 and 400)
- 19** Mean arterial pressure display: 3-digit red LED indicates measured MAP in mmHg and shows instantaneous cuff pressure during BP determination
- 20** SpO₂ pulse indicator: Yellow LED in heart symbol flashes to indicate that real-time pulse rate measurements are being derived from SpO₂ signals (Models 300 and 400)
- 21** Rotor: Used to highlight and select items in LCD menus; if monitor is off, pressing rotor will switch monitor on
- 22** Pulse BPM display: 3-digit yellow LED shows pulse rate in beats per minute
- 23** SpO₂ display: 3-digit red LED indicates oxygen saturation in % (Models 300 and 400)
- 24** SpO₂ artifact indicator LED: Illuminates when motion artifact is detected (Models 300 and 400)
- 25** LCD (liquid crystal display): Displays all alarms, user interface messages, and configuration options
- 26** Alarm silence switch: Alternately mutes and enables audible alarms; when pushed once after alarm sounds (silence on), switch lights to indicate that audible alarms have been silenced for 2 minutes
- 27** AUTO BP key: Press to start Auto BP mode
- 28** Light sensor: Automatically measures ambient light to set LED display intensity
- 29** START/STOP BP key: Press to start or stop a BP, Auto, Stat, or Vitals determination
- 30** Cuff connector: BP cuff hose attaches here

Getting Started

Switching the Monitor On and Off



To switch the DINAMAP PRO Monitor on, push the power ON/OFF switch (16) or press the rotor (21).

As the Monitor powers up, it will run a short self-test routine, which will flash all the indicator lights and then beep the warning speaker. After a few seconds the system will be ready for operation, as indicated by the appearance of the main menu on the LCD (25).

To switch the Monitor off, push the power ON/OFF switch (16) again. This will terminate any measurements that may be in progress and automatically deflate the cuff.

When the Monitor is operating on the internal battery only, battery life is enhanced by the use of the sleep mode. However, the PRO Monitor will not enter sleep mode if an alarm is active. If no controls are used and no determinations are being made, the Monitor will enter sleep mode after a time which can be preset by the operator. All LED displays will be blanked except for a dash in the far-left systolic position, and any existing readings will be transferred to the LCD, which displays the message "Sleep Mode Active." Moving the rotor or pressing a key will "wake up" the Monitor.

Liquid Crystal Display (LCD)

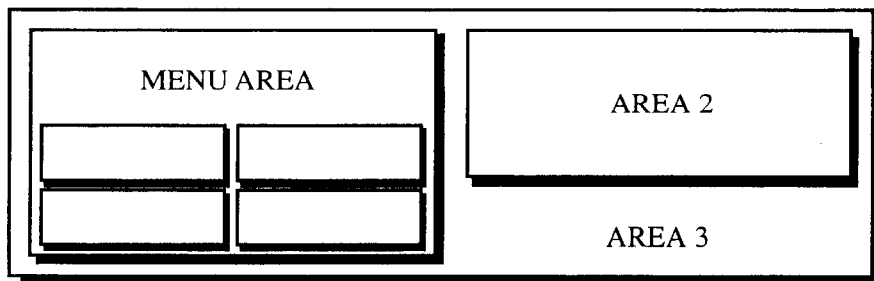

Menu Area

This area displays the name of the menu that has option buttons available for selection. Normal text in the menu area appears dark on a light background, while the text of

selected buttons appears light on a dark background.

Note: Some menus have six option buttons. In these cases, there is no space available to display the menu title.

Area 2

This area displays data from one of three different sources.

- Source 1: SpO₂ plethysmograph (Models 300 and 400)
- Source 2: Last three BP readings
- Source 3: Error and warning messages

Note: Refer to "Display Button" in the "Using the Menu System" section for instructions on setting Area 2.

Area 3

This area displays the time, the time lapsed since the last Auto BP determination (if in Auto BP mode), the battery icon (if operating on battery power, the time and battery icon toggle), and the BP and Printer modes.

Using the Printer

Installing the Paper

Turn the PRO Monitor so that the side is facing you. While grasping the side of the Monitor, firmly press the notched indentations on the printer door to open it. The printer door will pop open. With the Monitor powered on, place the roll of paper into the compartment so that the end of the paper comes off the top, and thread it between the two printer plates. As the paper touches the plates, the paper will begin to auto-feed itself into the printer. Feeding the end of the paper strip through the slot in the door, firmly press the notched indentation on the side of the printer door to close it. Use the paper release lever to clear a paper jam or manually feed the paper.

Note: Make sure that the roll of paper is tightly wound.

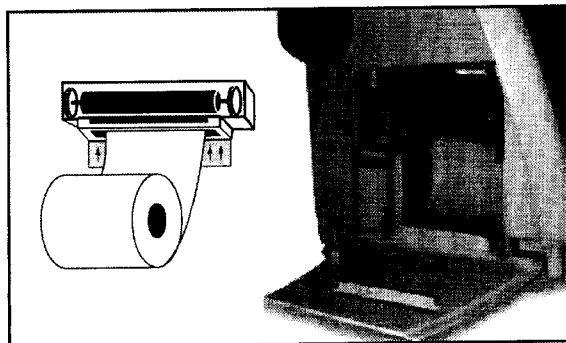

Getting Started

Any time the paper is loaded, the printer automatically prints a test strip with the DINAMAP® PRO name on it. If no print is visible on the paper, check that the paper roll has been installed in the correct position (refer to diagram). To tear off the printout, use a slight sideways action to pull the paper sharply up across the serrated edge of the door.

Printer Alarms

If the Monitor is switched on with no paper installed or with the printer door open, the message "No Paper" will appear next to "PRNT" in Area 3 of the LCD. When new paper is installed and the printer door is closed, the message will change to "Manual" for Manual print or "Auto" for Auto print, depending on the status before the paper change.

If the paper runs out during a print request or if an attempt is made to print when no paper is installed, the message "Printer - No Paper" will appear in Area 2 of the LCD and an audible alarm will sound. In addition, the message "No Paper" will appear next to "PRNT" in Area 3 of the LCD. To clear the alarm, press the rotor. The message in Area 3 of the LCD will remain until new paper is installed and the printer door is closed. (See "Using the Menu System.")

Installing new paper will cause the Critikon DINAMAP PRO header to be printed, thereby confirming that the paper is installed correctly and that the printer is operational. The message next to "PRNT" in Area 3 of the LCD will change to "Auto" or "Manual" to identify the operating mode of the printer. After power-off, the operating mode of the printer returns to the previous user-selected setting (Auto or Manual) unless specified otherwise in the Print button under the Service Button.

Storage

Store thermal paper in a cool, dry place. The printed strip (thermal paper recording) should not be

- exposed to direct sunlight,
- exposed to temperatures over 100 °F/38 °C or relative humidity over 80%, or
- placed in contact with adhesives, adhesive tapes, or plasticizers such as those found in all PVC page protectors.

Note: When in doubt about long-term storage conditions, store a photocopy of the thermal paper recording.

Cautions

- **The paper is thermally activated; therefore, do not store it in a hot place as discoloration may result.**
- **Use only replacement paper rolls (58 mm) from Critikon.**

Using the Monitor

Noninvasive Blood Pressure Determination

Description

The BP parameter is included in Models 100, 200, 300, and 400. Blood pressure is monitored noninvasively in the PRO Monitor by the oscillometric method, which measures the amplitude of the pressure oscillations within the blood pressure cuff. Further information about the oscillometric method is in Appendix C.

The PRO Monitor has four BP modes: 1. Manual, 2. Auto, 3. Stat, and 4. Vitals (UK: All Obs). The mode, which is selected by the user, is shown on the LCD (25). The BP measurements are automatic, and once the cycle is complete the LED displays (7, 9, 19, 22) show systolic pressure, diastolic pressure, mean arterial pressure, and pulse rate.

1. Manual BP determinations are started by pressing the START/STOP BP key (29). In the Manual mode, the blood pressure is determined one time.
2. Auto BP determinations are started by selecting the AUTO BP key (27) or the Auto button under the Set BP (UK: BP Mode) button in the Main menu.

When Auto mode is selected, a number at the right of the Auto button indicates the time interval between each reading. To change the time interval, choose the box around the number and turn the rotor until the desired interval is reached. The interval can be set between 1 and 120 minutes (1, 2, 3, 4, 5, 10, 15, 20, 25, 30, 45, 60, 90, and 120 minutes). Press the rotor to confirm the setting.

3. Stat determinations are started by selecting the Stat button under the Set BP button (UK: BP Mode) in the Main menu. In the Stat mode, the blood pressure is determined as many times as possible in 5 minutes.
4. Vitals (UK: All Obs) determinations are started by selecting the Vitals (UK: All Obs) button in the Main menu. (Refer to the "Using the Menu System" section.) Selection of this button initiates a BP determination

while allowing SpO₂ and predictive temperature determinations to be monitored and recorded (depending on Monitor model). In the Vitals (UK: All Obs) mode, the blood pressure is determined one time.

Before each BP determination, the Monitor performs a test to ensure that the cuff pressure is below a specified level. The determination is delayed until this condition is met. During the delay, the BP values are displayed as zero.

The Monitor senses the type of hose being used and automatically uses adult/pediatric monitoring parameters or neonatal monitoring parameters, as appropriate.

Audible and visible alarms occur when a value for systolic pressure, diastolic pressure, mean arterial pressure, or pulse rate is outside the selected high or low limit.

Instructions for cleaning and disinfecting BP cuffs are in Appendix F.

General Warnings

- **The PRO Monitor will not measure blood pressure effectively on patients who are experiencing seizures or tremors.**
- **Arrhythmias will increase the time required by the PRO Monitor to determine a blood pressure and may extend the time beyond the capabilities of the Monitor.**
- **In Manual mode, the PRO Monitor displays the results of the last blood pressure determination for 2 minutes or until another determination is completed. If a patient's condition changes between one determination and the next, the Monitor will not detect the change or indicate an alarm condition.**
- **Devices that exert pressure on tissue have been associated with purpura, skin avulsion, compartmental syndrome, ischemia and/or neuropathy. To minimize these potential problems, especially when monitoring at frequent intervals or over extended periods of time, make sure the cuff is applied appropriately and**

Using the Monitor

examine the cuff site and the limb distal to the cuff regularly for signs of impeded blood flow.

- Do not apply external pressure against cuff while monitoring. Doing so may cause inaccurate blood pressure values.
- Use care when placing cuff on extremity used to monitor other patient parameters.
- The PRO Monitor is designed for use only with dual-tube cuffs.
- Use only accessories recommended by Critikon. Failure to use recommended accessories may result in inaccurate readings. See Appendix D.
- Blood pressure cuffs should be removed from the patient when the Monitor is powered off. If the extremity remains cuffed under these conditions or if the interval between blood pressure determinations is prolonged, the patient's limb should be observed frequently and the cuff placement site should be rotated as needed.

General Cautions

- Accuracy of BP measurement depends on using a cuff of the proper size. It is essential to measure the circumference of the limb and to select the proper size cuff. The air hoses are color-coded according to size of the patient. The gray 12- or 24-foot hose (3.66 m or 7.3 m) is required on patients who require cuff sizes from infant through thigh cuffs. The teal (blue-green) 12-foot hose (3.66 m) is required for the neonatal cuff sizes #1 through #5.
- If it becomes necessary to move the cuff to another limb, make sure the appropriate size cuff is used.
- The pulse rate derived from a BP determination may differ from the heart rate derived from an EKG waveform because the PRO Monitor measures actual peripheral pulses, not electrical signals or contractions from the heart. Differences may occur because electrical signals at the heart occasionally fail

to produce a peripheral pulse or the patient may have poor peripheral perfusion. Also, if a patient's beat-to-beat pulse amplitude varies significantly (e.g., because of pulsus alternans, atrial fibrillation, or the use of a rapid-cycling artificial ventilator), blood pressure and pulse rate readings can be erratic, and an alternate measuring method should be used for confirmation.

General Notes

- A patient's vital signs may vary dramatically during the use of cardiovascular agents such as those that raise or lower blood pressure or those that increase or decrease heart rate.
- Because treatment protocols based on the patient's blood pressure may rely on specific values and differing measurement methods, such as auscultatory, clinicians should note a possible variance from values obtained with the PRO Monitor in planning patient care management. The PRO Monitor values are based on the oscillometric method of noninvasive blood pressure measurement and correspond to comparisons with intra-aortic values within ANSI /AAMI Standards for accuracy (a mean difference of ± 5 mmHg, and a standard deviation of ± 8 mmHg).
- Several conditions may cause the BP parameter to calculate and display only the mean arterial pressure (MAP) without a systolic and diastolic reading. These conditions include very low systolic and amplitude fluctuations, so an accurate calculation for these values can't be made (e.g., patient in shock); too small of a difference between systolic and MAP calculations in relationship to the difference between diastolic and MAP; or a leak has occurred in the PRO Monitor (1. Check all BP connections 2. Monitor may need calibration and leak testing). If only the MAP value is displayed, the systolic and diastolic will display dashes (—) and an alarm message "N99-BP FAILED" will be displayed.

Using the Monitor

Procedures

1. Connect the end of the air hose which has quick-release clips to the cuff connector (30) on the front of the Monitor. Make sure that the hose is not kinked or compressed.

Note: To disconnect the hose from the Monitor, squeeze the quick-release clips together and pull the plug from the cuff connector (30).

2. Select the appropriate blood pressure measurement site. Because normative values are generally based on this site and as a matter of convenience, the upper arm is preferred. When upper arm size or shape, the patient's clinical condition, or other factors prohibit use of the upper arm, the clinician must plan patient care accordingly, taking into account the patient's cardiovascular status and the effect of an alternative site on blood pressure values, proper cuff size, and comfort. The figure shows the recommended sites for placing cuffs.

Warning: Do not place the cuff on a limb being used for intravenous infusion or any area where circulation is compromised or has the potential to be compromised.

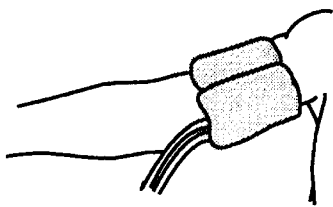

Adult/Pediatric

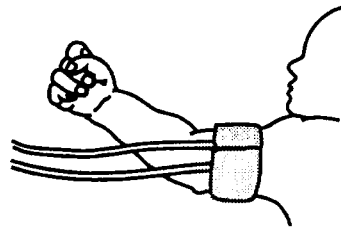

Neonate

3. If patient is standing, sitting, or inclined, ensure that cuffed limb is supported to maintain cuff at level of patient's heart. If cuff is not at heart level, the difference in systolic and diastolic values due to hydrostatic effect must be considered. Add 1.80 mmHg to values for every inch (2.54 cm) above heart level. Subtract 1.80 mmHg from values for every inch (2.54 cm) below heart level.
4. Select appropriate cuff size. Measure patient's limb and select appropriately sized cuff according to size marked on cuff or cuff packaging. When cuff sizes overlap for a specified circumference, choose the larger size cuff.

Precaution: Accuracy depends on use of proper size cuff.

5. **Inspect cuff for damage. Replace cuff when aging, tearing, or weak closure is apparent. Do not inflate cuff when unwrapped.**
Precaution: Do not use cuff if structural integrity is suspect.
6. Connect the cuff to the air hose. Thread the cuff connectors onto the hose connectors until finger tight. Do not overtighten.
Warning: It is mandatory that the appropriate hose and cuff combination be used. Any attempt to modify the hose will inhibit the Monitor from switching between the neonatal and adult measurement modes.
Note: In normal use, each cuff will have its own hose, so it will not usually be necessary to disconnect them. If it is necessary to do so, carefully unscrew the cuff from the hose. Care should be taken in reconnecting the cuff to a hose, ensuring that threads of the cuff and hose are in alignment and no cross-threading occurs.
7. Inspect patient's limb prior to application.
Precaution: Do not apply cuff to areas where skin is not intact or tissue is injured.
8. Palpate artery and place cuff so that patient's artery is aligned with cuff arrow marked "artery."
9. Squeeze all air from cuff and confirm that connection is secure and unoccluded and that tubing is not kinked.
10. Wrap cuff snugly around the patient's limb. Cuff index line must fall within the range markings. Ensure that hook and loop closures are properly engaged so that pressure is evenly distributed throughout cuff. If upper arm is used, place cuff as far proximally as possible.
11. Proper cuff wrapping should be snug, but should still allow space for a finger between patient and cuff. Cuff should not be so tight as to prevent venous return between determinations.
Warning: Using a cuff that is too tight will cause venous congestion and discoloration of the limb, but using a cuff that is too loose may result in no readings and/or inaccurate readings.
12. Proceed with monitoring in the Manual, Auto, Stat, or Vitals (UK: All Obs) mode.

Using the Monitor

Manual Mode



To start a determination, press the START/STOP BP key (29). A normal, uninterrupted Manual cycle takes about 40 seconds. The cuff pressure must drop below 5 mmHg (neonate) or 15 mmHg (adult) before another determination can be started. BP information will be displayed for 2 minutes on the LED unless another determination is started within that time frame. This applies to Manual and Vitals (UK: All Obs) modes. After power-off, the operating mode returns to the default setting of Manual. The default setting of Manual can be overridden to return to the previous user-selected setting (Auto or Manual) by selecting Set BP (UK: BP Mode) under the Service menu.

Note: The START/STOP BP key is an on-off switch; pressing it will stop any BP determination (Manual, Auto, Stat, or Vitals) that is in progress.

Auto Mode



Auto BP determinations are started by selecting the AUTO BP key (27) or the Auto button under the Set BP button (UK: BP Mode) in the Main menu.

Selecting the AUTO BP key (27) brings up the Set BP menu (UK: BP Mode) and automatically starts an Auto BP determination as long as the Monitor is in Manual BP mode. If the Monitor is already in Auto BP mode, selection of the AUTO BP key (27) brings up the Set BP menu (UK: BP Mode) without starting a new determination until the preset time interval has expired. Pressing the START/STOP BP key during a series of Auto BP determinations will cancel the determination in progress.

When Auto mode is selected, a number at the right of the Auto button indicates the time interval between each reading. To change the time interval, choose the box around the number and turn the rotor until the desired interval is reached. The interval can be set between 1 and 120 minutes (1, 2, 3, 4, 5, 10, 15, 20, 25, 30, 45, 60, 90, and

120 minutes). Press the rotor to confirm the setting. After power-off, the operating mode returns to the default setting of Manual. The default setting of Manual can be overridden to return to the previous user-selected setting (Auto or Manual) by selecting Set BP (UK: BP Mode) under the Service menu.

In the Auto mode, the pressure must be below 5 mmHg (neonate) or 15 mmHg (adult) for at least 30 seconds before another determination can be started. BP information will be displayed on the LED until the next determination is started. This applies to Auto mode only.

Note: To cancel an Auto BP determination, select the Manual button in the Set BP menu (UK: BP Mode).

Stat Mode

Multiple BP readings can be taken at any time by selecting the Stat button under the Set BP button (UK: BP Mode) in the Main menu. Stat mode can also be accessed by pressing the AUTO BP key (27) and then selecting the Stat button when the Set BP menu (UK: BP Mode) appears.

If a Manual determination is not in progress, a 5-minute series of determinations will start. If a Manual determination is in progress, that determination will become the first in the series. A normal, uninterrupted Stat sequence will give the first set of systolic, diastolic, and mean arterial pressure values and pulse rate within 15 to 20 seconds. Selecting the Stat button during a series of Stat determinations will cancel the determination in progress and the rest of the series. BP information will be displayed on the LED until the determination has been canceled or completed. This applies to Stat mode only.

The series begins with cuff inflation to a pressure above the previous systolic pressure or, if no previous systolic value is stored, to approximately 160 mmHg for adult/pediatrics. The initial target pressure selection for neonates is 110 mmHg. Artifact rejection is relaxed in the Stat mode for adult/pediatric patients to allow for accelerated determinations. If a BP or Stat reading has been made previously, the first new systolic value will flash on the LED display (7) within a few seconds and will continue to flash until the end of the determination. At that point a short tone will sound and the updated systolic, diastolic, and mean

Using the Monitor

arterial pressures and pulse rate will appear on their LED displays (7, 9, 19, 22). The Monitor will begin another determination once the pressure is below 5 mmHg for 8 seconds (neonates) or 15 mmHg for 4 seconds (adults), unless the 5-minute period has ended or the determination has been canceled.

Note: Alarm limits are disabled while in Stat mode.

Predictive Temperature Determination



Description

The temperature parameter is included in Models 200 and 400. The PRO Monitor uses IVAC* technology and can be used with both oral and rectal temperature probes. Two modes of operation are available: predictive and monitor. In predictive mode, a final temperature is displayed with an audible tone. In monitor mode, the display is updated continually as the patient's temperature rises or falls.

Note: If the PRO is unable to complete a predictive determination, then it enters monitor mode. These temperature readings are not stored in trends and not reported via host comms.

During a temperature determination, the temperature display (12) provides a progress meter and probe ready indicator. In the far-left position, a single horizontal line indicates the probe is ready to start a determination after removal from the probe holster. In the far-right position of the temperature display, a "chase sequence" around the outside space indicates a predictive temperature determination is in progress. During monitor mode, the temperature readings flash constantly.

Temperature is shown on the temperature display in degrees Celsius or Fahrenheit, and the unit of measure is indicated by the °C °F display (13). The default, which is Celsius, can be changed in the Clinician Menu (please refer to the "Using the Menu System" section of this manual).

*IVAC is a trademark of Alaris Medical Systems

General Warning

- The performance of the Monitor may be degraded if it is operated outside of the environmental conditions specified in Appendix A.

General Cautions

- Be careful not to overextend the coiled cord of the temperature probe. Overextension can damage the probe coil connector interfaces.
- Accurate oral temperatures (blue) can only be obtained by placing the probe under the tongue in the right or left sublingual pocket. Temperatures in other locations in the mouth can vary by more than 2 °F or 1 °C.
- Accurate rectal temperatures can only be obtained by using the red temperature probe. Red and blue temperature probes are *not* interchangeable.
- Do not allow the tip of the predictive temperature probe to come into contact with a heat source (e.g., hands or fingers) prior to taking a temperature determination. If this occurs, allow 5 seconds for the probe tip to cool before proceeding.
- Use only IVAC* probes and probe covers. The size, shape, and thermal characteristics of the probe covers can affect the performance of the instrument. Inaccurate readings or retention problems may occur unless IVAC probes and probe covers are used.

Procedures

1. Connect the temperature probe cable to the temperature probe connector (15).
2. Remove the temperature probe from the probe holster. Place a protective temperature probe cover on the probe and insert the probe appropriately.
3. The determination begins automatically. Hold the temperature probe steady until the determination is complete. This takes approximately 60 seconds, during which time a pattern of lines on the temperature display (12) appears as a “chase sequence” to indicate progress.

*IVAC is a trademark of Alaris Medical Systems

Using the Monitor

When the determination is complete, an audible tone sounds and the temperature appears on the display.

4. Record the temperature and remove the probe. Discard the disposable cover by holding the probe as you would a syringe and pressing the button on the probe handle. Place the probe in the probe holster. Once you place the probe in the probe holster, the temperature values will be cleared.

Notes

- If the probe tip temperature is 94.0° F or higher (34.4° C) when taken out of the probe holster, the thermometer will not be able to perform a predictive measurement. Instead, the thermometer will automatically go into monitor mode. The temperature reading will then flash. A correct final temperature reading may require 3 minutes or longer. The Monitor will not beep at final temperature. It will continue to monitor the patient's temperature until the probe is removed from the patient and returned to the probe holster.
- To cool the temperature probe down, wipe with alcohol.
- If there is a long delay from the time the probe is removed from the probe holster until it is inserted into the patient's mouth, it is possible that the instrument will not display a final temperature. If this occurs, insert the probe into the probe holster, remove it again, and start a new measurement.
- If an alarm is actively sounding, an audible tone will not sound.
- If tissue contact is lost, the chase sequence on the temperature display (12) stops. If tissue contact is not made within 1 minute, the Monitor will alarm.

SpO₂

Description

The SpO₂ parameter is included in Models 300 and 400. To begin SpO₂ monitoring, simply place the SpO₂ sensor on the patient's finger; monitoring begins automatically. Functional oxygen saturation (SpO₂) of arterial blood is noninvasively and continuously monitored in the PRO Monitor using pulse oximetry technology from NELLCOR*. Functional SpO₂ is the ratio of oxygenated hemoglobin to hemoglobin that is capable of transporting oxygen. This ratio, expressed as a percentage, is shown on the SpO₂ display (23), which is continually updated.

Heart rate derived from SpO₂ appears in the Pulse BPM display (22), and the SpO₂ pulse indicator (20) flashes synchronization with the real-time pulse rate measurements that are derived from the SpO₂ signal. A tone sounds at a rate corresponding to the pulse rate and at a pitch corresponding to the SpO₂ saturation level. The pitch is highest at 100% oxygen saturation, and it becomes lower as the saturation level falls. The Monitor can display a pulse amplitude bar and a plethysmographic waveform on the LCD (25). The pulse amplitude bar graph is proportional to the arterial blood flow. The artifact indicator LED (24) lights continuously when the Monitor detects motion sufficient enough to affect readings.

Audible and visible alarms occur when SpO₂ levels are outside the alarm limits. When a limit alarm occurs, a message appears in Area 2 of the LCD display.

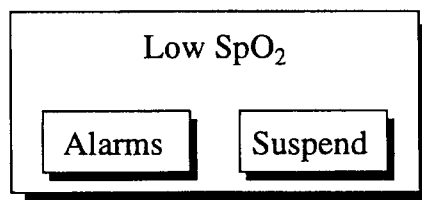

If you select the Alarms button, the Alarms menu appears. This menu is used to adjust the violation limits for BP and SpO₂. Refer to "Alarms Button" in the "Using the Menu System" section.

*NELLCOR is a trademark of Mallinckrodt, Inc.

Using the Monitor

If you select the Suspend button, the SpO₂ alarm is suspended for 2 minutes and then the PRO returns to normal SpO₂ monitoring. A message informing the user that SpO₂ is suspending appears in Area 2 and dashes appear in the SpO₂ LED while the SpO₂ alarm suspend is counting down. Selecting **Cancel** will cancel the SpO₂ alarm suspension and return to monitoring SpO₂.

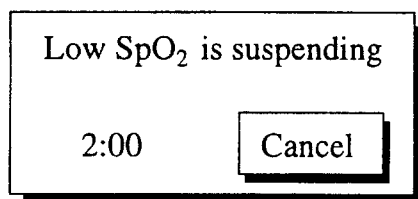

If the Monitor is unable to detect a pulse for 10 seconds during normal SpO₂ monitoring, the values in the LED flash, alternating patient values with dashes. The Monitor returns to normal SpO₂ reporting of values when several consecutive good pulse determinations are made.

General Warnings

- **Do not use the SpO₂ function during magnetic resonance imaging (MRI). Adverse reactions include potential burns to patients as a result of contact with attachments heated by the MRI radio frequency pulse, potential degradation of the magnetic resonance image, and potential reduced accuracy of SpO₂ measurements. Always remove oximetry devices and attachments from the MRI environment before scanning a patient.**
- **The use of cardio-green and other intravascular dyes at certain concentrations may affect the accuracy of the SpO₂ measurement.**
- **The SpO₂ function is calibrated to read functional arterial oxygen saturation. Significant levels of dysfunctional hemoglobins such as carboxyhemoglobin or methemoglobin may affect the accuracy of the SpO₂ measurement.**

General Cautions

- **As with any clip-on sensor, pressure is exerted. The clinician should be cautious in using a clip-on sensor on**

patients with compromised circulation (e.g., because of peripheral vascular disease or vasoconstricting medications).

- Do not perform any testing or maintenance on a sensor while it is being used to monitor a patient.
- Bright light sources (e.g., infrared heat lamps, bilirubin lights, direct sunlight, operating room lights) may interfere with the performance of the SpO₂ function. To prevent such interference, cover the sensor with opaque material.

General Notes

- A patient's vital signs may vary dramatically during the use of cardiovascular agents such as those that raise or lower blood pressure or those that increase or decrease heart rate.
- The PRO Monitor is compatible only with NELLCOR sensors.
- Software development, software validation, and Risk and Hazard Analysis has been performed to a registered quality system.

Procedures

1. Select a sensor that is appropriate for the patient and the clinical situation.

Warning: Do not use a damaged sensor or one with exposed electrical contacts.

Note: Use only NELLCOR sensors, which are available from:

USA Mallinckrodt, Inc.
675 MacDonnell Blvd
PO Box 5840
St. Louis, MO 63134
Phone: 1-800-NELLCOR (USA) Fax: 1-888-222-9799

UK Nellcor
10 Talisman Business Center
London Road
Bicester
Oxfordshire OX6-OJX
UK
Phone: 44-189-632-2700

Using the Monitor

2. Following the directions for use supplied with the sensor, apply the sensor to the patient.

Warnings

Patient safety:

- If you fail to apply the sensor properly, the patient's skin could be injured or the ability of the PRO Monitor to measure oxygen saturation could be compromised. For example, a clip-on sensor should never be taped shut. Taping the sensor could damage the patient's skin or impair the venous return, thus causing venous pulsation and inaccurate measurement of oxygen saturation.
- Excessive pressure from the sensor may cause necrosis of the skin.

Monitor performance:

- When an SpO₂ sensor is on a limb that has a blood pressure cuff, the SpO₂ data will not be valid when the cuff is inflated. If SpO₂ readings are required during the entire blood pressure determination, attach the SpO₂ sensor to the limb opposite the one with the blood pressure cuff.
- Remove nail polish and artificial nails. Placing a sensor on a polished or an artificial nail may affect accuracy.

Cautions

Patient safety:

- Do not place any clip-on sensor in a patient's mouth or on a patient's nose or toe.
- Do not place a clip-on finger sensor on a patient's thumb or across a child's foot or hand.
- Observe the sensor site to assure adequate distal circulation.

Monitor performance:

- For best performance, place the sensor at heart level.
- Placing a sensor distal to an arterial line may interfere with adequate arterial pulsation and compromise the measurement of SpO₂.

- **Place the sensor so that the LEDs and the photodiode are opposite each other.**
- 3. Plug the SpO₂ sensor into the SpO₂ sensor extension cable. Then plug the SpO₂ sensor extension cable into the SpO₂ sensor connector (18).
- 4. Proceed with monitoring. SpO₂ determinations run continuously and can run simultaneously with other measurements.

Using the Monitor

Troubleshooting

This section discusses potential difficulties and suggestions for resolving them. If the difficulty persists, contact a qualified service person or your local Critikon representative.

The service manual, which is for use by qualified service personnel provides additional troubleshooting information.

PROBLEM: The pulse amplitude bar indicates a pulse, but no oxygen saturation or pulse rate values appear on the screen.

CAUSE:

- Excessive patient motion may be making it impossible for the SpO₂ function to find a pulse pattern.
- The sensor may be damaged.
- The patient's perfusion may be too low to allow the SpO₂ function to measure saturation and pulse rate.

SOLUTION:

Check the patient.

- If possible, keep the patient still; check whether the SpO₂ sensor is applied securely and properly, and replace it if necessary; move the sensor to a new site; or use a disposable adhesive sensor that may tolerate more motion.
- Replace the sensor.

PROBLEM: The SpO₂ value or the pulse rate changes rapidly; the pulse amplitude bar is erratic.

CAUSE:

- Excessive patient motion may be making it impossible for the SpO₂ function to find a pulse pattern.
- An electrosurgical unit (ESU) may be interfering with performance.

SOLUTION:

Check the patient.

- If possible, keep the patient still; check whether the sensor is applied securely and properly, and replace it if necessary; move the sensor to a new site; use a sensor that tolerates more motion.

If an ESU is interfering:

- Move the SpO₂ cable as far from the ESU as possible.
- Plug the Monitor and the ESU into different AC circuits.
- Move the ESU ground pad as close to the surgical site as possible.
- The sensor may be damp or may need to be replaced with a new sensor.
- If the patient weighs less than 3 kg or more than 40 kg, apply an OXISENSOR N-25 oxygen transducer to an appropriate site. This sensor has added protection against electrosurgical interference.

PROBLEM: The oxygen saturation measurement does not correlate with the value calculated from a blood gas determination.

CAUSE:

- The SpO₂ calculation may not have correctly adjusted for the effects of pH; temperature; CO₂; fetal hemoglobin; or 2,3-DPG.
- Accuracy can be affected by incorrect sensor application or use; intravascular dyes; bright light; excessive patient movement; venous pulsations; electrosurgical interference; and placement of a sensor on an extremity that has a blood pressure cuff, arterial catheter, or intravascular line.

SOLUTION:

- Check that calculations have been corrected appropriately for the relevant variable. In general, calculated saturation values are not as reliable as direct laboratory hemoximeter measurements.
- If there is excessive light, cover the sensor with opaque material.
- Circulation distal to the sensor site should be checked routinely. The site must be inspected every 8 hours to ensure adhesion, skin integrity, and correct optical alignment. If skin integrity changes, move the sensor to another site.

- Try to keep the patient still, or change the sensor site to one with less motion.
- Observe all instructions, warnings, and cautions in this manual and in the directions for use of the sensor.

PROBLEM: A valid SpO₂ signal was present but has disappeared.

CAUSE:

- A BP determination on the same limb is in progress.

SOLUTION:

- An alarm message (No signal) will appear on the screen, and the audible alarm will sound immediately.

PROBLEM: A bad signal error has occurred.

CAUSE:

- Weak or “noisy” signal.

SOLUTION:

Check the patient.

- If possible, keep the patient still; check whether the sensor is applied securely and properly, and replace it if necessary; move the sensor to a new site; or replace the sensor.
- Change sensor type.
- Consider increasing perfusion using heat.
- If there is excessive light, cover the sensor with opaque material.

PROBLEM: A sensor error indicating a bad sensor has occurred.

CAUSE:

- The sensor or cable may be defective, or the cabling may be improperly connected.

SOLUTION:

Check the patient.

- If possible, keep the patient still; check whether the sensor/cable is applied securely and properly, and replace it if necessary.
- Disconnect and reconnect the sensor.

Using the Menu System

Introduction

The PRO Monitor is equipped with a liquid crystal display (25) and a rotor (21). Used together, these allow the operator to view and edit most of the Monitor's parameters and functions. When the Monitor is in use, a number of option buttons appear on the liquid crystal display (LCD). The model of the Monitor determines which menu option buttons appear on the LCD. The number of buttons and the specific options depend on the menu level. The rotor provides the means of choosing menu options and changing monitor settings.

Liquid Crystal Display

The LCD is divided into three areas, each of which has a distinct function.

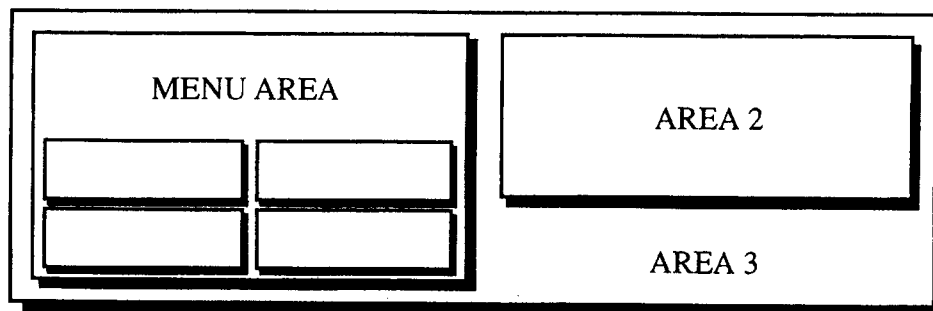

Menu Area

This area displays the menu buttons that are available for selection. Normal text in the menu area appears dark on a light background, while the text of selected buttons appears light on a dark background.

Area 2

This area displays BP and SpO₂ data and error and warning messages. The Display mode menu is used to select the data to be displayed.

Area 3

This area displays the time, the time lapsed since the last Auto BP determination (if in Auto BP mode), the battery icon (if operating on battery power, the time and battery icon toggle), and the BP and printer modes.

Note: In cold ambient temperatures (below 50 °F / 10° C), updates on the LCD can be delayed by approximately 1 second. This delay on the LCD does not affect the performance of the Monitor.

Using the Menu System

Menu Tree

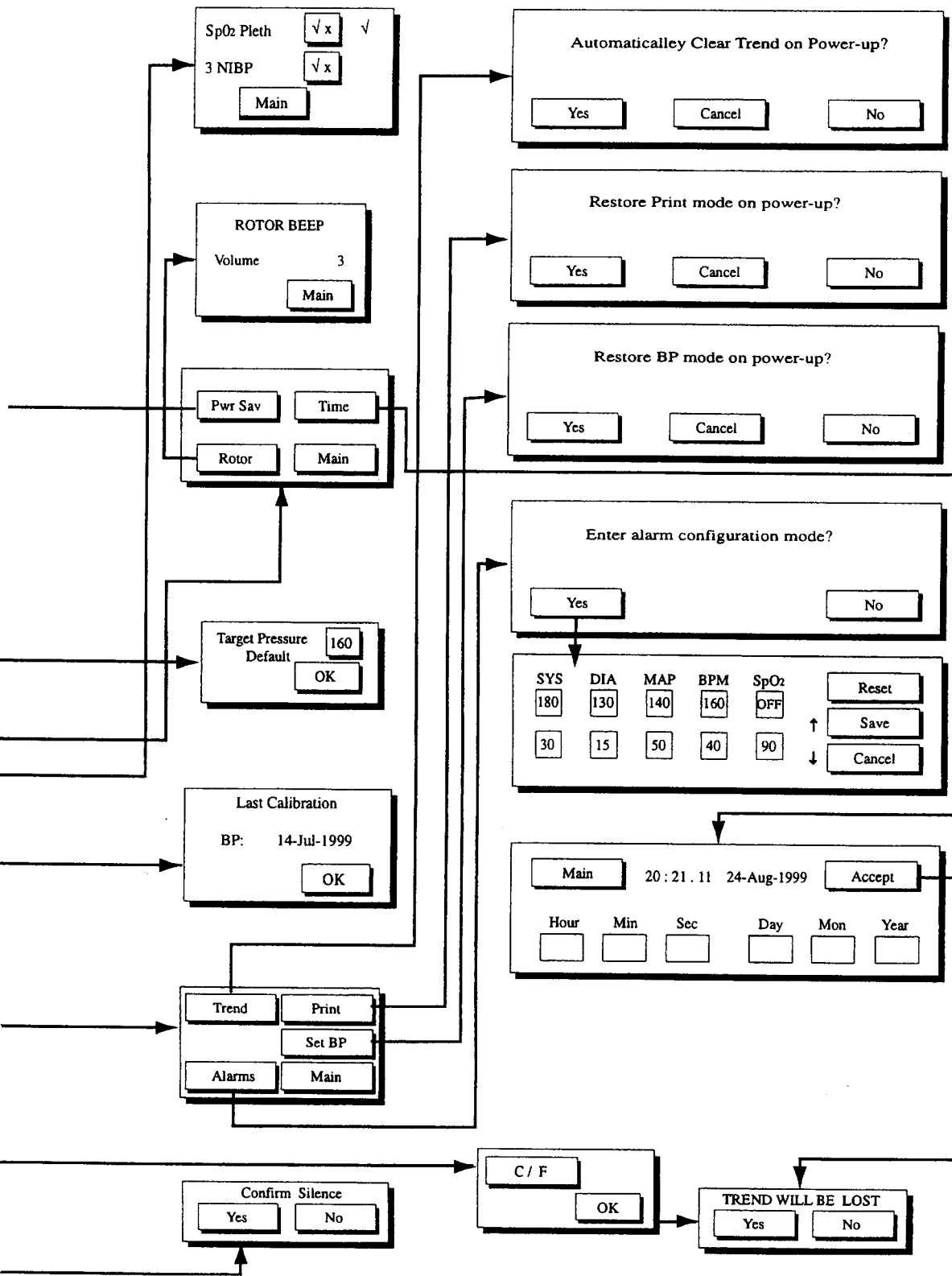

Notes

- The model of the Monitor determines which menu option buttons appear on the LCD.

Rotor

Rotating the rotor causes option buttons to be highlighted (light text on a dark background). Turning the rotor produces a click. Turning it clockwise moves the highlighting clockwise over the available buttons, while turning it counterclockwise reverses the direction of the highlighting. Pressing the rotor selects the highlighted button and produces an audible tone.

Some menus (e.g., Alarms) contain values that can be changed by the operator. After the value is highlighted, the user selects it by pressing the rotor. Turning the rotor clockwise will cause the value to increase, and turning the rotor counterclockwise will cause the value to decrease. Pressing the rotor again will confirm the changed value.

Menu Tree

The menu tree on the previous page shows ***all*** possible choices available within the menu structure, from the top level downward.

Main Menu

This menu is the top level menu. It is displayed when the Monitor is first switched on and after the rotor has been inactive for 2 minutes, unless the Monitor is in sleep mode (Pwr Sav).

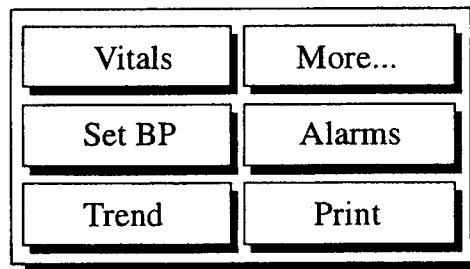

Using the Menu System

Vitals Button (UK: All Obs)

Selection of this button initiates a BP determination while allowing SpO₂ and predictive temperature determinations to be monitored and recorded (depending on Monitor model). When the Vitals determination is complete, a single “warble” sounds and all patient data are displayed on the LEDs and held for 2 minutes or until cleared by the user. The LCD shows:

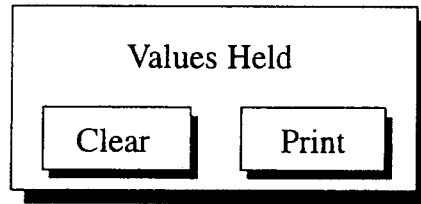

Note: If the printer is in “Auto” mode, the Print button does not appear as an option.

Notes

- If the Monitor is performing a Vitals determination, the Vitals button cannot be selected.
- If a BP determination is in progress, the Vitals button cannot be selected.
- A Vitals determination is canceled if the BP determination is canceled.
- A Vitals determination can be canceled by pressing either the AUTO BP or START/STOP key.
- During the 2 minute freeze period, SpO₂ monitoring and alarms are suspended.

Clear

Selection of this button halts measurements and returns the user to the Main menu.

Note: If the SpO₂ plethysmograph is displayed on the LCD, the waveform pauses for 2 minutes or until the Clear button is selected. SpO₂ values are also retained the same manner as the BP and Temperature values.

Print

Selection of this button causes the current data to be printed.

Notes

- The Print button appears only when Print is set to Manual mode.
- If the printer is in Auto print mode, the data will be printed automatically.

More... Button

Selection of this button displays the More... menu. The More... menu has six options (depending on model of Monitor), most of which have submenus. For this reason, instructions for the More... button are in a separate section.

Set BP Button (UK: BP Mode)

Selection of this button displays the Auto, Stat, and Manual BP menu.

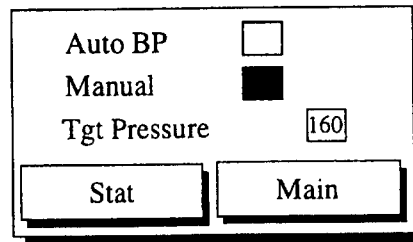

Auto

Selection of this option starts an Auto BP determination. When Auto Mode is selected, a number at the right of the Auto button indicates the time interval between each reading. To change the time interval, choose the box around the number and turn the rotor until the desired interval is reached. The interval can be set between 1 and 120 minutes (1, 2, 3, 4, 5, 10, 15, 20, 25, 30, 45, 60, 90, and 120 minutes). Press the rotor to confirm the setting. After power-off, the operating mode returns to the default setting of Manual. The default setting of Manual can be overridden to return to the previous user-selected setting (Auto or Manual) by selecting Set BP under the Service menu. To cancel an Auto BP determination, select the Manual button in the Set BP (UK: BP Mode) menu.

Manual

Selection of this option starts a Manual BP determination. After power-off, the operating mode returns to the default setting of Manual. The default setting of Manual can be overridden to return to the previous user-selected setting (Auto or Manual) by selecting Set BP under the Service menu.

Using the Menu System

Tgt Pressure

Selection of this option allows the user to set the BP target inflation pressure. The initial target pressure can be set between 100 and 250 mmHg in 5 mmHg increments. The factory default is 160 mmHg for adults and 110 for neonates. (This is indicated by "AUTO" at the end of adjustable range.) When using a neonate blood pressure cuff, if the target pressure is set to greater than 140 mmHg under the Set BP or Clinical menu, the Monitor automatically defaults to a target pressure of 110 mmHg. If the target pressure is set between 100 and 140 mmHg, then that setting is the target pressure that will be used. When the target pressure is changed, the next determination will use the new target inflation value if no systolic is available. Initial target pressure is restored to the factory default setting after power-off. The target pressure can be adjusted permanently in the Clinician menu of the Service mode (refer to "Press" in the "Using the Menu System" section).

Stat

Selection of this option allows the user to start Stat determinations. When Stat is selected, blood pressure is determined as many times as possible in 5 minutes.

Note: Alarm limits are disabled while in Stat mode.

Main

Selection of this button returns the user to the Main menu.

Alarms Button

Selection of this button displays the Alarms menu. This menu is used to adjust the violation limits for BP, Pulse Rate, and SpO₂. The values and ranges for these parameters are not stored when the Monitor is turned off. The user may edit the limits, but they are restored to the default values each time the Monitor is switched on. To permanently change the alarm limits, refer to "Alarms" under "Service Button" in the "Using the Menu System" section.

SYS	DIA	MAP	BPM	SpO ₂	Volume
180	130	140	160	OFF	↑ Auto
30	15	50	40	90	↓ Main

Parameter	Range	Default
Systolic High	35 - 245	180
Systolic Low	30 - 240	30
Diastolic High	15 - 195	130
Diastolic Low	10 - 190	15
MAP High	20 - 215	140
MAP Low	15 - 210	50
Heart Rate High	35 - 250	160
Heart Rate Low	30 - 245	40
SpO ₂ High	51 - 100	Off
SpO ₂ Low	50 - 99	90

Volume

Selection of this button displays the alarm volume submenu. The volume range is from 1 to 10, with 10 being the loudest. The alarm volume is stored when the Monitor is turned off and restored to the user's preference each time the Monitor is switched on. Selection of the **Check** button allows the current volume setting to be heard. Selection of the **Main** button returns the user to the Main menu.

ALARM VOLUME	
5	Check
	Main

Auto

Selection of this button updates the alarm limits on the LCD relative to the current parameter values. Pressing this button will automatically cancel any limit violation alarm that becomes invalid as a result of a limit change. Alarm limits are updated as follows:

Using the Menu System

Parameter Label	Label	High Limit	Low Limit
Systolic	SYS	SYS +30	SYS -30
Diastolic	DIA	DIA +30	DIA -30
MAP	MAP	MAP +30	MAP -30
Heart Rate	BPM	BPM +30	BPM -30
SpO ₂	SpO ₂	SpO ₂ +5*	SpO ₂ -5

* If the reading plus the limit is greater than the valid range of measurement (e.g., SpO₂ +5 is greater than 100%), the valid range of measurement becomes the limits.

Notes

- In no case will the updated alarm limits be set beyond the valid limits in the preceding table.
- If no values are available, the limits will remain unchanged.

Main

Selection of this button returns the user to the Main menu.

Trend Button

Selection of this button displays the Trend mode menu.

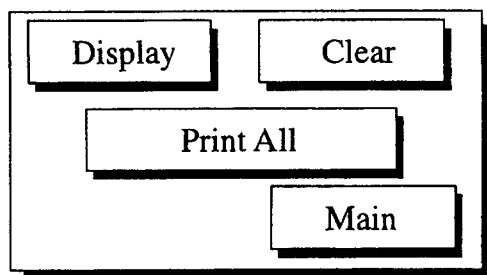

Display

Selection of this button allows the operator to view the trend data.

Note: If the trend data have been lost (e.g., if the clock settings have been changed), the message "Trend Empty" will appear instead of the Newer, Older, and Print page buttons.

TIME	SYS	DIA	MAP	BPM	SpO2	TEMP
11:37	---	---	---	---	---	---
11:42	---	---	---	---	---	---
11:47	---	---	---	---	---	---
11:52	---	---	---	---	---	---

Newer

Older

Print page

Main

Newer and Older. These buttons may be used to move forward and backward through the recorded data. If no information is available, these buttons will not appear.

Print page. Selection of this button causes the displayed information to be printed. If no information is available, this button will not appear.

Main. Selection of this button returns the user to the Main menu.

Clear

Selection of this button produces an advisory that the trend will be lost. Choosing **Yes** will erase the trend memory. Choosing **No** will retain the trend memory. This button disappears from the menu while printing and when Trend is empty.

Print All

Selection of this button prints all the historical data available. When selected, this button temporarily changes to **Cancel** until the history has completed printing. Once printing is complete, the **Cancel** button returns back to the **Print All** button. This button disappears from the menu when Trend is empty.

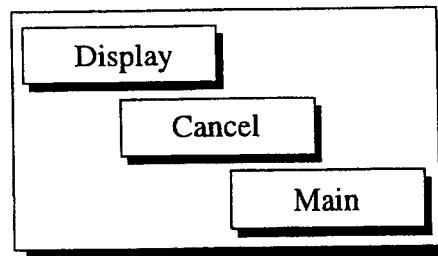

Main

Selection of this button returns the user to the Main menu.

Using the Menu System

Print Button

Selection of this button displays the Print menu.

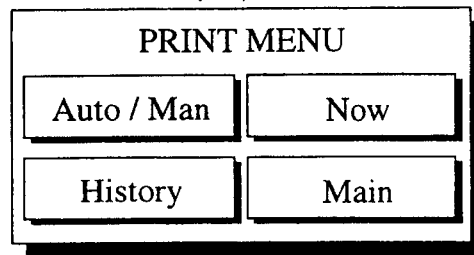

Auto/Man

Pressing this button toggles between Automatic and Manual Printing modes. The current mode is displayed on Area 3 of the LCD. The Automatic mode prints the readings after each determination. The Manual mode, which is the factory default mode, requires the user to press the **Now** button to print the readings.

Now

Selection of this button causes the last readings of the available parameters to be printed. If no readings are available, the message "No reading" is printed for that parameter. An error message appears if there is no paper in the printer.

History

Selection of this button causes the entire contents of the trend memory to be printed. When selected, this button temporarily changes to **Cancel** until the history has completed printing.

Main

Selection of this button returns the user to the Main menu.

More... Menu

This menu is used to set the various operating modes of the Monitor.

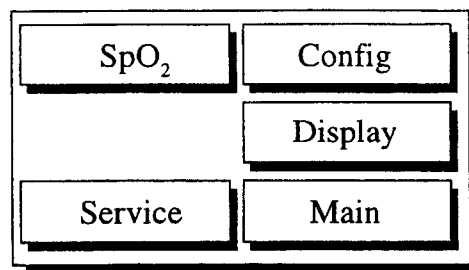

SpO₂ Button (Models 300 and 400)

Selection of this button displays the SpO₂ mode menu, which is used to set the SpO₂ pulse tone volume.

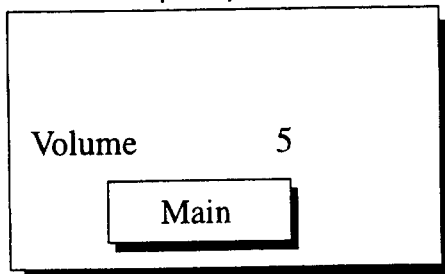

Volume

The pulse tone volume can be set in the range of **Off** to **9**. The value **Off** should be selected if no pulse tone is desired. The volume setting is stored when the Monitor is turned off and is restored to the user's preference each time the Monitor is switched on.

Main

Selection of this button returns the user to the Main menu.

Config Button

Selection of this button displays the Config mode menu, which allows the Power Save mode and time to be adjusted.

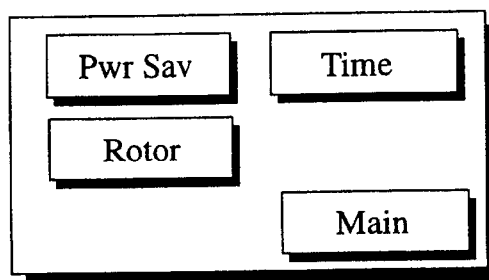

Pwr Sav (Sleep Mode)

Selection of this button allows the operator to specify the time, in minutes, that elapses before the Monitor goes into "sleep" mode (LEDs blanked and LCD displaying values from LEDs). Sleep mode is available only if the Monitor is operating from its battery. Sleep mode conserves power while the Monitor is not in use. Once the Monitor is in Sleep mode, the user can return it to normal operation by touching any button or the rotor.

Using the Menu System

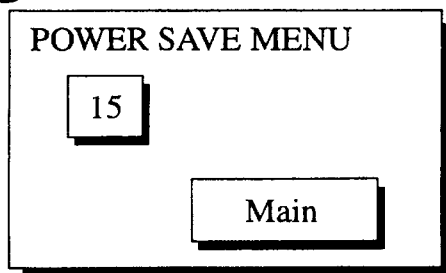

The Monitor enters Sleep mode only if the following are true:

- No alarm is active
- SpO₂ is not actively reporting patient statistics
- The keys and rotor have not been used for the preset time
- The Monitor is running from its battery
- No determinations are in progress
- The Monitor has been running from the battery for the entire preset time

The Monitor awakens from Sleep mode if any of the following occur:

- The rotor is turned or pressed
- Any of the keys are pressed
- An alarm condition is issued
- The battery supply level becomes discharged to a critical level
- A mains or suitable DC supply is connected
- An Auto BP or Temp determination starts
- An SpO₂ signal is detected
- A BP determination is started through the host comm

Time

Selection of this button allows the operator to change the internal time and date of the Monitor. The clock, which is maintained by an internal battery after power down, uses 24-hour format. The date is in the British format of dd/mmm/yyyy; however, to avoid confusion the month number has been substituted with a three-letter abbreviation. Leap years are calculated automatically.

Main		20 : 21 . 11	24-Aug-1999	Accept		
Hour	Min	Sec	Day	Mon	Year	
<input type="text"/>	<input type="text"/>	<input type="text"/>	<input type="text"/>	<input type="text"/>	<input type="text"/>	

Accept. Selection of this button produces an advisory to the user that the trend will be lost when the clock settings are changed. Choosing **Yes** will cause the Monitor to accept the new clock settings and erase the trend memory. Choosing **No** will cause the Monitor to retain the existing clock settings and the trend memory. Either choice returns the user to the Main menu.

Main. Selection of this button returns the user to the Main menu.

Rotor

Selection of this button displays a panel for setting the volume of the beep that sounds when the rotor is turned. The range of adjustment is **Off** (default) to **9**, and the setting is retained when the Monitor is turned off.

ROTOR BEEP	
Volume	3
Main	

Main

Selection of this button returns the user to the Main menu.

Display Button

Selection of this button displays the Display mode menu. This menu is used to specify whether Area 2 of the LCD will display SpO₂ or BP data. If neither SpO₂ nor 3 NIBP is selected, Area 2 of the LCD will remain blank except for the pulse amplitude bar (if SpO₂ data are available) and any error or warning messages that may appear. The Display mode setting is maintained when the Monitor is switched off and on.

Using the Menu System

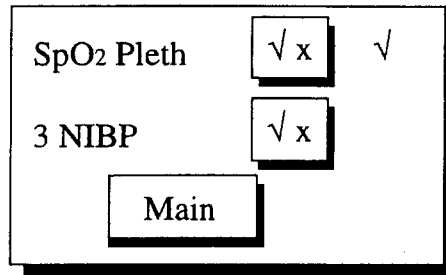

SpO₂ Pleth

When this option is checked and SpO₂ data are available, the plethysmograph waveform and the pulse amplitude bar will be displayed.

3 NIBP

When this option is checked, the last 3 NIBP readings will be displayed. If SpO₂ data is available, the pulse amplitude bar will also be displayed.

Main

Selection of this button returns the user to the Main menu.

Service Button

Selection of this button displays a keypad that allows the clinician to access some parts of the Service mode menu. To access the Clinician menu, use the rotor to select the numbers 1, 2, 3, 4 sequentially.

Notes

- SpO₂ is automatically disabled when entering Service mode.
- Service modes that affect the calibration or alignment of the instrument are not available to the user. These modes are described in the Service Manual.

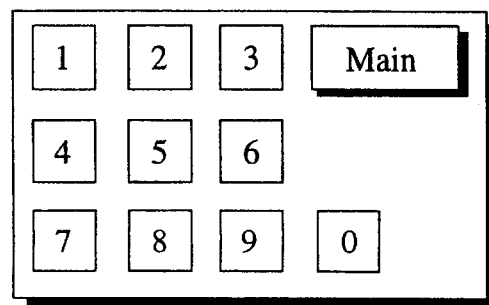

Clinician Menu

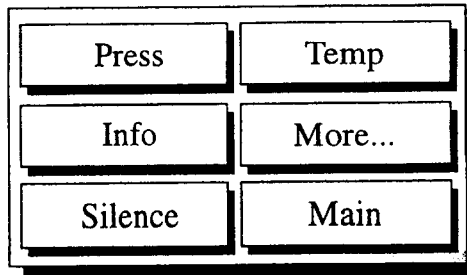

Press. Selection of this button displays a panel for setting the default BP target inflation pressure. Adjusting the default target pressure will automatically update the current inflation target pressure and will be used for the next reading. The range of adjustment is 100 mmHg to 180 mmHg, and the setting is retained when the Monitor is turned off.

The initial target pressure can be set between 100 and 180 mmHg in 5 mmHg increments. The factory default is 160 mmHg for adults and 110 for neonates. This is indicated by the "AUTO" label at the end of the adjustable range. When the target pressure is changed, the next determination will use the new target inflation value if no systolic is available. When adjusted under the Clinician menu of the Service mode, the target pressure is adjusted permanently.

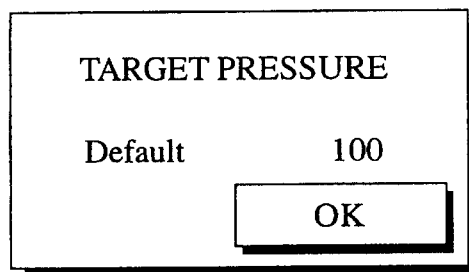

OK. Selection of this button returns the user to the Clinician menu.

Temp. Selection of this button displays the temperature submenu, which allows the user to choose the temperature label. When **C** (Celsius) is selected, the °C indicator lights. When **F** (Fahrenheit) is selected, the °F indicator lights.

Using the Menu System

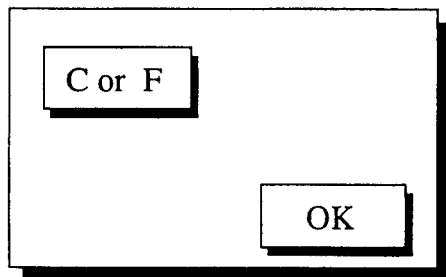

C or F. Selection of this button toggles the temperature display between Celsius and Fahrenheit and produces an advisory that the trend will be lost. Choosing **Yes** will cause the Monitor to accept the new temperature label and erase the trend memory. Choosing **No** will cause the Monitor to retain the existing temperature label and the trend memory.

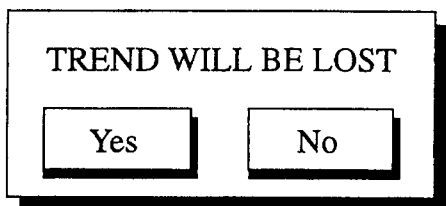

OK. Selection of this button returns the user to the Clinician menu.

Info. Selection of this button causes the most recent calibration date of the NIBP system to be displayed. Selection of **OK** returns the user to the Clinician menu.

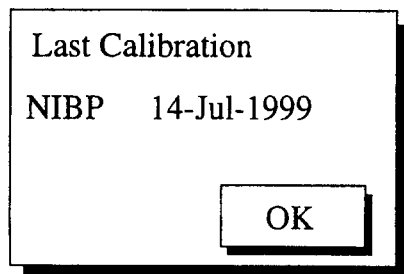

OK. Selection of this button returns the user to the Clinician menu.

More... Selection of this button displays the More... menu, which allows the user to permanently change default mode settings.

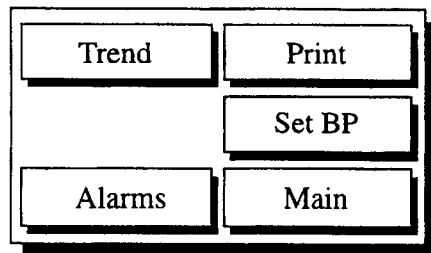

Trend. Selection of this button displays the message: **Automatically clear trend on power-up?** Selection of **Yes** overrides the default setting by clearing all trends on power-up and returns the Monitor to the More... menu. Selection of **No** retains the default setting by saving all trends after power-off and returns the Monitor to the More... menu. Selection of **Cancel** returns the user to the More... menu.

Print. Selection of this button displays the message: **Restore Print mode on power-up?** Selection of **Yes** restores the Print mode to the default setting (previous user-selected mode) after power-off and returns the Monitor to the More... menu. Selection of **No** restores the Print mode to the Manual mode after power-off and returns the Monitor to the More... menu. Selection of **Cancel** returns the Monitor to the More... menu.

Set BP. Selection of this button displays the message: **Restore BP mode on power-up?** Selection of **Yes** restores the BP mode to previous user-selected mode after power-off and returns the Monitor to the More... menu. Selection of **No** restores the BP mode to the default setting of Manual after power-off and returns the Monitor to the More... menu. Selection of **Cancel** returns the Monitor to the More... menu.

Alarms. Selection of this button displays the message: **Enter alarm configuration mode?** Selection of **No** returns the Monitor to the More... menu. Selection of **Yes** brings up the Alarms menu. Selection of **Reset** changes all alarm limits back to the factory defaults and returns the Monitor to the More... menu. Selection of **Save** permanently saves the user-selected alarm limits and returns the Monitor to the More... menu. Selection of **Cancel** returns the Monitor to the More... menu.

SYS	DIA	MAP	BPM	SpO ₂	Reset
180	130	140	160	OFF	Save
30	15	50	40	90	Cancel

Using the Menu System

Main. Selection of this button returns the user to the Main menu.

Silence. Selection of this button will cause all alarms except the FAILSAFE alarm to be muted. A confirmation menu will appear in Area 2 of the LED. Selection of either **Yes** or **No** returns the user to the Clinician mode menu. If silence is confirmed, the Alarm Silence button (26) illuminates and alarms are permanently muted. If silence is not confirmed, the alarm will be audible.

Caution: Alarms will be muted until either the Monitor is switched off and on again or the Alarm Silence button (26) is pressed.

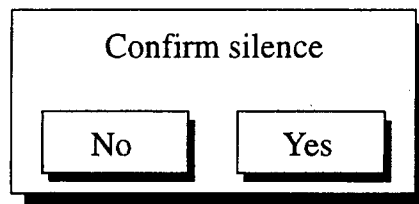

Main. Selection of this button returns the user to the Main menu.

Error and Warning Messages

The error panel appears in Area 2 of the LCD and indicates the error and its code, if it has one. In this example, a limit violation alarm (which has no error code) has occurred. A list of alarm error messages and their codes is in Appendix B.

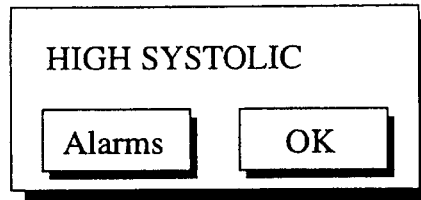

Alarm conditions are addressed in two ways: the Alarms button and OK button.

Alarms Button

Selection of this button takes the user to the Alarms menu, where the alarm limits can be adjusted. This button is available only when a parameter alarm limit has been violated.

OK Button

Selection of this button acknowledges the error. The Monitor clears the identified error and then returns the user to the Main menu.

Appendix A

Technical Specifications

BP

Cuff Pressure Range
(Normal operating range) 0 to 290 mmHg (adult)
0 to 140 mmHg (neonate)

Default Target: Cuff Inflation 160 ± 15 mmHg (adult)
110 ± 15 mmHg (neonate)

Target Cuff Inflation:
Adjustment Range 100 to 250 mmHg (adult)
100 to 140 mmHg (neonate)
(in 5 mmHg increments)

Blood Pressure Measurement

Range (mmHg)	Systolic	MAP	Diastolic
Adult	30 - 245	15 - 215	10 - 195
Neonate	40 - 140	30 - 115	20 - 100

Blood Pressure Accuracy Meets or exceeds ANSI/
AAMI standard SP-10
(mean error ≤ 5 mmHg,
standard deviation ≤ 8
mmHg)

Maximum Determination Time 120 s (adult)
85 s (neonate)

Overpressure Cutoff 300 to 330 mmHg (adult)
150 to 165 mmHg (neonate)

Pulse Rate Range 30 to 200 beats/min (adult)
30 to 200 beats/min (neonate)

Pulse Rate Accuracy ± 3.5%

IVAC* Temperature

Scale °Fahrenheit (F)
°Celsius (C)

Range
Predictive mode Max: 42.2° C; 108.0° F
Min: 31.6° C; 88.9° F

*IVAC is a trademark of ALARIS Medical Systems

Monitor mode	Max: 42.2° C; 108.0° F Min: 26.7° C; 80.0° F
Monitor mode accuracy	± 0.1° C ± 0.2° F (when tested in a calibrated liquid bath; meets ASTM E1112, Table 1, in range specified)
Predictive mode accuracy	± 1.0° F ± 0.6° C
Determination time	less than 60 seconds

Use only IVAC probes and probe covers. The size, shape, and thermal characteristics of the probe covers can affect the performance of the instrument. Inaccurate readings or retention problems may occur unless IVAC probes and probe covers are used. Refer to Appendix D for reorder codes.

SpO₂

Functional Oxygen Saturation:

Range	0 to 100%
Accuracy	0 to 69%: unspecified

Adult Accuracy (70% - 100%)

<u>NELLCOR Sensor</u>	<u>Accuracy</u>
OXICLIQ-P pediatric sensor	2.5 digits
OXICLIQ-I infant sensor	2.5 digits
OXICLIQ-A adult sensor	2.5 digits
OXICLIQ-N neonatal/adult sensor	2.5 digits
OXIBAND pediatric/infant sensor	3.0 digits
OXIBAND adult/neonatal sensor	3.0 digits
DURA-Y ear clip	3.5 digits
REFLECTANCE sensor	3.5 digits
DURASENSOR adult	3.5 digits
PEDI-CHECK pediatric spot-check clip	3.5 digits
OXISENSOR II D-20 pediatric sensor	2.0 digits
OXISENSOR II D-25 adult sensor	2.0 digits
OXISENSOR II N-25 neonatal/adult sensor	2.0 digits
OXISENSOR II I-20 infant sensor	2.0 digits
OXISENSOR II D-25L adult sensor, long cable	2.0 digits

Appendix A

OXISENSOR R-15 adult nasal sensor*

3.5 digits

*Accuracy: 80% to 100%; 0 to 79%: unspecified.

Neonatal Accuracy (70% - 100%)

When sensors are used on neonatal subjects as recommended, the specified accuracy range is increased by ± 1 digit to account for the theoretical effect on oximeter measurements of fetal hemoglobin in neonatal blood (e.g., N-25 accuracy on neonates is ± 3 , rather than ± 2).

Note: Refer to NELLCOR's sensor specifications.

Pulse Rate Range	30 to 250 beats/min
Accuracy	± 3 beats/min
Audible Indicator	Pitch changes with saturation; volume selectable from 0 (off) to 9
Waveforms	Pulse plethysmograph waveform on LCD gain compensated
Sensor Connect/ Disconnect From Patient	Monitor will detect attachment or disconnection of sensor from patient within 15 s
Pulse Detection	Monitor will detect pulse or enter no signal state within 15 s of being attached to patient
Loss of Pulse	Monitor will detect loss of pulse from patient and enter no signal state within 10 s
<u>Sensor Light Source</u>	
Wavelength	Infrared: 920 nm (nominal) Red: 660 nm (nominal)
Power Dissipation	Infrared: 22.5 mW (max) Red: 30 mW (max)

Mechanical

Dimensions	Height: 9.8 in (25.0 cm) Width: 9.8 in (24.8 cm) Depth: 6.9 in (17.5 cm)
Weight, Including Battery	7.8 lb (3.5 kg)
Mountings	Self-supporting on rubber feet or pole mountable
Portability	Carried by recessed handle or pole mounted
Classification Information	Mode of operation: continuous Degree of protection against harmful ingress of water: Drip-proof IPX1

Power Requirements

AC input voltage: 100-240 VAC,
50 / 60 Hz (nominal)
90 ~ 253 VAC, 47 ~ 63 Hz (range),
50VA.

Protection against electrical
shock: Class 1

DC input voltage: 24 VDC
(nominal), 12-30 VDC, 36VA,
supplied from a source conforming
to IEC 601-1.

AC input is protected by two
internal fuses, replaceable by
qualified service personnel only. DC
input line is protected by an internal
auto-resetting fuse.

Battery: 12 volt, 2.3 amp-hours
protected by internal auto-resetting
fuse.

Minimum operation time:
2 hrs (5 min cycle with adult cuff at
25 °C with power save mode

Appendix A

enabled) from full charge. Time for full recharge: 1 hr 50 min from full discharge when the Monitor is switched off and 8 hrs when the Monitor is switched on.

Environmental

Operating Temperature	+ 5 °C to + 40 °C (+ 41 °F to + 104 °F)
Operating Atmospheric Pressure	700 hPa to 1060 hPa
Storage Temperature	- 20 °C to + 50 °C (- 4 °F to + 122 °F)
Storage/Transportation Atmospheric Pressure	500 hPa to 1060 hPa
Humidity Range	0% to 95% noncondensing
Radio Frequency	Complies with IEC Publication 601-1-2 (April 1993) Medical Electrical Equipment, Electromagnetic Compatibility Requirements and Tests and CISPR 11 (Group 1, Class A) for radiated and conducted emissions.

IPX1

The DINAMAP® PRO Monitor is protected against vertically falling drops of water and conforms with the IEC 529 standard at level of IPX1. No harmful effects will come of vertically falling drops of water making contact with the Monitor.

Appendix B

Alarm Codes

All alarm indications are accompanied by an audible signal unless Alarm Silence is selected.

A microprocessor system failure will generate a high-pitched audible alarm regardless of the setting of the Alarm Silence switch.

There are three categories of alarms: patient alarms, system alarms, and failsafe alarm.

Patient Alarms

Patient alarms include those alarms issued when the patient's systolic pressure, diastolic pressure, pulse rate, or oxygen saturation is outside the set limits. Whenever one of these conditions occurs, the associated display (SYSTOLIC, MAP, DIASTOLIC, PULSE, or SpO₂) will flash the most recent reading and an audible alarm will be issued.

Pressing the Alarm Silence switch (causing the integral LED to be lit) silences the audible alarm for 2 minutes, but the alarm display reading and SILENCE LED indicator will continue to flash at the same rate.

System Alarms

System alarms alert the operator to certain abnormal conditions or internal system failures. Pressing the rotor cancels the alarm information box which is displayed on the LCD. Codes for different procedural and system alarms are on the next page.

Failsafe Alarm

The failsafe alarm, which is the most powerful alarm of the PRO Monitor, indicates a serious failure of the Monitor. This alarm occurs immediately upon any failure of a self-test and indicates system failure. When the failsafe alarm occurs, the Monitor disables all features to ensure patient safety.

Hierarchy of Alarms

Alarms in the DINAMAP® PRO Monitor are in three priority levels. They are:

Alarm	Priority Level
Failsafe	1
Patient and system	2 (High priority alarm)
Low battery	3

The Priority 1 alarm (i.e., Failsafe) will override any other alarm. Priority 2 alarms will override only the low battery alarm. The low battery alarm will not override any other alarm.

Appendix B

Procedural and Error Alarm Codes						
Alarm Code	LED Display	LCD Display	Audible Tone and Volume	Effect of Alarm Silence Switch	Effect of Clear via SelectKnob	Probable Cause
N99	No change	N99 - NIBP FAILED	High priority alarm. Volume adjustable	2 minutes silence	Clear	Unable to make an NIBP determination due to insufficient signal
N55	No change	N55 - TIMEOUT: PRESS	High priority alarm. Volume adjustable	2 minutes silence	Clear	One cuff pressure for > 1 minute. Motion artifact
N44	No change	N44 - TIMEOUT: TOTAL	High priority alarm. Volume adjustable	2 minutes silence	Clear	Determination time > 2 minutes. Motion artifact
N33	No change	N33 - TIMEOUT: INFLT	High priority alarm. Volume adjustable	2 minutes silence	Clear	Inflation time > 40 seconds or air leak detected
N00	No change	N00 - OVER PRESSURE	High priority alarm. Volume adjustable	2 minutes silence	Clear	Overpressure detected

Procedural and Error Alarm Codes (cont.)							
Alarm Code	LED Display	LCD Description	Audible Tone and Volume	Effect of Alarm Silence Switch	Effect of Clear via SelectKnob	Probable Cause	
P55	No change	P55 - SpO ₂ NO SIGNAL	High priority alarm. Volume adjustable	2 minutes silence	Clear	No or very low SpO ₂ signal. Check or reposition sensor	
P00	No change	P00 - NO SpO ₂ SENSOR	High priority alarm. Volume adjustable	2 minutes silence	Clear	SpO ₂ sensor not connected. No sensor code detected. Sensor failure	
No Code	No change	SpO ₂ PLACEMENT?	High priority alarm. Volume adjustable	2 minutes silence	Clear	SpO ₂ signal weak or noisy. Sensor failure	
No Code	Values zeroed	SpO ₂ CABLE?	High priority alarm. Volume adjustable	2 minutes silence	Clear	SpO ₂ sensor or cable possibly defective. Cable not connected properly	
E33	No change	E33 - TEMP: FAIL	High priority alarm. Volume adjustable	2 minutes silence	Clear	Temperature probe not connected or inoperable	
E00	No change	E00 - TEMP: FAIL	High Priority alarm. Volume adjustable	2 minutes silence	Clear	Predictive temperature determination > 60 sec or attempting axillary temp	
No Code	Blank	HIGH TEMP	High Priority alarm. Volume adjustable	2 minutes silence	Clear	Predictive temperature exceeds upper range	

Appendix B

Procedural and Error Alarm Codes (cont.)							
Alarm Code	LED Display	LCD Description	Audible Tone and Volume	Effect of Alarm Silence Switch	Effect of Clear via SelectKnob	Probable Cause	
No Code	No Change	LOW BATTERY, Flashing battery icon	3 beeps every 10 seconds, adjustable volume	2 minutes silence	No effect	Replace or recharge battery. From onset of alarm, 5 NIBP measurements available. Beep rate increases linearly as battery discharges	
No Code	Blank	LOW BATTERY - SYSTEM DISABLED	Steady tone, maximum volume	No effect	No effect	Replace or recharge battery. NIBP measurement disabled	
No Code	No Change	PRINTER - NO PAPER	High Priority alarm. Volume adjustable	2 minutes silence	Clear	Paper ran out or printer door open	
No Code	Values Posted	NIBP RANGE ERROR	High Priority alarm. Volume adjustable	2 minutes silence	Clear	NIBP algorithm returned value outside specified accuracy range	
Other: N, P, E, I, S	Blank	Error code, description	Steady tone, maximum volume	No effect	No effect	Internal system fault	

Appendix C

Principles of Noninvasive Blood Pressure

Determination

The oscillometric method of determining BP is accomplished by a sensitive transducer which measures cuff pressure and minute pressure oscillations within the cuff. The first determination sequence initially pumps up to a cuff pressure of about 160 mmHg for adult/pediatric patients, or 110 mmHg for neonates depending on the initial target pressure preset. After inflating the cuff, the Monitor begins to deflate it and measures systolic pressure, mean pressure, and diastolic pressure. When the diastolic pressure has been determined, the Monitor finishes deflating the cuff and updates the systolic, diastolic, and MAP displays on the front panel.

The Monitor deflates the cuff one step each time it detects two pulsations of relatively equal amplitude. The time between deflation steps depends on the frequency of these matched pulses (pulse rate of the patient). However, if the Monitor is unable to find any pulse within several seconds, it will deflate to the next step. The process of finding two matched pulses at each step provides artifact rejection due to patient movement and greatly enhances the accuracy of the Monitor. The figure shows the BP determination sequence.

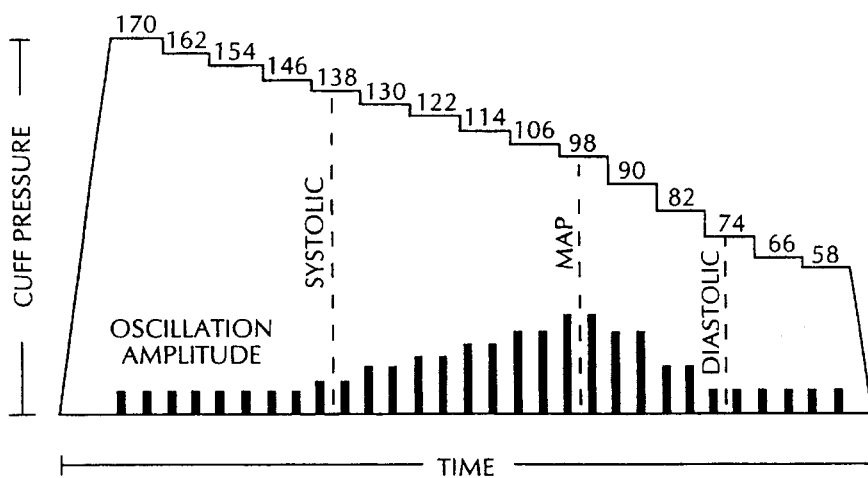

BP Determination Sequence

At each step the microprocessor stores cuff pressure, the matched pulse amplitude, and the time between successive pulses. The stepped deflation and matched pulse detection continues until diastolic pressure is determined or total cuff pressure falls below 7 mmHg. The Monitor then deflates the cuff (to zero detected pressure), analyzes the stored data, and updates the front panel displays.

The operating cycle is composed of four parts: inflation time, deflation time, evaluation time, and wait time. Wait time, which varies from mode to mode, is affected by the cycle time (Auto mode) or operator intervention (Manual mode). The figure shows the Basic Operating Cycle.

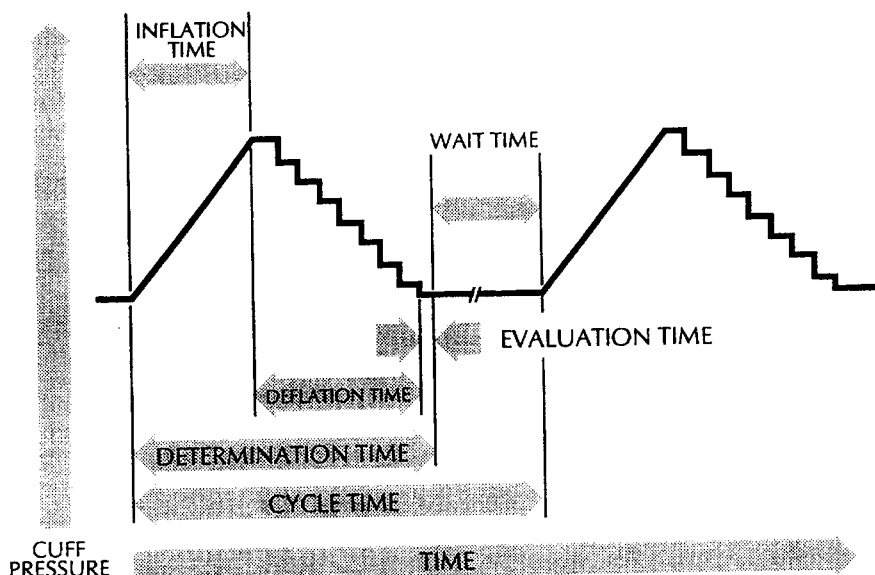

BP Operating Cycle

Systolic Search

If systolic pressure is not found, the Monitor can search at higher cuff pressures than the initial target pressure. If the determination is in a late stage, the Monitor will inflate the cuff to 70 mmHg above the initial target to get better data in the systolic region. If the determination is in an early stage, the Monitor will inflate the cuff to 50 mmHg above the initial target pressure. The maximum pressure allowed in systolic search is limited by the normal range for cuff pressures. In any operating mode, if a patient's systolic pressure exceeds the inflation pressure of the Monitor, the Monitor will begin normal deflation sequence, detect the

Appendix C

absence of a systolic value, stop deflation, reinflate to a higher (than initial) inflation pressure (290 mmHg maximum), and resume normal deflation sequence. This additional inflation will occur only once per determination.

If a previous valid systolic pressure is displayed, and the new systolic pressure oscillations are compared with the previous valid determination and the Monitor “thinks” that the systolic was not obtained, the Monitor will inflate the cuff to a pressure of an additional 50 mmHg above the immediately preceding inflation. This additional inflation will occur only once per determination.

Do not use the auscultatory method to verify the accuracy of the Monitor. Because of differences in technique and technology, values may differ. The DINAMAP® Technology of the PRO Monitor compares BP values to an invasive arterial BP measurement technology. The auscultatory method uses audible sounds heard through a stethoscope and determines BP by the corresponding height of a column of mercury.

Invasive pressure monitoring directly measures the pressure exerted on a transducer and displays this pressure as a value. Noninvasive blood pressure monitoring is dependent on the flow of blood through the peripheral circulation.

Appendix D

Compatibility Table and Reorder Codes

Description of Compatible Parts	Code
SOFT-CUF™, Infant	2500
SOFT-CUF™, Child	2501
SOFT-CUF™, Small Adult	2502
SOFT-CUF™, Adult	2503
SOFT-CUF™, Large Adult	2504
SOFT-CUF™, Thigh	2505
SOFT-CUF™, Neonatal Type 1	2521
SOFT-CUF™, Neonatal Type 2	2422
SOFT-CUF™, Neonatal Type 3	2523
SOFT-CUF™, Neonatal Type 4	2524
SOFT-CUF™, Neonatal Type 5	2525
DURA-CUF® Cuff, Infant	2783
DURA-CUF® Cuff, Child	2781
DURA-CUF® Cuff, Small Adult	2779
DURA-CUF® Cuff, Adult	2774
DURA-CUF® Cuff, Large Adult	2791
DURA-CUF® Cuff, Thigh	2796
DURA-CUF® Cuff, Assortment Cuff Pack	2699
DURA-CUF® Cuff, Child Pack	2697
CLASSIC-CUF™, Infant	2618
CLASSIC-CUF™, Child	2613
CLASSIC-CUF™, Small Adult	2608
CLASSIC-CUF™, Adult	2603
CLASSIC-CUF™, Large Adult	2643
CLASSIC-CUF™, Thigh	2648
CLASSIC-CUF™, Neonatal Type 1	2638
CLASSIC-CUF™, Neonatal Type 2	2633
CLASSIC-CUF™, Neonatal Type 3	2628
CLASSIC-CUF™, Neonatal Type 4	2623
CLASSIC-CUF™, Neonatal Type 5	2619
12 Foot (approx. 3.7 m) Long Adult / Pediatric Hose	107365
24 Foot (approx. 7.3 m) Long Adult / Pediatric Hose	107366
12 Foot (approx. 3.7 m) Long Neonatal Hose	107368
12 Foot (approx. 3.7 m) Long A/P Hose Quick Discon.	88847
IVAC** Oral Temperature Probe	088012
IVAC** Rectal Temperature Probe	088013
IVAC** Temperature Probe Covers	088015
DINAMAP® PRO Monitor Operation Manual	776995*
DINAMAP® PRO Monitor Service Manual	777105*

*PRO Monitor unique parts

**IVAC is a trademark of ALARIS Medcial Systems

12 Volt Lead Acid Battery	633132
Accessory Pole/Basket	3210
Accessory Base	3211
Power Converter	621262*
Printer Paper (box of 10)	089100*
Power Cable	316579
NELLCOR SpO ₂ Extension Cable	SCP10*
NELLCOR Finger Sensor	DS100A
BP Cal Kit	320246

*PRO Monitor unique parts
 NELLCOR is a trademark of Mallickrodt, Inc.

NEONATAL CUFF TYPE	LIMB CIRCUMFERENCE	REFERENCE NUMBER	USE WITH HOSE NO.
#1	3 cm - 6 cm	2521/2638	107368 Teal Green, Neonatal, 12 ft (366 cm)
#2	4 cm - 8 cm	2422/2633	
#3	6 cm - 11 cm	2523/2628	
#4	7 cm - 13 cm	2524/2623	
#5	8 cm - 15 cm	2525/2619	

ADULT/PEDIATRIC CUFF TYPE	LIMB CIRCUMFERENCE	REFERENCE NUMBER	USE WITH HOSE NO.
Infant	8 cm - 13 cm	2703/2500/2618	107365 Adult 12 ft (366 cm) Air Hose Gray (made with Clippard screw connectors at cuff end) or 107366 Adult 24 ft (732 cm) Air Hose Gray (made with Clippard screw connectors at cuff end) or 88847 Long A/P 12 ft (366 cm) Air Hose (quick disconnect)
Child	12 cm - 19 cm	2781/2501/2613	
Small Adult	17 cm - 25 cm	2779/2502/2608/2607	
Adult	23 cm - 33 cm	2774/2503/2603/2602	
Large Adult	31 cm - 40 cm	2791/2504/2643/2642	
Thigh	38 cm - 50 cm	2796/2505/2648	

Appendix F

Maintenance

Cleaning the Monitor

The Monitor and accessories are to be kept clean and used according to the instructions provided here and in the Service Manual.

The exterior of the Monitor may be wiped clean with a soft cloth slightly dampened with mild detergents. The Monitor and accessories should be inspected once yearly for wear and damage.

- Do **not** immerse unit.
- Do **not** clean with isopropyl alcohol or other solvents.
- Do **not** immerse hoses.

Cuff Cleaning and Disinfection

General

The cuff must be thoroughly cleaned with the specified detergent before reuse. The additional use of household bleach as described below provides at least intermediate-level disinfection.

- Apply cuff hose plugs before cleaning.
- The following cleansing procedure was repeated 20 times on DURA-CUF® Blood Pressure Cuffs and once on SOFT-CUF® Blood Pressure Cuffs without affecting the performance of the cuff.
- While this procedure is adequate for cleaning/disinfection, it may not remove all stains.
- Do **not** immerse hoses.
- Do **not** immerse cuffs without prior application of cuff hose caps.

Materials

- Enzymatic detergent such as ENZOL* enzymatic detergent (US) or Cidezyme* enzymatic detergent (UK)
- Distilled water
- 10% solution of household bleach (5.25% sodium hypochlorite) in distilled water

*Trademark



- Soft cloths and soft-bristled brushes
- Spray bottles

Procedure

1. Prepare the enzymatic detergent according to the manufacturer's instructions and the 10% bleach solution, in separate spray bottles.
2. Spray the detergent liberally on device. If the material is dried on, allow the cuff to sit for 1 minute. For soil on the soft part of the closure or the cuff itself, wipe the material off with a soft cloth. For persistent contamination on the soft part of the closure, use a soft-bristled brush to loosen particles. Rinse with copious amounts of distilled water. Repeat until no visible contamination remains. For soil on the hook part of the closure, use a soft-bristled brush to remove the material, and rinse with copious amounts of distilled water. Repeat until no visible contamination remains.
3. Spray the 10% bleach solution on the affected area until the area is saturated. Allow the cuff to sit for 5 minutes.
4. Wipe away any excess solution and rinse the cuff again with distilled water. Allow 2 hours for drying.

The user has the responsibility to validate any deviations from the recommended method of cleaning and disinfection.

For additional information on infection control procedures, contact Critikon Technical Support.

Temperature Devices

Do not immerse predictive temperature probes. The probe may be cleaned with an alcohol solution. Use a cloth or sponge—just damp, not wet—and avoid getting any liquid into the interior of the probe.

SpO₂ Sensors

Adhesive sensors are sterile and for single use only. Reusable sensors should be cleaned before reuse with a 70% alcohol solution. Do not immerse the sensor completely in water, solvents, or cleaning solutions (because the connector is not waterproof). Do not sterilize the sensor by irradiation, steam, or ethylene oxide. If

Appendix F

disposable sensors or their packaging are damaged, they must be disposed of as advised in Appendix F.

Storage and Battery Care

If it becomes necessary to store the Monitor for an extended period of time, first fully charge then remove the battery. Then store the Monitor and the battery in the original packaging materials.

Batteries should always be fully charged before being placed in storage. Even after 6 months of storage, a fully charged battery can retain about 80% of its charge. A fully charged battery in good condition will provide sufficient power to operate a Monitor for approximately 2 hours, including temperature and BP measurements made at 5-minute intervals.

It is best to keep the battery charged as fully as practical and never store the Monitor with the battery in a discharged condition. When the battery will no longer hold a charge, remove and replace it with one of the same part number. Failure to replace the battery with the same Critikon part number may result in shorter battery life.

To charge the battery, insert the plug from either the AC mains power cord or the AC-DC power converter into an appropriate AC outlet. The battery will charge regardless of the position of any switches.

Battery charging will take place as long as the Monitor remains connected to an external AC power source. A battery that is fully discharged can be fully recharged in 1 hour 50 minutes when the Monitor is switched off or 8 hours if the Monitor is switched on.

Cautions

- **To ensure that the battery will be ready for portable operation, keep the Monitor connected to a mains supply whenever possible.**
- **Repeated failure to fully charge the battery will result in a significant reduction in battery life.**

- **The expected lifetime of the battery largely depends on the way in which the Monitor is used. If the battery is allowed to completely discharge before being fully recharged, the battery should survive around 200 recharge cycles. If the battery is used in such a way that it never becomes more than one third discharged and is fully recharged whenever possible, it can survive up to 1200 cycles. This means that by thoughtful usage, the lifetime of the battery can be extended up to six times.**

Replacement batteries may be obtained from Critikon.

Note: The replacement part number of the battery is 63313. Do not use other types.

Fuses

The Monitor contains five fuses. Two AC line input fuses are mounted internally and are replaceable only by qualified service personnel. The remaining three fuses are auto-resettable and mounted within the Monitor. These fuses protect the low voltage DC input, the battery, and the +5 V output on the host port connector.

Calibration

Calibration of the BP parameter should be checked at least once a year or when there is doubt about the validity of the readings.

Leak Testing

A leak test of the BP parameter should be performed at least once a year or when there is doubt about the validity of the pressure readings.

Caution: Refer calibration and leak testing to qualified service personnel. Full calibration details are available in the DINAMAP PRO Monitor Service Manual, available from Critikon.

Disposal of Product Waste

As you use the PRO Monitor, you will accumulate solid wastes that require proper disposal or recycling. These include batteries, patient applied parts, and packaging material.

Appendix F

Batteries

Caution: Do not incinerate batteries.

The sealed, rechargeable backup battery contains lead and can be recycled. The rechargeable memory battery is of the Nickel Metal Hydride form. Discharge this battery prior to disposal. Place the battery in packaging which electrically isolates its contents. Do not puncture or place the battery in a trash compactor. Do not incinerate the battery or expose it to fire or high temperatures. Dispose in accordance with regional body controlled guideline.

Patient Applied Parts

Certain patient applied parts, such as those with adhesive (disposable SpO₂ sensors), are intended for single use and should be disposed of properly as medical waste in accordance with regional body controlled guideline.

Other patient applied parts, such as blood pressure cuffs, should be cleaned according to instructions. Inspect reusable applied parts for wear, replace as necessary, and dispose of used product as medical waste in accordance with regional body controlled guideline.

Packaging Material

Retain original packaging materials for future use in storing or shipping the Monitor and accessories. This recommendation includes corrugated shippers and inserts.

Whenever possible recycle the packaging of accessories and patient applied parts.