

MEDLEY™
MEDICATION SAFETY SYSTEM
INFUSION PUMP MODULE
Model 8100

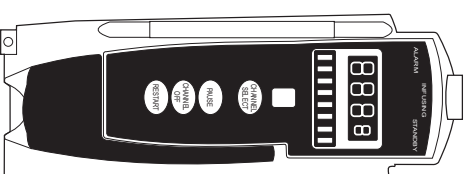

DIRECTIONS FOR USE

**INFUSION PUMP MODULE
MODEL 8100**

TABLE OF CONTENTS

INTRODUCTION

ABOUT THE SYSTEM	1
FEATURES	2
SYMBOLS	4

GETTING STARTED

WARNINGS AND CAUTIONS	5
CONTROLS AND INDICATORS	10
INSTALLATION PROCEDURE	12
ATTACHING AND DETACHING CHANNELS	12
START-UP SEQUENCE	12
PREPARING INFUSION	13
DISPLAYS	15
PRIMARY MODE	15
SECONDARY MODE	23
CHANNEL LABELS	27
POWERING OFF	29
CHANGING PRIMARY SOLUTION CONTAINER	29
CHANGING AND RELOADING SET DURING INFUSION	29
DRUG CALCULATION PARAMETERS	30
SETTING UP DRUG CALCULATION WITH DRUG LIBRARY	31
SETTING UP DRUG CALCULATION FOR NON-LIBRARY DRUGS	33
SETTING BOLUS DOSE (DRUG CALCULATION WITH DRUG LIBRARY)	36
SETTING BOLUS DOSE (DRUG CALCULATION FOR NON-LIBRARY DRUGS)	38
ANESTHESIA MODE	41
REVIEWING SERIAL NUMBER	44
REVIEWING SOFTWARE VERSION	44

ALARMS, ADVISORIES AND PROMPTS

DEFINITIONS	45
AUDIO CHARACTERISTICS	46
ALARMS	47
ADVISORIES	48
ERRORS	49

MAINTENANCE

SPECIFICATIONS	51
CONFIGURABLE SETTINGS	53
CHECK-IN AND CONFIGURATION	54
CLEANING	54
INSPECTION REQUIREMENTS	55
SERVICE INFORMATION	55
WARRANTY	56

APPENDIX

TRUMPET AND START-UP CURVES	57
-----------------------------------	----

INTRODUCTION

GETTING STARTED

ALARMS, ADVISORIES
AND PROMPTS

MAINTENANCE

APPENDIX

GENERAL CONTACT INFORMATION

Customer Advocacy

For clinical and technical questions, feedback, and troubleshooting assistance.

Phone, toll-free, within the United States and Canada: (800) 854-7128, Ext. 7812

E-Mail: CustomerFeedback@alarismed.com

Technical Support

For technical information related to maintenance procedures and service manual support.

Phone:

(858) 458-6003

Toll-free, within the United States: (800) 854-7128, Ext. 6003

Toll-free, within Canada:

Eastern: (800) 227-7215

Western: (800) 667-2335

For more detailed information, refer to the "Service Information" section of this document.

About the System

The MEDLEY™ Medication Safety System is a modular infusion and monitoring system intended for use in today's growing professional healthcare environment, including healthcare facilities and home care, for use on adults, pediatrics and neonates.

The MEDLEY™ Pump Module is intended for facilities that utilize infusion pumps for the delivery of fluids, medications, blood and blood products using continuous or intermittent delivery through clinically acceptable routes of administration; such as, intravenous (IV), intra-arterial (IA), subcutaneous, epidural, enteral, or irrigation of fluid spaces.

The MEDLEY™ Medication Safety System consists of the Programming Module (Model 8000), the Guardrails® Safety Software, and detachable modules (or "channels"), which provide infusion or monitoring capabilities.

This document provides directions for use for the Model 8100 Infusion Pump Module. Please read all instructions, for both the Pump Module and Programming Module, before using the device.

The MEDLEY™ System uses a wide variety of ALARIS® MEDLEY™/ Gemini Administration Sets. The sets are designed for use with the Pump Module as well as for gravity-flow, stand-alone use. For specific administration set instructions, refer to the directions for use provided with the set. For set priming and loading instructions, refer to the "Start-Up Sequence" section of this document.

Contraindications: None known.

Features

Anesthesia Mode	The Anesthesia Mode allows the anesthesiologist to access additional drugs in each profile that are appropriate to anesthesiology. This mode also features permanent pause and the ability to set higher air-in-line settings.
AutoRestart	The AutoRestart feature is part of the MEDLEY™ System's advanced Downstream Occlusion Detection system. If enabled, the AutoRestart feature minimizes nuisance patient side occlusion alarms caused by momentary kinking of tubing, IV pushes, etc.
Bolus Dose	The Bolus Dose mode enables the clinician to program a bolus infusion. It is possible to program a bolus using the Guardrails® Drug Library or using the Drug Calculation feature. The bolus infusion can be programmed with or without a continuous infusion following the bolus.
Channel Labels	The Channel Label feature is available if the Profiles feature is enabled. It provides a hospital-defined list of labels which can be displayed in the Channel Message Display, allowing the user to identify the channel with the solution being infused, the catheter location or other helpful information.
Drug Calculation	The Drug Calculation mode allows the user to: enter the desired drug dose and the MEDLEY™ System calculates the correct flow rate to achieve the desired dose, OR enter the desired flow rate and the MEDLEY™ System calculates the corresponding drug dose.
Dynamic Pressure Display	The Dynamic Pressure Display is located just below the Channel Status information in the Main Display of the Programming Module. If enabled, it graphically displays the current patient side occlusion pressure set point and the current patient side operating pressure for that channel.
Flow Rates	The flow rate range is from 0.1 to 999 mL/h. Rates between 0.1 and 99.9 may be selected in 0.1 mL/h increments. Rates from 100 to 999 mL/h are selected in 1 mL/h increments.
Free Flow Protection	All MEDLEY™/Gemini Disposable Sets utilize a unique clamping device, the Flo-Stop® Device, to prevent inadvertent free flow when the set is removed from the instrument.
Guardrails® Drug Library	The Guardrails® Drug Library feature is a Drug Calculation mode available when the Profiles feature is enabled. It provides a hospital-defined list of up to 100 drugs and concentrations appropriate for use in the selected profile. Using the Drug Library automates programming steps, including the drug name, drug amount and diluent volume, and activates the hospital-established best-practice Guardrails® Limit.

Features (Continued)

Guardrails® Prompt	<p>The Guardrails® Safety Software is designed to help prevent programming errors by:</p> <ul style="list-style-type: none"> • Customizing device configurable settings to meet the need of the selected hospital area/unit (profile). • Comparing user programming with hospital-defined best-practice guidelines. • Providing a Guardrails® Prompt if an out-of-limits entry is made.
Occlusion Pressure	<p>The MEDLEY™ System provides a complete range of Downstream Occlusion Detection options, including:</p> <ul style="list-style-type: none"> • Pump mode, where the downstream occlusion alarm threshold is 525 mmHg at flow rates of 30 mL/h or greater. For rates <30 mL/h, the occlusion pressure is rate-dependent, to ensure rapid response to occlusions. • Selectable pressure mode, where the downstream occlusion alarm threshold can be adjusted by the user in 25 mmHg increments, up to the maximum occlusion pressure of 525 mmHg. • AutoRestart (see previous page) <p>In addition, the MEDLEY™ System provides fluid side occlusion detection.</p>
Profiles	<p>The Profiles feature allows a unique set of system options (profile) to be configured to optimize system function for a specific hospital area or patient type. A profile is comprised of a configuration, with system settings and defaults customized by the user to best meet the needs of the profile area/patient type.</p>
Secondary Infusions	<p>Dual rate sequential piggyback (Secondary) infusions may be infused at delivery rates and volumes independent of the primary infusion parameters. Automatic changeover occurs to the primary infusion parameters when the secondary infusion is complete if a MEDLEY™/Gemini Check Valve Administration Set is used.</p>
System Configuration	<p>The System Configuration mode provides the ability for qualified personnel to customize device settings. If the Profiles feature is enabled, the system settings defined for the selected profile are automatically activated.</p>
Tamper Resist	<p>The Tamper Resist feature provides a quick, one-touch lockout of the front keypad.</p>
Volume/Duration	<p>The Volume/Duration infusion option allows the user to program a volume-to-be-infused (VTBI) and duration (infusion time), and the flow rate is automatically calculated.</p>
Volume-To-Be-Infused (VTBI)	<p>The volume-to-be-infused (VTBI) range is from 0.1 to 9999 mL. Volumes between 0.1 and 999.9 may be selected in 0.1 mL increments. VTBI's from 1000 to 9999 mL are selected in 1 mL increments.</p>

Symbols



Canadian and U.S. Certification Mark: Products bearing this mark have been tested and certified in accordance with applicable U.S. and Canadian electrical safety and performance standards (CSA C22.2 No. 601.1, UL 2601-1 and IEC 60601-2-24).



Electrical Shock Protection Rating: Type CF, Defibrillation-proof

IPX1

Protection against fluid ingress: Drip Proof



Attention: Refer to accompanying documentation.



IUI Connector: Inter-Unit Interface connector used to establish power and communications between the Programming Module and add on channels.



Manufacturing Date: Number adjacent to symbol indicates the month and year of manufacture.



Consult operating instructions.

R_x Only

CAUTION: Federal (U.S.A.) law restricts this device to sale by or on the order of a physician.

Single-Use



Single-Use. Do not re-use.



Product contains a particular element; such as,  = DEHP in fluid pathway.



Product DOES NOT contain a particular element; such as,  = set is latex-free.



Drops per milliliter specification for product will be identified on drop symbol.



Product incorporates SmartSite[®] Needle-Free Valve Ports and should not be accessed by a needle.



Approximate set priming volume.



Expiration date for product will be identified near hour glass symbol.

NOTE: Although the MEDLEY™ System is built and tested to exacting specifications, it is not intended to replace the supervision of IV infusions by medical personnel. The user should become thoroughly familiar with the features and operation of the MEDLEY™ System and exercise vigilance in its utilization.

Rx Only

Definitions

WARNING

This heading alerts the user to potential serious outcomes (death, injury or serious adverse events) to the patient or user.

CAUTION

This heading alerts the user to take special care for the safe and effective use of the device.

Warnings and Cautions

For WARNINGS and CAUTIONS for the Programming Module, refer to its Directions for Use.

To ensure proper performance of the MEDLEY™ System and to reduce potential injury, observe the following precautions:

Epidural Administration

The MEDLEY™ System can be used for epidural administration of anesthetic and analgesic drugs. This application is only appropriate when using analgesics and anesthetics labeled for continuous epidural administration and catheters intended specifically for epidural use. Use only a MEDLEY™/Gemini Series set, **without** a 'Y' connector or injection port, for epidural infusions.

- Epidural administration of anesthetic drugs: Use indwelling catheters specifically indicated for short term (96 hours or less) anesthetic epidural drug delivery.
- Epidural administration of analgesic drugs: Use indwelling catheters specifically indicated for either short term or long term analgesic epidural drug delivery.

WARNING

Epidural administration of drugs other than those indicated for epidural use could result in serious injury to the patient.

WARNING

It is strongly recommended that the infusion pump, source container and MEDLEY™/Gemini Administration Set used for epidural drug delivery be clearly differentiated from those used for other types of administration.

Warnings and Cautions (Continued)

WARNING

This instrument is designed to stop fluid flow under alarm conditions. Periodic patient monitoring must be performed to ensure the infusion is proceeding as expected.

WARNING

This infusion device is a positive pressure delivery system, capable of developing positive fluid pressures to overcome widely varying resistances to flow encountered in practice, including resistances to flow imposed by small gauge catheters, filters and intra-arterial infusion. It is neither designed nor intended to detect infiltrations and will not alarm under infiltration conditions.

WARNING

Hospital personnel must ensure the compatibility of the drugs as well as the performance of each channel as part of the overall infusion. Potential hazards include drug interactions, inaccurate delivery rates, inaccurate pressure alarms and nuisance alarms.

WARNING

Do not use the MEDLEY™ System during Magnetic Resonance Imaging (MRI).

WARNING

Use only MEDLEY™/Gemini Series administration sets. The use of any other set may cause improper instrument operation, resulting in an inaccurate fluid delivery or other potential hazard.

WARNING

The use of positive displacement infusion devices ported together with gravity flow infusion systems into a common IV site may impede the flow of common "gravity only" systems, affecting their performance. Hospital personnel must ensure the performance of the common IV site is satisfactory under these circumstances.

WARNING

References in this document to specific drugs and drug doses are for example only. Refer to specific drug product labeling for information concerning appropriate administration techniques and dosages.

Warnings and Cautions (Continued)

Parallel Infusions

There are no contraindications regarding the use of the MEDLEY™ System with any other positive displacement infusion device when ported together into a common IV site location.

User Precautions

To ensure proper performance of the MEDLEY™ System and to reduce potential injury to the operator, observe the following precautions:

- Disconnect from main (AC) and battery power when performing maintenance.
- Do not open the instrument case. There are no user serviceable parts inside. The case should only be opened by qualified service personnel using proper grounding techniques. When the case is opened, an electrical shock hazard exists which can result in serious injury to persons and instrument component damage.

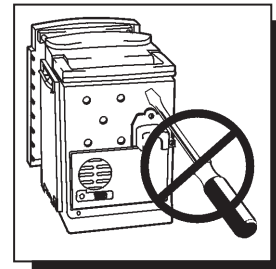

Administration Sets

- A list of approved IV sets recommended by ALARIS Medical Systems for use with the MEDLEY™ Medication Safety System Pump Module is listed on the Set Compatibility Card.
- Before operating the instrument, verify that the administration set is free from kinks and installed correctly in the instrument.
- MEDLEY™/Gemini Series sets are supplied with a sterile fluid path for one time use. Do not resterilize.
- For set replacement interval, refer to facility protocol and/or government standards (such as, CDC guidelines in the United States).
- For IV push medication (put instrument on hold), clamp tubing above the port.
- Flush port(s) per facility protocol.
- Discard administration set per facility protocol.

WARNING

Use only MEDLEY™/Gemini Series administration sets. The use of any other set may cause improper instrument operation, resulting in an inaccurate fluid delivery or other potential hazard.

Warnings and Cautions (Continued)

User Precautions (Continued)

Artifacts

It is normal for an infusion device to produce nonhazardous currents when infusing electrolytes. These currents vary proportional to the infusion device flow rate. When the ECG monitoring system is not functioning under optimal conditions, these currents may appear as artifacts, simulating actual ECG readings. To determine if ECG abnormalities are caused by patient condition or the ECG equipment, place the infusion device on hold. If the ECG readings become normal, the ECG equipment requires attention. Proper setup of the ECG equipment should eliminate these artifacts. Reference the appropriate ECG monitoring system documentation for instructions on setup and maintenance.

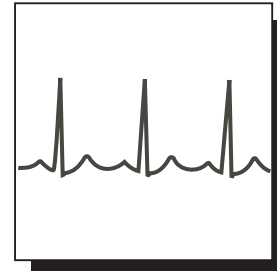

Dropping/Jarring

Should an instrument be dropped or severely jarred, it should be immediately taken out of use and inspected by qualified service personnel, to ensure its proper function prior to reuse.

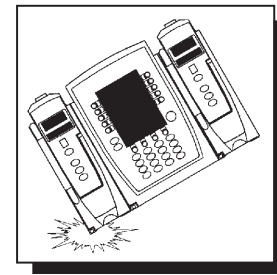

Operating Environment

Not for use in the presence of flammable anesthetics.

◀ DANGER ▶

Explosion risk if used in the presence of flammable anesthetics.



Warnings and Cautions (Continued)

User Precautions (Continued)

Radio Frequency Interference

Operating the system near equipment which radiates high energy radio frequencies (electrosurgical/cauterizing equipment, portable radios, cellular telephones, etc.) may cause false alarm conditions. If this happens, reposition the device away from the source of interference or turn off the device and manually regulate the flow with the clamp and/or monitor the vital parameters using an appropriate clinical alternative.

WARNING

Use of accessories or cables other than those specified may result in degraded electromagnetic compatibility performance of this device.

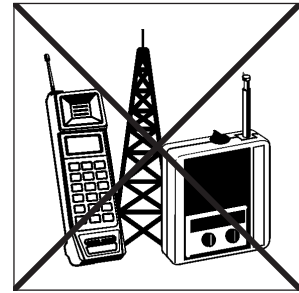

Controls and Indicators

Front/Side View - Door Closed

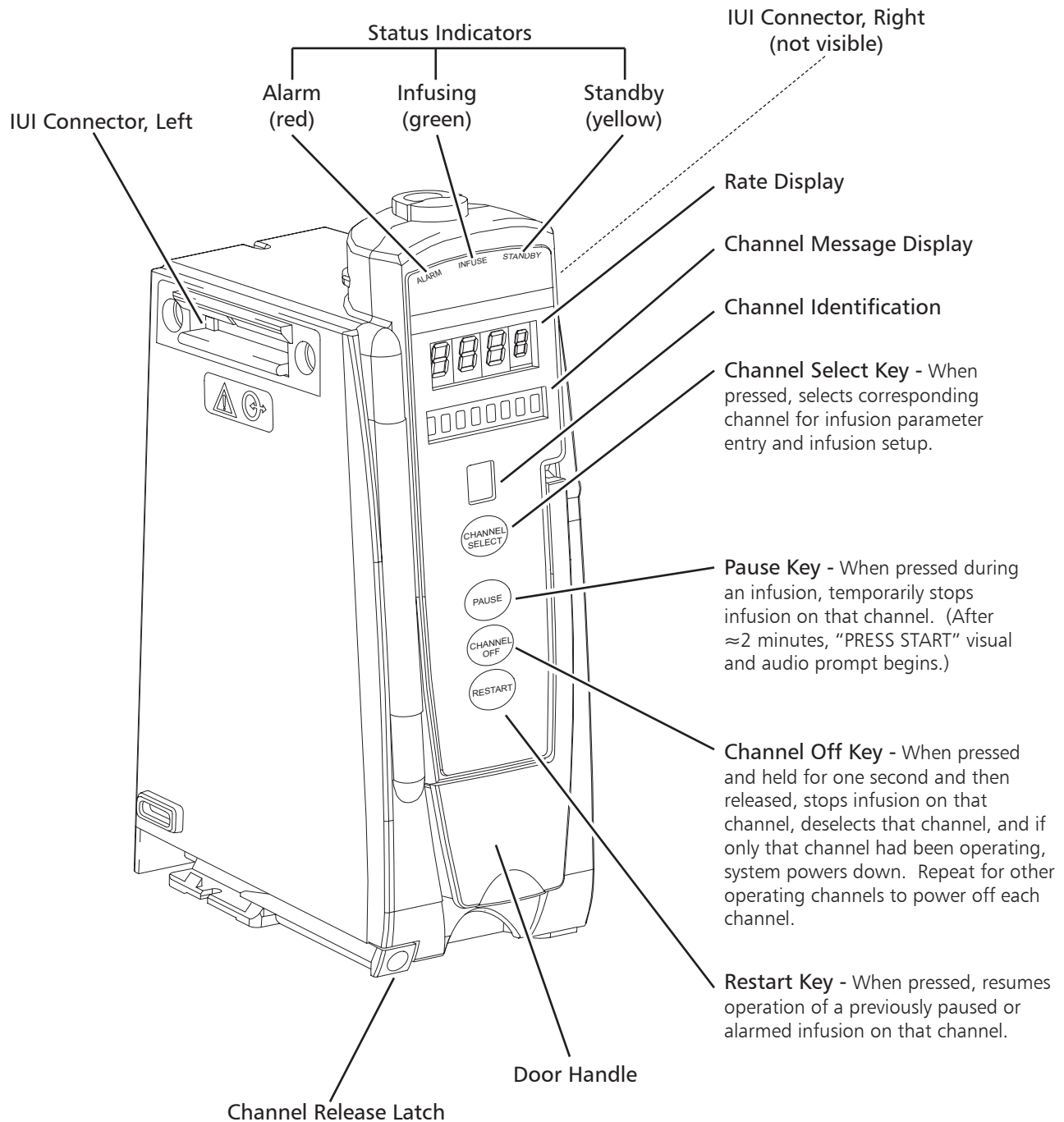

Controls and Indicators (Continued)

Front View - Door Open

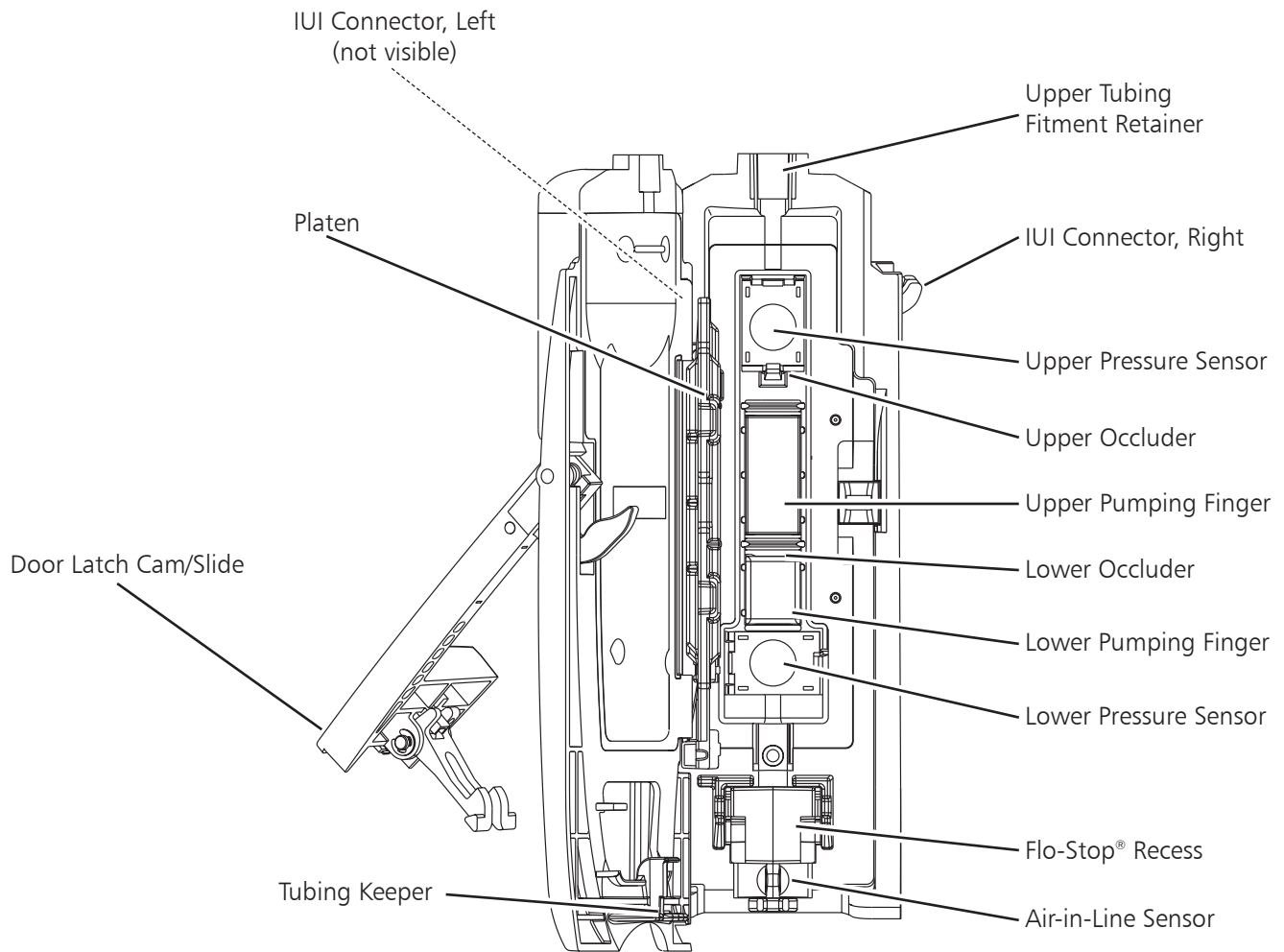

Installation Procedure

Instruments are tested and calibrated before they are packaged for shipment. They met the specifications listed in the Directions for Use at that time. To ensure proper operation after shipment, it is recommended that an incoming inspection be performed before placing the instrument in use.

Unpacking the Pump Module

1. Remove Pump Module from its carton.
2. Verify door operates freely.
3. Verify membrane covering inside surface of pumping unit is not cut or torn.
4. Check for loose parts.
5. Perform Periodic Inspection (see "Inspection Requirements" section in "Maintenance" chapter.)
6. Perform check-in procedure (see "Check-In and Configuration" section in "Maintenance" chapter).

If the Pump Module is damaged, contact ALARIS Medical Systems for authorization to return the equipment for repair, whether damage or malfunction is the responsibility of the carrier or ALARIS Medical Systems.

Attaching and Detaching Channels

Refer to the MEDLEY™ Programming Module (Model 8000) Directions for Use for detailed instructions on attaching and detaching channels.

Start-Up Sequence

Powering On the System

1. Connect MEDLEY™ Programming Module to an external AC power source.
2. Press **SYSTEM ON** key on Programming Module.
3. System self test begins:
 - Diagnostics test causes all LED display segments and Status Indicator lights of attached channel(s) to illuminate briefly.
 - Power Indicator illuminates.

Start-Up Sequence (Continued)

Powering On the System (Continued)

- Appropriate channel identification (A, B, C or D) is displayed on attached channel(s).
 - An Audio tone sounds.
4. At completion of system-on test, “New Patient?” screen appears on Programming Module.

NOTE: *If any of the following conditions are observed, the Programming Module or the affected channel must be removed from use and inspected by qualified personnel:*

- LED segments are not illuminated during system-on test.
- Indicator lights do not illuminate.
- Appropriate channel identification (A, B, C or D) is not displayed.
- Audio tone does not sound.
- Main Display does not appear backlit, appears irregular, or has evidence of a row of pixels not functioning properly.

If the affected channel operates normally when it is attached via the alternate IUI connector, it may be used until a replacement channel can be substituted.

Preparing Infusion

Preparing Primary Solution Container

Prepare the primary solution container in accordance with the manufacturer’s directions for use.

Preparing Primary Administration Set

Use only a MEDLEY™/Gemini Series administration set (refer to Set Compatibility Card for a list of compatible sets). Open the administration set package, remove the set and close the roller clamp. Refer to the set’s Directions For Use, on the administration set packaging.

Loading Primary Administration Set

1. Insert set spike into prepared fluid container, following accepted hospital procedure, and hang container 20 inches above Pump Module.
2. Fill drip chamber to 2/3 full.
3. Open roller clamp slowly, to prime tubing and clear air from injection sites and tubing fitments.

Preparing Infusion (Continued)

Loading Primary Administration Set (Continued)

4. Close roller clamp.
5. Open Pump Module door. Install administration set pumping chamber by properly positioning upper fitment into fitment recess and then inserting the Flo-Stop® Fitment into recess below mechanism, with arrow pointing into Pump Module.
6. Using a finger tip, firmly push tubing toward back of Air-in-Line Detector.
7. Close Pump Module door and open roller clamp. Verify no fluid is flowing through drip chamber.

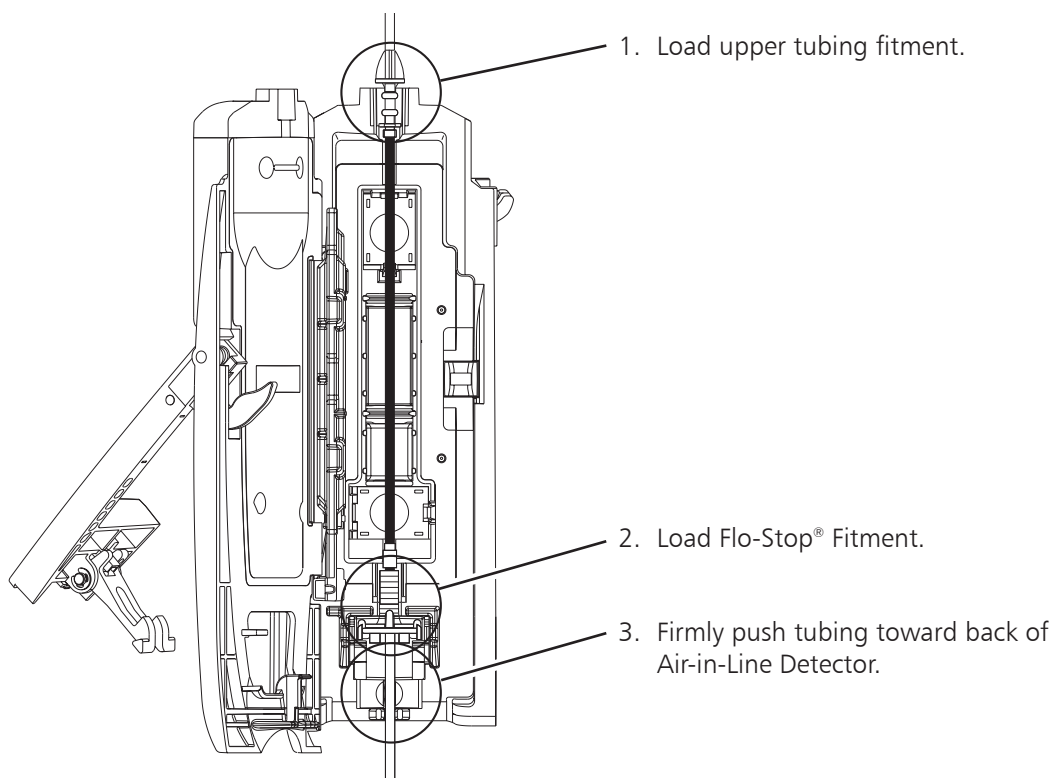

Preparing Set to Deliver Primary Fluids with Gravity Infusion

1. Prime set per steps 1 - 4 in "Loading Primary Administration Set" section.
2. Attach set to patient's vascular access device.
3. Adjust flow rate with set roller clamp.

Displays

Main Display

Refer to the MEDLEY™ Programming Module (Model 8000) Directions for Use for general information in the Main Display.

Title Bar

Channel Status

- A solid Channel Letter display indicates channel is operating.
- An outlined Channel Letter display indicates channel is attached and ready for use.

Soft Keys

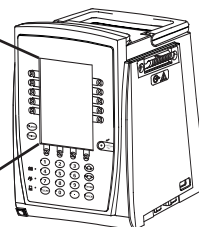
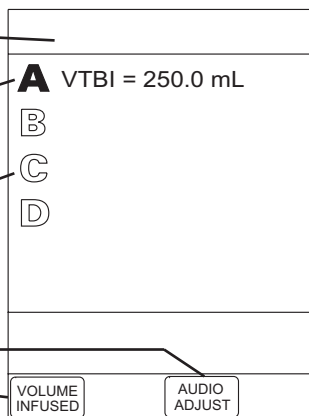

Dynamic Pressure Display

Dynamic Pressure Display

Current operating pressure is indicated by solid bar.

Patient side occlusion pressure set point is indicated by tick mark.

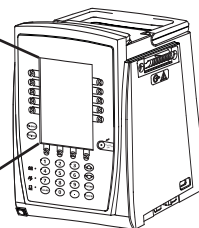
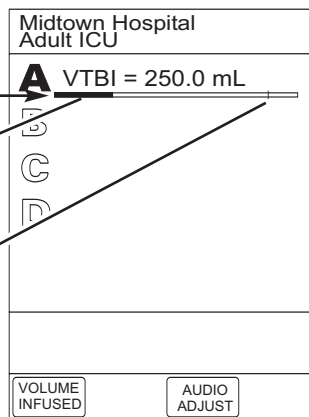

Primary Mode

Primary - Rate/Volume Infusion

NOTE: Throughout this section, the Main Display screens are aligned so that they coincide with the applicable step.

1. Prime and load administration set as described in "Preparing Infusion" section.
2. Press **CHANNEL SELECT** key on desired Pump Module.

A	Infusion Setup
RATE	___ mL/h
VTBI	___ mL
>Select RATE	

Primary Mode (Continued)

Primary - Rate/Volume Infusion

- Press **RATE** soft key and use numeric data entry keys to enter desired flow rate.

A	Infusion Setup
RATE	_ 40 mL/h
VTBI	_ _ _ _ mL
>Select VTBI	

- Press **VTBI** soft key and use numeric data entry keys to enter desired VTBI.
- Attach set to patient's vascular access device.

A	Infusion Setup
RATE	40 mL/h
VTBI	_ 250 mL
>Press START	
PAUSE	SECONDARY START

- Verify correct infusion parameter entry and press **START** soft key on Programming Module.

NOTE: The infusion may also be paused by pressing the **PAUSE** soft key on the Programming Module.

- Green Infusing Status Indicator illuminates.
- Channel Rate Display displays Rate.
- VTBI counts down in Main Display.
- At completion of infusion, an audio prompt sounds, "INFUSION COMPLETE-KVO" scrolls in Channel Message Display and red Alarm Status Indicator flashes. Rate Display changes to KVO rate and KVO displays next to channel indicator in Main Display.

Midtown Hospital Adult ICU	
A	VTBI = 250.0 mL
B	
C	
D	
VOLUME INFUSED	AUDIO ADJUST

Primary - Volume/Duration Infusion

- Prime and load administration set.
- Press **CHANNEL SELECT** key on desired Pump Module.

A	Infusion Setup
RATE	_ _ _ mL/h
VTBI	_ _ _ _ mL
>Select Rate or Restore Previous Infusion	
RESTORE	VOLUME DURATION

Primary Mode (Continued)

Primary - Volume/Duration Infusion (Continued)

3. Press **VOLUME/DURATION** soft key.

A Infusion Setup
RATE = ___ mL/h
VTBI ___ mL
DURATION ___ h ___ min
>Select VTBI
RESTORE RATE VOLUME

4. Press **VTBI** soft key and use numeric data entry keys to enter desired VTBI.

A Infusion Setup
RATE = ___ mL/h
VTBI 1000 mL
DURATION ___ h ___ min
>Select DURATION
RATE VOLUME

5. Press **DURATION** soft key and use numeric data entry keys to enter desired duration of the infusion.

A Infusion Setup
RATE = 125 mL/h
VTBI 1000 mL
DURATION _8:00 hh:mm
>Press START
PAUSE RATE VOLUME SECONDARY START

6. Attach set to patient's vascular access device.
7. Verify correct infusion parameter entry and press **START** soft key.
- Green Infusing Status Indicator illuminates.
 - Channel Rate Display displays Rate.
 - VTBI counts down in Main Display.
 - At completion of infusion:
 - a. An audio prompt sounds.
 - b. "INFUSION COMPLETE-KVO" scrolls in Channel Message Display.
 - c. Red Alarm Status Indicator flashes.
 - d. Rate Display changes to KVO rate.
 - e. KVO displays next to channel indicator in Main Display.
 - f. Channel infuses at KVO rate.

Primary Mode (Continued)

Pausing an Infusion

1. Press **PAUSE** key on Pump Module.
 - “PAUSE” scrolls in Channel Message Display.
 - “PAUSED” appears next to appropriate channel in Main Display.
 - Yellow Standby Status Indicator illuminates.
 - After two minutes, “PAUSE-RESTART CHANNEL” visual and audio prompts begin.
2. To reinitiate an infusion:
 - Press **RESTART** key on Pump Module.
 - OR
 - Press **CHANNEL SELECT** key and press **START** soft key.

Midtown Hospital Adult ICU	
A	PAUSED
B	VTBI = 497.0 mL
C	VTBI = 57.0 mL
D	VTBI = 249.0 mL
VOLUME INFUSED	AUDIO ADJUST

Restarting an Infusion Following Infusion Complete - KVO

1. Press **CHANNEL SELECT** key on Pump Module.

2. Press **VTBI** soft key on Programming Module and use numeric data entry keys to enter desired VTBI, or press **RESTORE** soft key to bring back original volume-to-be-infused from system memory.
3. Replace solution container and refill drip chamber, if necessary.
4. Verify correct infusion parameter entry and press **START** soft key.

A Infusion Setup	
RATE	40 mL/h
VTBI	0 mL
>Select VTBI	
RESTORE	VOLUME DURATION

A Infusion Setup	
RATE	40 mL/h
VTBI	_500 mL
>Press START	
PAUSE	VOLUME DURATION
SECOND- ARY	START

Primary Mode (Continued)

Changing Rate or VTBI During an Infusion

1. Press **CHANNEL SELECT** key on Pump Module.
2. Press either **RATE** or **VTBI** soft key on Programming Module.

A Infusion Setup	
RATE	40 mL/h
VTBI	240 mL
>Press START	
PAUSE	SECONDARY START

3. Use numeric data entry keys, or **Up** and **Down** keys for Rate titration, to enter desired parameter.
4. Verify correct infusion parameter entry and press **START** soft key.

A Infusion Setup	
RATE	_50 mL/h
VTBI	240 mL
>Press START	
PAUSE	SECONDARY START

Stopping an Infusion on a Channel

Press and hold **CHANNEL OFF** key on Pump Module for one second.

NOTE: The channel will initiate the power down at the release of the **CHANNEL OFF** key.

Selecting Pressure Mode - Pump (P) / Selectable (S)

1. Press **CHANNEL SELECT** key on Pump Module.
2. Press **OPTIONS** key on Programming Module.

A Channel Options 1 of 1	
Drug Calculation Setup	
Pressure Limit - P	
Channel Labels	
>Select an Option or EXIT	
EXIT	

Primary Mode (Continued)

Selecting Pressure Mode - Pump (P) / Selectable (S) (Continued)

3. Press **Pressure Limits** soft key.
4. Press either **Pump** or **Selectable** pressure soft key. If **Selectable** is pressed, continue with next step; otherwise, proceed to step 7.

A
Pressure Limit Selection
<div style="border: 1px solid black; padding: 2px; display: inline-block;">Pump</div> <div style="border: 1px solid black; padding: 2px; display: inline-block;">Selectable</div>
>Select an Option or EXIT
EXIT

5. Use either **Up** or **Down** soft key to select desired occlusion pressure limit.
6. Verify correct occlusion pressure limit input and press **Confirm** soft key.
7. Press **START** soft key.

A
Pressure Limit Selection
Selectable Pressure
525 mmHg
<div style="border: 1px solid black; padding: 2px; display: inline-block;">Up</div> <div style="border: 1px solid black; padding: 2px; display: inline-block;">Down</div>
CONFIRM

Viewing and Clearing Volume Infused for ALL Channels

1. Press **VOLUME INFUSED** soft key on Programming Module.
 - Total Volume Infused (Primary + Secondary), and time and date Volume Infused was last cleared, is displayed for each infusion channel.

NOTE: Date format is year-month-day.

- If no key is pressed, main screen appears after 30 seconds.

Volume Infused		
TOTAL VOLUME (mL)	LAST CLEARED	
A 401.1	08:00	2002-03-10
B 42.5	07:30	2002-03-11
C 478.1	08:00	2002-03-10
D 789.1	12:00	2002-03-10
>Select Channels to Clear or Press CLEAR ALL		
PRI/SEC VOLUME	CLEAR ALL	MAIN SCREEN

- To view Primary and Secondary volume(s) infused, press **PRI/SEC VOLUME** soft key.

Volume Infused		
	PRI (mL)	SEC (mL)
A	401.1	0.0
B	42.5	0.0
C	428.1	50.0
D	739.1	50.0
>Select Channels to Clear or Press CLEAR ALL		
TOTAL VOLUME	CLEAR ALL	MAIN SCREEN

Primary Mode (Continued)

Viewing and Clearing Volume Infused for ALL Channels (Continued)

- Press **CLEAR ALL** soft key.
 - If no key is pressed, main screen appears after 30 seconds.
 - Press **MAIN SCREEN** soft key to return to main screen.

Volume Infused		
	PRI (mL)	SEC (mL)
A	0.0	0.0
B	0.0	0.0
C	0.0	0.0
D	0.0	0.0
>Select Channels to Clear or Press CLEAR ALL		
TOTAL VOLUME	CLEAR ALL	MAIN SCREEN

Viewing and Clearing Volume Infused for Individual Channels

- Press **VOLUME INFUSED** soft key.
 - Total Volume infused (Primary + Secondary), and time and date Volume Infused was last cleared, is displayed for each infusion channel.
 - If no key is pressed, main screen appears after 30 seconds.
 - To view Primary and Secondary volume(s) infused, press **PRI/SEC VOLUME** soft key.

Volume Infused		
	TOTAL VOLUME (mL)	LAST CLEARED
A	401.1	08:00 2002-03-10
B	42.5	07:30 2002-03-11
C	478.1	08:00 2002-03-10
D	789.1	12:00 2002-03-10
>Select Channels to Clear or Press CLEAR ALL		
PRI/SEC VOLUME	CLEAR ALL	MAIN SCREEN

- Press soft key(s) corresponding to channel where volume infused is to be cleared.

Volume Infused		
	TOTAL VOLUME (mL)	LAST CLEARED
A	401.1	08:00 2002-03-10
B	42.5	07:30 2002-03-11
C	478.1	08:00 2002-03-10
D	789.1	12:00 2002-03-10
>Press CLEAR CHANNEL to Clear Selected		
PRI/SEC VOLUME	CLEAR CHANNEL	MAIN SCREEN

- Press **CLEAR CHANNEL** soft key.
 - Selected channel(s) volume is cleared.
 - After 30 seconds, main screen appears.
- Press **MAIN SCREEN** soft key to return to main screen.

Volume Infused		
	TOTAL VOLUME (mL)	LAST CLEARED
A	401.1	08:00 2002-03-10
B	0.0	07:30 2002-03-11
C	478.1	08:00 2002-03-10
D	789.1	12:00 2002-03-10
>Select Channels to Clear or Press CLEAR ALL		
PRI/SEC VOLUME	CLEAR ALL	MAIN SCREEN

Primary Mode (Continued)

AutoRestart

The AutoRestart feature is part of the MEDLEY™ System's Downstream Occlusion Detection system designed to minimize nuisance, patient side occlusion alarms. It allows the system to automatically continue an infusion following detection of a patient side occlusion if downstream pressure falls to an acceptable level within a 15 second "Checking Line" period.

If this feature is enabled, the "Checking Line" function will occur when downstream pressure exceeds the Pressure Limit.

- In Selectable Pressure Mode, the Pressure Limit will be either user adjustable or "locked" in system configuration.
- In Pump Pressure Mode, the Pressure Limit is a function of flow rate and is automatically determined by the device.

If the downstream pressure decreases to a predetermined level, (below 50% of the Pressure Limit) during the 15 second "Checking Line" period, the infusion automatically continues.

If the condition is not cleared within 15 seconds, a "Partial Occlusion - Patient Side" alarm occurs.

Qualified Service personnel can configure the system to allow from zero (0) to nine (9) restart attempts within a rolling 10 minute period. If the allowable number of restarts is exceeded or if the feature is set to zero, an "Occluded - Patient Side" alarm will occur when the system detects downstream pressure over the Pressure Limit.

Secondary Mode

This mode is designed to support automatic secondary infusions (“piggybacking”) in the same instrument channel. When the secondary VTBI reaches zero, a audio tone will sound indicating completion of the secondary infusion. The primary infusion resumes automatically.

When the instrument is programmed and delivering in the secondary mode, the primary infusion is temporarily stopped and fluid is drawn from the secondary container. Delivery from the primary container resumes when the fluid level in the secondary line is level with the fluid in the primary container.

NOTE: Prepare the secondary container and set. Lower the primary container using the hanger included with the secondary set. If a flow sensor is being used, it must be placed on the primary line.

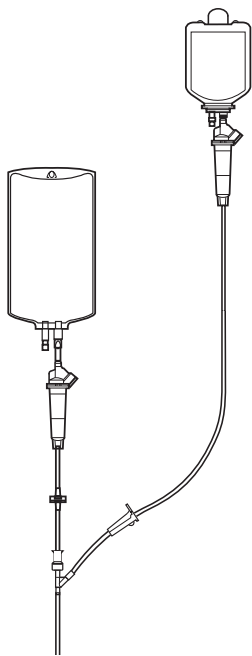

1. Set up and start primary infusion as previously described, using a check valve administration set.
2. Open secondary administration set package, remove set and close clamp.
3. Insert set spike into prepared fluid container and hang secondary container, following accepted hospital procedure.
4. Fill drip chamber to 2/3 full.
5. Open secondary set and prime set. Close clamp.
6. Attach secondary set to upper injection site on primary set.

WARNINGS

- Secondary applications require the use of a check valve set on the primary IV line.
- The secondary solution container must be higher than the primary solution container.
- The secondary VTBI settings require consideration of such variables as factory overfill, medication additions, etc. Underestimating the volume will cause the remaining secondary solution to be infused at the primary rate; overestimating will result in the primary solution being infused at the secondary rate. Multiple doses from a single container are not possible.
- The clamp on the secondary set must be opened. If the clamp is not opened, the fluid will be delivered from the primary container.
- The secondary set must be primed prior to beginning the secondary infusion.

Secondary Mode (Continued)

7. Lower primary fluid container using hanger provided with secondary set.

NOTE: *The secondary container should be at least 9½ inches above the top of the fluid level in the primary container.*

8. Press **CHANNEL SELECT** key on Pump Module.

A Infusion Setup		
RATE		40 mL/h
VTBI		240 mL
>Press START		
PAUSE	SECONDARY	START

9. Press **SECONDARY** soft key.
RESTORE soft key may be pressed to bring back previous secondary infusion parameters from memory (if available).

A Infusion Setup		
SECONDARY		
RATE		_ _ _ mL/h
VTBI		_ _ _ _ _ mL
>Select Rate or Restore Previous Infusion		
RESTORE		

10. Press **RATE** soft key.
11. Enter secondary infusion rate.

A Infusion Setup		
SECONDARY		
RATE		100 mL/h
VTBI		_ _ _ _ _ mL
>Select VTBI		

12. Press **VTBI** soft key.
13. Enter secondary volume-to-be-infused.
14. Open clamp on secondary set.

A Infusion Setup		
SECONDARY		
RATE		100 mL/h
VTBI		_ _ 55 mL
>Press START		
PAUSE	PRIMARY	START

Secondary Mode (Continued)

- Verify correct infusion parameter input and press **START** soft key.
 - Green Infusing Status Indicator illuminates.
 - Channel Rate Display displays secondary rate.
 - Secondary VTBI counts down in Main Display.
 - "SECONDARY" scrolls in Channel Message Display.
 - Upon completion of secondary infusion, switchover alert sounds with six beeps (unless disabled in system configuration), primary rate displays and infusion continues at primary rate.

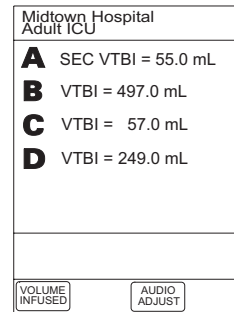

Changing Primary Infusion Parameter During Secondary Infusion

- Press **CHANNEL SELECT** key on Pump Module.

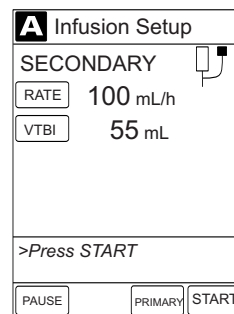

- Press **PRIMARY** soft key on Programming Module.

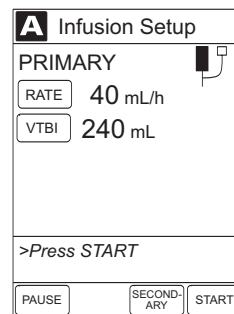

- Press **RATE** soft key.
- Use numeric data entry keys to enter desired primary Flow Rate.

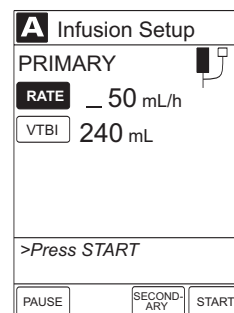

Secondary Mode (Continued)

Changing Primary Infusion Parameter During Secondary Infusion (Continued)

5. Verify correct primary infusion parameter input and press **SECONDARY** soft key to return to secondary setup screen.
6. Press **START** soft key.

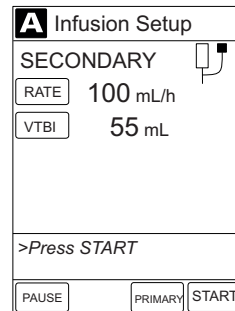

Stopping Secondary Infusion and Returning to Primary Infusion

1. Press **CHANNEL SELECT** key on Pump Module.

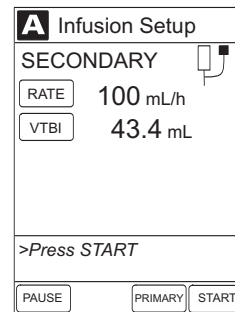

2. Press **PRIMARY** soft key on Programming Module.
3. Close clamp on secondary administration set or disconnect secondary administration set from upper injection port.

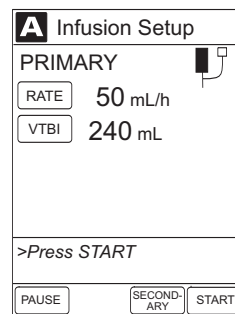

4. Press **START** soft key.
5. Press **Yes** soft key selection to stop secondary infusion and begin infusing primary.
 - Secondary infusion stops and primary infusion begins.
 - Main screen appears.

NOTE: The SEC to PRI alert does NOT sound when the infusion is manually ended and returned to primary.

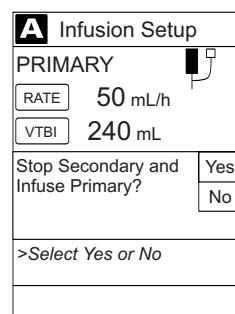

Channel Labels

Selecting Channel Label

1. Press **CHANNEL SELECT** key on desired Pump Module.
2. Press **OPTIONS** key on Programming Module.
3. Press **Channel Labels** soft key.

A Channel Options 1 of 1
Drug Calculation Setup
Pressure Limit - P
Channel Labels
>Select an Option or EXIT
EXIT

4. Press soft key for desired label.
 - Selected label will scroll in Channel Message Display.
 - Use alpha-index speed select and **BACK** soft keys, and/or **PAGE UP** and **PAGE DOWN** soft keys, to view available labels.

A Channel Label Display Adult ICU	
0.9% NaCl	A-E
3% NaCl	F-J
CVVHDF Dialysate	K-O
D5 1/2 NS	P-T
Epidural	U-Z
>Select Channel Label	
EXIT	PAGE DOWN

A Channel Label Display Adult ICU		
Peripheral Art Line	P	
Replacement Solution	Q	
Swan	R	
Triple Lumen	S	
	T	
>Select Channel Label		
PAGE UP	BACK	PAGE DOWN

5. Press **START** soft key or program infusion as previously described.

Channel Labels (Continued)

Removing Channel Label

1. Press **CHANNEL SELECT** key on desired Pump Module.
2. Press **OPTIONS** key on Programming Module.
3. Press **Channel Labels** soft key.

A Channel Options 1 of 1
Drug Calculation Setup
Pressure Limit - P
Channel Labels
>Select an Option or EXIT
EXIT

4. Press **CLEAR LABEL** soft key. Labels stop scrolling.

A Channel Label Display	
Adult ICU	
0.9% NaCl	A-E
3% NaCl	F-J
CVVHDF Dialysate	K-O
D5 1/2 NS	P-T
Epidural	U-Z
>Select Channel Label	
EXIT CLEAR LABEL PAGE DOWN	

5. Press **START** soft key.

A Infusion Setup
RATE 50 mL/h
VTBI 240 mL
>Press START
PAUSE VOLUME DURATION SECONDARY START

Powering Off

Powering Off a Channel

1. Press and hold **CHANNEL OFF** key on channel(s) for one second.

NOTE: *The channel will initiate the power down at the release of the **CHANNEL OFF** key.*

2. Once all attached channels are powered off, Programming Module automatically powers down.
During power off sequence, Main Display flashes “Powering Down”.

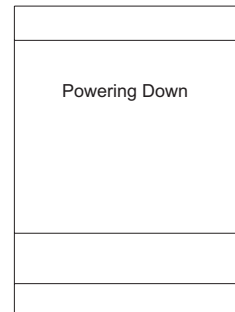

Powering Off the System

Refer to the MEDLEY™ Programming Module (Model 8000) Directions for Use for instructions on Powering Off the System.

Changing Primary Solution Container

1. Press **PAUSE** key on desired Pump Module to stop infusion.
2. Close roller clamp.
3. Remove empty solution container.
4. Spike new container.
5. Press **CHANNEL SELECT** key on desired Pump Module.
6. Press **VTBI** soft key and use numeric data entry keys to enter desired VTBI.
7. Open roller clamp.
8. Press **START** soft key.

Changing and Reloading Set During Infusion

1. Press **PAUSE** key on desired Pump Module to stop infusion.
2. Close roller clamp.
3. Open Pump Module door. Administration set's Flo-Stop® Device will automatically close to prevent accidental free-flow.
4. Remove administration set Flo-Stop® Device first, by gently pulling tubing (below Air-in-Line Detector) forward and out, and then lifting upper fitment vertically from upper fitment recess.

Changing and Reloading Set During Infusion (Continued)

5. Prime and load a new administration set, as described in "Preparing Infusion" section.
6. Close Pump Module door.
7. Press **CHANNEL SELECT** key on desired Pump Module.
8. Press **VTBI** soft key and use numeric data entry keys to enter desired VTBI.
9. Open roller clamp.
10. Press **START** soft key.

Drug Calculation Parameters

The MEDLEY™ System uses the following parameters entered by the user during the drug calculation setup procedure:

- **Bolus dose units:** Units device will use in calculating bolus dose. Bolus dose units are selected, by user, from alternatives provided.
- **Diluent volume:** Volume of fluid used as diluent for drug (mL).
- **Dosing units:** Units device will use in calculating continuous infusion drug dose. Dosing Units are selected, by user, from alternatives provided.
- **Drug amount:** Amount of drug in IV container (gram, mg, mcg, mEq or units).
- **Patient weight:** Weight of patient (kg); this is an optional parameter that is not needed unless drug dose is normalized for patient weight.
- **Time units:** Time base for all calculations (minute or hour).

The bolus dose, drug dose and flow rate parameters are calculated using the above parameters, as follows:

- Bolus dose = Bolus dose x Patient weight (if used).
- Bolus dose duration = Bolus VTBI / Bolus rate.
- Bolus dose VTBI = Bolus dose / Drug concentration.
- Bolus rate = Bolus VTBI / Duration.
- Drug concentration = Drug amount / Diluent volume.
- Drug dose = Flow rate x Drug concentration (normalized for patient weight if specified by entering a patient weight).
- Flow rate = Drug dose / Drug concentration (normalized for patient weight if specified by entering a patient weight).

Setting Up Drug Calculation with Drug Library

To access the Drug Library, a hospital-defined best-practice data set must be uploaded and the Profiles feature enabled.

WARNING

The Drug Calculation feature is to be used only by personnel properly trained in the administration of continuously infused medications. Extreme caution should be exercised to ensure the correct entry of the drug calculation infusion parameters. References in this document to specific drug and drug doses are only examples. Refer to specific drug product labeling for information concerning appropriate administration techniques and dosages.

1. Prime and load set as previously described.
2. Press **CHANNEL SELECT** key on Pump Module.
3. Press **OPTIONS** key on Programming Module.
4. Press **Drug Calculation Setup** soft key.

A Channel Options 1 of 1
Drug Calculation Setup
Pressure Limit - P
Channel Labels
>Select an Option or EXIT
EXIT

5. Press **DRUG LIBRARY** soft key.

A Drug Calculation	
DRUG AMOUNT	mcg
DILUENT VOLUME	mg
PATIENT WEIGHT	gram
TIME UNITS	unit
DOSING UNITS	mEq
>Enter Amount of Drug in Container	
DRUG LIBRARY	

6. Press soft key next to desired drug and concentration.
Use alpha-index speed select, and/or **PAGE UP** and **PAGE DOWN** soft keys, to view available drugs/concentrations.

A Drug Calculation Adult ICU	
aminophylline 500mg/250mL	A-E
bretylum 500 mg/250mL	F-J
dopamine ___mg/___mL	K-O
dopamine 400mg/250mL	P-T
dopamine 800mg/250mL	U-Z
>Select Drug Name	
EXIT	PAGE DOWN

Setting Up Drug Calculation with Drug Library (Continued)

7. Confirm selected drug/concentration is drug to be administered.

- Press **Yes** soft key to continue programming.
- Press **No** soft key to change selection.
- Bolus dose units appear if Bolus Dose is enabled.
- Anesthesia Mode appears if enabled.

A Drug Calculation Adult ICU	
dopamine 400mg in 250mL was selected.	Yes
Is this correct?	No
DOSING UNITS mcg/kg/min NOT BOLUSABLE	
>Press Yes or No	

8. DRUG AMOUNT, DILUENT VOLUME, TIME UNITS and DOSING UNITS are automatically entered for selected drug.

- If hospital practice guidelines identify selected drug as weight-based, system will prompt for a patient weight in kilograms.

NOTE: If a patient's weight has been previously entered, it is automatically displayed. It can be added without affecting the weight-based continuous infusions on this channel.

- If selected drug is not weight-based, system will not permit a patient weight entry.

9. Review drug calculation setup parameter. If setup is correct, press **NEXT** soft key to confirm.

A Drug Calculation dopamine	
DRUG AMOUNT	400 mg
DILUENT VOLUME	250 mL
PATIENT WEIGHT	_ 70 kg
TIME UNITS	Min
DOSING UNITS	mcg/kg/min
[Conc]:	1600 mcg/mL
>Press NEXT to Confirm	
DRUG LIBRARY	NEXT

10. Press either **RATE** or **DOSE** soft key.

A Drug Calculation dopamine	
CONTINUOUS INFUSION	
RATE	___ mL/h
VTBI	_____ mL
DOSE	_____ mcg/kg/min
[Conc]:	1600 mcg/mL
>Select RATE or DOSE	
SETUP	

11. Use numeric data entry keys to enter rate or dose value (other value is calculated and displayed).

NOTE: In the Drug Calculation mode, the device infuses at the calculated rate rounded to the nearest one-hundredth of a mL per hour. The rate shown on the Main Display, Channel Programming screen is this rate. The rate shown in the Channel Rate Display will be rounded to the nearest one-tenth of a mL per hour.

A Drug Calculation dopamine	
CONTINUOUS INFUSION	
RATE	13.1 mL/h
VTBI	_____ mL
DOSE	_____ 5 mcg/kg/min
[Conc]:	1600 mcg/mL
>Select VTBI	
SETUP	

Setting Up Drug Calculation with Drug Library (Continued)

- Press **VTBI** soft key.
- Use numeric data entry keys to enter volume-to-be-infused.

NOTE: At rates less than 10 mL/h, the rate is displayed to two decimal places and the VTBI can be entered and is displayed to two decimal places.

A	Drug Calculation dopamine	
CONTINUOUS INFUSION		
RATE	13.1 mL/h	
VTBI	250 mL	
DOSE	5 mcg/kg/min	
[Conc]: 1600 mcg/mL		
>Press START		
PAUSE	SETUP	START

- Verify drug parameters are correct and then press **START** soft key.

- Rate appears in Channel Rate Display.

NOTE: If a dose outside of the Guardrails® Limits has been entered and verified as correct, the Channel Message Display will also show either "LLL" for a low dose or "↑↑↑" for a high dose.

- Dose and drug name scroll in Channel Message Display.
- Main Display alternates between VTBI and drug name with dose.

Midtown Hospital Adult ICU	
A	VTBI = 250.0 mL
B	
C	
D	
VOLUME INFUSED	AUDIO ADJUST

Setting Up Drug Calculation for Non-Library Drugs

- Prime and load set as previously described.
- Press **CHANNEL SELECT** key on Pump Module.
- Press **OPTIONS** key on Programming Module.

WARNING

The Drug Calculation feature is to be used only by personnel properly trained in the administration of continuously infused medications. Extreme caution should be exercised to ensure the correct entry of the drug calculation infusion parameters. References in this document to specific drug and drug doses are only examples. Refer to specific drug product labeling for information concerning appropriate administration techniques and dosages.

- Press **Drug Calculation Setup** soft key.

A	Drug Calculation
DRUG AMOUNT	mcg
DILUENT VOLUME	mg
PATIENT WEIGHT	gram
TIME UNITS	unit
DOSING UNITS	mEq
>Enter Amount of Drug in Container	
DRUG LIBRARY	

Setting Up Drug Calculation for Non-Library Drugs (Continued)

5. Use numeric data entry keys to enter amount of drug added to IV container.
6. Press soft key for appropriate unit of measure for **DRUG AMOUNT**.

A Drug Calculation	
DRUG AMOUNT	400 mcg
DILUENT VOLUME	mg
PATIENT WEIGHT	gram
TIME UNITS	unit
DOSING UNITS	mEq
>Select Unit of Measure	
DRUG LIBRARY	

7. Use numeric data entry keys to enter diluent volume.

A Drug Calculation	
DRUG AMOUNT	400 mg
DILUENT VOLUME	_250 mL
PATIENT WEIGHT	
TIME UNITS	
DOSING UNITS	
[Conc]: 1600 mcg/mL	
>Select PATIENT WEIGHT	
DRUG LIBRARY	

8. Press **PATIENT WEIGHT** soft key.
9. Press either **Yes** or **No** soft key to indicate whether patient weight is to be used in Drug Calculation.

NOTE: Do not enter a patient weight if weight is not used in the calculation.

A Drug Calculation	
DRUG AMOUNT	400 mg
DILUENT VOLUME	250 mL Yes
PATIENT WEIGHT	> > > No
Note: Press "Yes" only if Patient weight is used in the calculation. For Example: Dosing units = mg/kg/h	
>Use Patient Weight in Calculation?	
DRUG LIBRARY	

10. Use numeric data entry keys to enter patient weight in kilograms (if required) and then press **ENTER**.

A Drug Calculation	
DRUG AMOUNT	400 mg
DILUENT VOLUME	250 mL
PATIENT WEIGHT	_ _70 kg
TIME UNITS	
DOSING UNITS	
[Conc]: 1600 mcg/mL	
>Select Time Units	
DRUG LIBRARY	

11. Press either **Min**, **Hour** or **Day** soft key to select time base for drug calculation.

A Drug Calculation	
DRUG AMOUNT	400 mg
DILUENT VOLUME	250 mL
PATIENT WEIGHT	70 kg Min
TIME UNITS	> > > Hour
DOSING UNITS	Day
[Conc]: 1600 mcg/mL	
>Select Time Units	
DRUG LIBRARY	

Setting Up Drug Calculation for Non-Library Drugs (Continued)

12. Press soft key next to desired DOSING UNITS.

A Drug Calculation	
DRUG AMOUNT	400 mg
DILUENT VOLUME	250 mL
PATIENT WEIGHT	70 kg
TIME UNITS	mcg/kg/min
DOSING UNITS	> > mg/kg/min
[Conc]: 1600 mcg/mL	
>Select the Desired Dosing Units	
DRUG LIBRARY	

13. Verify correct drug calculation infusion parameter input and press NEXT soft key.

A Drug Calculation	
DRUG AMOUNT	400 mg
DILUENT VOLUME	250 mL
PATIENT WEIGHT	70 kg
TIME UNITS	Min
DOSING UNITS	mcg/kg/min
[Conc]: 1600 mcg/mL	
>Press NEXT to Confirm	
DRUG LIBRARY	NEXT

14. Press either RATE or DOSE soft key.

A Drug Calculation	
CONTINUOUS INFUSION	
RATE	___ mL/h
VTBI	_____ mL
DOSE	_____ mcg/kg/min
[Conc]: 1600 mcg/mL	
>Select RATE or DOSE	
SETUP	BOLUS

15. Use numeric data entry keys to enter rate or dose value (other value is calculated and displayed).

NOTE: In the Drug Calculation mode, the device infuses at the calculated rate rounded to the nearest one-hundredth of a mL per hour. The rate shown on the Main Display, Channel Programming screen is this rate. The rate shown in the Channel Rate Display will be rounded to the nearest one-tenth of a mL per hour.

A Drug Calculation	
CONTINUOUS INFUSION	
RATE	13.1 mL/h
VTBI	_____ mL
DOSE	_____ 5 mcg/kg/min
[Conc]: 1600 mcg/mL	
>Select VTBI	
SETUP	BOLUS

Setting Up Drug Calculation for Non-Library Drugs (Continued)

- Press **VTBI** soft key.
- Use numeric data entry keys to enter volume-to-be-infused.

NOTE: At rates less than 10 mL/h, the rate is displayed to two decimal places and the VTBI can be entered and is displayed to two decimal places.

A Drug Calculation	
CONTINUOUS INFUSION	
RATE	13.1 mL/h
VTBI	250 mL
DOSE	5 mcg/kg/min
[Conc]: 1600 mcg/mL	
>Press START	
PAUSE	SETUP
BOLUS	START

- Verify parameters are correct and then press **START** soft key:
 - Rate appears in Channel Rate Display.
 - Dose scrolls in Channel Message Display.
 - VTBI (volume remaining) appears in Main Display.

Midtown Hospital Adult ICU	
A	VTBI = 250.0 mL
B	
C	
D	
VOLUME INFUSED	AUDIO ADJUST

Setting Bolus Dose (Drug Calculation with Drug Library)

This section provides the procedure on how to program a bolus at the beginning of an infusion with a drug calculation programmed using the Drug Library.

NOTE: If Bolus is enabled, the **BOLUS DOSE** soft key will appear in the Drug Calculation screen.

- Set up Drug Calculation as described in “Setting Up Drug Calculation with Drug Library” section, steps 1–13.

A Drug Calculation lidocaine	
CONTINUOUS INFUSION	
RATE	135 mL/h
VTBI	250 mL
DOSE	9 mg/min
[Conc]: 4 mg/mL	
>Press START	
PAUSE	SETUP
BOLUS	START

Setting Bolus Dose (Drug Calculation with Drug Library) (Continued)

- Press **BOLUS** soft key.

NOTE: If the programmed continuous infusion is outside the Guardrails® Limit for that care area, a prompt will appear before the bolus dose can be programmed. If **Yes** soft key is pressed, programming will continue; if **No** soft key is pressed, the infusion will need to be reprogrammed.

A Drug Calculation lidocaine	
Dose exceeds the Guardrail limit of 8 mg/min. Proceed?	Yes
	No
>Press Yes or No	

A Drug Calculation lidocaine	
BOLUS DOSE	
DOSE _____ mg/kg	
PATIENT WEIGHT	
DURATION	
BOLUS VTBI = mL	
[Conc]: 4 mg/mL	
>Enter Bolus Dose	
SETUP	CONTINUOUS

- Use numeric keypad entry keys to enter desired bolus dose. Enter patient weight.
- Press **DURATION** soft key. Press **MAX RATE** soft key to automatically calculate duration or use numeric keypad entry keys to enter desired duration.

NOTE: The **MAX RATE** soft key allows the bolus dose to be programmed to infuse at the maximum rate for that profile. The bolus **DURATION** would be automatically calculated.

A Drug Calculation lidocaine	
BOLUS DOSE	
DOSE 1.00 mg/kg	
PATIENT WEIGHT 70.00 kg	
DURATION 1 min	Max Rate
BOLUS VTBI = 17.5 mL	
[Conc]: 4 mg/mL	
>Press Start to Begin Infusing Bolus Dose	
PAUSE	SETUP CONTINUOUS START

- Press **START** soft key to begin bolus infusion.

Midtown Hospital Adult ICU	
A Bolus VTBI = 17.5 mL	
VOLUME INFUSED	AUDIO ADJUST

Main screen alternates between BOLUS VTBI and drug name with dose.

Midtown Hospital Adult ICU	
A lidocaine 1 mg/kg Bolus	
VOLUME INFUSED	AUDIO ADJUST

Setting Bolus Dose (Drug Calculation with Drug Library) (Continued)

6. During any bolus infusion, press **CHANNEL SELECT** key on Pump Module to see detail screen.

A Drug Calculation lidocaine	
BOLUS DOSE	
Dose	Remaining: 0.085 mg
Pt. Weight: 70 kg	
Time Left: <1 min	Max Rate
BOLUS VTBI = 0.4 mL	
[Conc]: 4 mg/mL	
>Press Start to Continue Infusing Bolus Dose	
PAUSE	STOP BOLUS
START	

7. At conclusion of bolus infusion:
- System beeps twice.
 - "BOLUS DOSE COMPLETE" scrolls in Channel Message Display.
 - Continuous infusion initiates.
 - VTBI counts down in Main Display.

NOTE: During continuous infusion, main screen alternates between VTBI and drug name with dose.

Midtown Hospital Adult ICU	
A VTBI = 241.3 mL	
VOLUME INFUSED	AUDIO ADJUST

Midtown Hospital Adult ICU	
A lidocaine 9 mg/min	
VOLUME INFUSED	AUDIO ADJUST

Setting Bolus Dose (Drug Calculation for Non-Library Drugs)

This section provides the procedure on how to program a bolus at the beginning of an infusion with a drug calculation programmed without the use of the Drug Library.

NOTE: If Bolus is enabled, the **BOLUS DOSE** soft key will appear in the Drug Calculation screen.

1. Set up Drug Calculation as described in "Setting Up Drug Calculation for Non-Library Drugs" section, steps 1–15.

A Drug Calculation	
CONTINUOUS INFUSION	
RATE	13.1 mL/h
VTBI	___ mL
DOSE	___ 5 mcg/kg/min
[Conc]: 1600 mcg/mL	
>Select VTBI	
SETUP	BOLUS

Setting Bolus Dose (Drug Calculation for Non-Library Drugs) (Continued)

- Press **VTBI** soft key.
- Use numeric data entry keys to enter Volume-to-be-Infused.

NOTE: At rates less than 10 mL/h, the rate is displayed to two decimal places and the VTBI can be entered and is displayed to two decimal places.

- Press **BOLUS** soft key.

A Drug Calculation	
CONTINUOUS INFUSION	
RATE	13.1 mL/h
VTBI	250 mL
DOSE	5 mcg/kg/min
[Conc]: 1600 mcg/mL	
>Press START	
PAUSE	SETUP BOLUS START

- Use numeric keypad entry keys to enter desired bolus dose. Press soft key next to desired dosing unit.

NOTE: In this example, **mcg** was selected as the dosing unit so a **PATIENT WEIGHT** entry can not be made.

A Drug Calculation	
BOLUS DOSE	mcg
DOSE	500 mcg/kg
PATIENT WEIGHT	mg
DURATION	mg/kg
BOLUS VTBI =	
[Conc]: 1600 mcg/mL	
>Select the Desired Dosing Units	
SETUP	CONTINUOUS

- Press **MAX RATE** soft key to automatically calculate duration or press **DURATION** soft key and use numeric keypad entry keys to enter desired duration.

NOTE: The **MAX RATE** soft key allows the bolus dose to be programmed to infuse at the maximum rate for that profile. The bolus **DURATION** would be automatically calculated.

- Press **START** soft key to begin bolus infusion.

A Drug Calculation	
BOLUS DOSE	
DOSE	500.0 mcg
PATIENT WEIGHT	Not Used
DURATION	<1 min Max Rate
BOLUS VTBI = 0.313 mL	
[Conc]: 1600 mcg/mL	
>Press Start to Begin Infusing Bolus Dose	
PAUSE	SETUP CONTINUOUS START

BOLUS VTBI counts down on main screen.

Midtown Hospital Adult ICU	
A BOLUS VTBI = 0.3 mL	
VOLUME INFUSED	AUDIO ADJUST

Setting Bolus Dose (Drug Calculation for Non-Library Drugs) (Continued)

8. During any bolus infusion, press **CHANNEL SELECT** key on Pump Module to see detail screen.

A Drug Calculation
BOLUS DOSE
Dose Remaining: 400 mcg
Pt. Weight: Not Used
Time Left: <1 min Max Rate
BOLUS VTBI = 0.25 mL
[Conc]: 1600 mcg/mL
>Press START to Continue Infusing Bolus Dose
PAUSE STOP BOLUS START

9. At conclusion of bolus infusion:
 - System beeps twice.
 - "BOLUS DOSE COMPLETE" scrolls in Channel Message Display.
 - Continuous infusion initiates.
 - VTBI counts down in Main Display.

Midtown Hospital Adult ICU
A VTBI = 249.5 mL
VOLUME INFUSED AUDIO ADJUST

Stopping Bolus Dose

1. Press **CHANNEL SELECT** key on Pump Module.
2. Press **STOP BOLUS** soft key.
3. To stop bolus and start continuous infusion, press **Yes** soft key.
4. To stop continuous infusion, press and hold **CHANNEL OFF** key for 2 seconds.

Restoring Bolus Dose

A bolus dose can be restored after it has completed, either prior to or after the channel has been turned off, as indicated in the following sections.

Bolus Dose Completed - Channel Not Turned Off

1. Press **CHANNEL SELECT** key on Pump Module.
2. Press **BOLUS** soft key.
3. Press **RESTORE** soft key.
4. Verify dosing parameters and press **START** soft key.

Setting Bolus Dose (Drug Calculation for Non-Library Drugs) (Continued)

Restoring Bolus Dose (Continued)

Bolus Dose Completed - Channel Turned Off

1. Press **CHANNEL SELECT** key on Pump Module.
2. Press **RESTORE** soft key.
3. Verify Drug Calculation screen and press **NEXT** soft key.
4. Verify dosing parameters and press **BOLUS** soft key.
5. Press **RESTORE** soft key.
6. Verify dosing parameters and press **START** soft key.

Anesthesia Mode

When the MEDLEY™ System is operating in Anesthesia Mode, a channel can be paused indefinitely without an alarm and the air-in-line limits can be set for up to 500 microliters. Anesthesia Mode also makes it possible to have additional drugs in each profile, which are only accessible when operating in Anesthesia Mode.

NOTE: When the MEDLEY™ System is set up for use in Anesthesia Mode, it is important to select the profile that corresponds with the care area the patient will be taken to when the Anesthesia Mode is discontinued. This will ensure that the MEDLEY™ System will be in the correct profile following the use of the Anesthesia Mode.

Enabling Anesthesia Mode

1. Press **OPTIONS** key on Programming Module.
2. Press **Anesthesia Mode** soft key.

System Options 1 of 2
Display Contrast
Time of Day
Power Down All Channels
Anesthesia Mode
Battery Runtime
>Select an Option or EXIT
EXIT PAGE DOWN

Anesthesia Mode (Continued)

Enabling Anesthesia Mode (Continued)

- Press **Enable** soft key.
- Press **CONFIRM** soft key.

System Options	
Anesthesia Mode	
	Enable
	Disable
Air Detection = 75 microliters	Change
Select an Option or Press CONFIRM	
	CONFIRM

- Press soft key corresponding to channel Anesthesia Mode infusion is to be programmed on.
- Program Anesthesia Mode infusion using same procedure as for any other continuous infusion.

NOTE: In Anesthesia Mode, when a channel with a drug calculation infusion is turned off and then turned back on, pressing the **RESTORE** soft key will bypass the Drug Calculation Setup screen and go directly to the Continuous Infusion screen.

Midtown Hospital Adult ICU	
A	
B	
C	
D	
Anesthesia Mode	
VOLUME INFUSED	AUDIO ADJUST

Disabling Anesthesia Mode

The Anesthesia Mode can be disabled, and normal operation resumed, using either of the following three methods:

- System Options menu.
- Disconnecting system from AC power.
- Connecting system to AC power.

From System Options Menu

- While operating in Anesthesia Mode, press **OPTIONS** key on Programming Module.
- Press **Anesthesia Mode** soft key.

Midtown Hospital Adult ICU	
A	
B	
C	
D	
Anesthesia Mode	
VOLUME INFUSED	AUDIO ADJUST

System Options 1 of 2	
Display Contrast	
Time of Day	
Power Down All Channels	
Anesthesia Mode	
Battery Runtime	
>Select an Option or EXIT	
EXIT	PAGE DOWN

Anesthesia Mode (Continued)

Disabling Anesthesia Mode (Continued)

From System Options Menu (Continued)

- Press **Disable** soft key.
- Press **confirm** soft key. "Anesthesia Mode" is no longer displayed on Main Display, indicating it has been disabled.

System Options	
Anesthesia Mode	
	Enable
	Disable
Air Detection = 75 microliters	
	Change
>Select an Option or Press CONFIRM	
	CONFIRM

Disconnecting System from AC Power While in Anesthesia Mode

- If system is connected to AC power while running in Anesthesia Mode, disconnect system from AC.
 - Anesthesia Mode is automatically disabled.
 - All currently running infusions continue.
 - A prompt appears as an alert that Anesthesia Mode has been discontinued.
- Press **CONFIRM** soft key.

Anesthesia mode was discontinued when AC power cord was disconnected. Press CONFIRM to continue normal operation.	
	CONFIRM

Connecting System to AC Power While in Anesthesia Mode

- Connect system to AC power.
- Press **YES** soft key to continue using Anesthesia Mode while connected to AC power.

AC power cord was connected. Continue ANESTHESIA MODE?	
	Yes
	No
>Select Yes or No	

Reviewing Serial Number

1. Press **OPTIONS** key on Programming Module.
2. Press **Page Down** soft key and then press **Serial Numbers** soft key.
Serial numbers for Programming Module and all attached channels are displayed as shown.
3. Press **EXIT** soft key to return to main screen.

Serial Number Review	
PM:	nnnn-nnnnnnnn
Module A:	nnnn-nnnnnnnn
Module B:	nnnn-nnnnnnnn
Module C:	nnnn-nnnnnnnn
Module D:	nnnn-nnnnnnnn
>Press CANCEL or EXIT	
EXIT	

Reviewing Software Version

1. Press **OPTIONS** key on Programming Module.
2. Press **PAGE DOWN** soft key and then press **Software Versions** soft key.

System Options 2 of 2	
System Configuration	
Serial Numbers	
Software Versions	
Guardrails Event Counter	
>Select an Option or EXIT	
PAGE UP	EXIT

3. Press **View** soft key next to desired channel.
4. Press **EXIT** soft key to return to Software Review screen.
5. Press **EXIT** soft key to return to main screen.

Software Rev. Review	
PM:	View
Module A:	View
Module B:	View
Module C:	View
Module D:	View
>Select an Option or EXIT	
EXIT	

ALARMS, ADVISORIES AND PROMPTS

To enhance safety and ease of operation, the MEDLEY™ System provides a full range of audio and visual alarms, advisories and prompts.

Definitions

Advisory	A sequence of audio and/or visual signals indicating the operating status of the MEDLEY™ Medication Safety System. The audio may be silenced for approximately two minutes by pressing the SILENCE key on the Programming Module.
Alarm	An audio and visual signal that a potentially unsafe condition is present. Immediate action is required. The audio may be silenced for approximately two minutes by pressing the SILENCE key on the Programming Module.
Error	An audio and/or visual signal that a failure has been detected. Immediate action is required.
Guardrails® Advisory	A visual popup requiring a “Yes” or “No” response; designed to help reduce programming errors.
Prompt	An audio and/or visual signal, appearing on the bottom line of the Main Display or the Channel Message Display, to perform some action. The audio may be silenced for twelve seconds by pressing the SILENCE key on the Programming Module.

Audio Characteristics

The Programming Module and Main Display provide four types of alert information: advisories, prompts, alarms, and malfunctions. The characteristics of the accompanying audio sounds are as follows:

Type	Sound	Notes
Advisory	One short beep every two seconds	Variable volume; can be silenced for two minutes.
Alarm	Choice of three alarm audio profiles, selectable in System Configuration	Variable volume; can be silenced for two minutes.
Error (Hardware Detected)	Pairs of long beeps	Fixed maximum decibel volume; cannot be silenced.
Error (Software Detected)	Pairs of long beeps	Fixed maximum decibel volume; can be silenced for two minutes.
Illegal Key Press	Two short beeps	Variable volume; cannot be silenced.
Key Click	One short beep	Fixed minimum volume; can be silenced and disabled in the System Configuration.
Prompt	One short beep every two seconds	Variable volume; can be silenced.
Switchover	Six short beeps	Variable volume; can be silenced and disabled in the System Configuration.

Alarms

Alarm	Meaning	Response
Accumulated Air-in-Line	A large number of air bubbles smaller than current air-in-line limit has recently passed detector.	Clear air from line and press RESET soft key, and then press RESTART key to continue infusion.
Air-in-Line	Air has been detected in set during an infusion. Infusion stops on affected channel.	Ensure tubing is properly installed in Air-in-Line Detector. If air is present, clear air from administration set. Press RESTART key or appropriate CHANNEL SELECT key and then press START soft key.
Channel Disconnected	Channel(s) have either been disconnected while in operation or have a communication problem.	Press CONFIRM soft key to silence alarm and clear message from screen. Reattach channel if desired. If alarm is still present, replace channel with an operable instrument.
Check IV Set	Administration set is not properly installed. Infusion stops on affected channel.	Close roller clamp, remove and reinstall administration set, close door, open roller clamp and then press RESTART key.
Close Door	Door opened during an infusion. Infusion stops on affected channel.	Close door, press RESTART key or appropriate select control and then press START soft key.
Flo-Stop Open - Close Door	The Flo-Stop® Device is in open position while door is open.	Close roller clamp on administration set or close door.
Occluded - Fluid Side/Empty Container	Indicates either upstream occlusion or empty container. Infusion stops on affected channel.	Clear occlusion on fluid side of device. If necessary, refill drip chamber. Press RESTART or CHANNEL SELECT key and then press START soft key.
Occluded - Patient Side	Increased back pressure sensed while infusing in the pump delivery mode. Infusion stops on affected channel.	Clear occlusion, press RESTART key or appropriate select control and then press START soft key.
Partial Occlusion - Patient Side	A partial occlusion of the patient side of IV line has been detected by the AutoRestart feature.	Clear occlusion, press RESTART key or appropriate select control and then press START soft key.
Restart Channel	Door was opened during an infusion and then closed. Infusion stops on affected channel.	Close door, press RESTART key or appropriate channel select control and then press START soft key.

Advisories

Advisory	Meaning	Response
Anesthesia Mode	Anesthesia Mode has been enabled.	None
Bolus Dose Complete	Channel is running in continuous infusion mode if programmed.	None
Checking Line	A patient side occlusion has occurred and AutoRestart feature is monitoring downstream pressure to determine if infusion can continue.	None
Infusion Complete - KVO	Programmed volume-to-be-infused has been delivered; channel is running at KVO rate.	Set up a new infusion or press CHANNEL OFF key.
Panel Locked	Occurs following a key press when Tamper Resist feature is active.	If appropriate, deactivate Tamper Resist feature using Tamper Resist Control on back of Programming Module.
Panel Unlocked	Occurs when Tamper Resist feature is deactivated.	None.
Pause	Pause control has been pressed; infusion is stopped.	To resume infusion, press RESTART key, or press CHANNEL SELECT key and then press START soft key.
Secondary	A secondary infusion is in progress on indicated channel.	None. When secondary VTBI="0", infusion will revert to programmed primary parameters.

Errors

Error	Meaning	Response
Channel Error	System has detected an error on a pumping channel. Infusion stops on affected channel.	Press CONFIRM soft key to silence alarm and continue operation of unaffected channels. Replace Pump Module with an operational unit as required. Service by qualified personnel is required.

THIS PAGE
INTENTIONALLY
LEFT BLANK

The MEDLEY™ System Technical Service Manual is available from ALARIS Medical Systems and includes routine service schedules, circuit diagrams, component parts lists and descriptions, calibration and test procedures, and other technical information, to assist qualified service personnel in repair and maintenance of the instrument's repairable components. Maintenance procedures are intended to be performed only by qualified personnel.

Specifications

Accumulated Air Window:	Single Bolus Setting	Volume Window (mL)	% Air that Causes Alarm
	50	2.8	10%
	75	8.0	20%
	250	8.0	30%
	*500	12.0	30%

* In Anesthesia Mode only.

Bolus Volume following Occlusion, Maximum:	Pressure Limit (mmHg)	
	Rate (mL/h)	
	25	≤0.3 mL
		≤0.6 mL

Critical Volume: The maximum over-infusion which can occur in the event of a single fault condition is 0.6 mL.

Dimensions: 3.3"W x 8.9"H x 5.5"D

Environmental Conditions:	Operating	Storage/Transport
<i>Temperature Range:</i>	41 to 104°F (5 to 40°C)	-4 to 140°F (-20 to 60°C)
<i>Relative Humidity:</i> (Avoid prolonged exposure to relative humidity >85%)	20 to 90% Noncondensing	5 to 85% Noncondensing
<i>Atmospheric Pressure:</i>	525 to 4560 mmHg (700 to 6080 hPa)	375 to 760 mmHg (500 to 1013 hPa)

Equipment Orientation: To ensure proper operation, the system must remain in an upright position.

Electrical Classification: Class 1, Type CF Defibrillator Proof

Flow Rate Programming Increments:	Rate Range (mL/h)	Increments (mL/h)	
		User Input Rates	Device Calculated Rates
	0.1 - 9.99	0.1	0.01
	10 - 99.9		0.1
	100 - 999	1	1

Fluid Ingress Protection: IPX1, Drip Proof

Specifications (Continued)

Infusion of Air, Means to Protect Patient from:	Ultrasonic Air-in-Line Detection Maximum single bolus size = selectable 50, 75 or 250 microliters nominal (500 microliters in Anesthesia Mode)
Infusion Pressure, Maximum:	683 mmHg
KVO (Keep Vein Open) Rate:	Factory Default Setting is 1.0 mL/h if set rate is 1.0 mL/h or above; or set rate, if rate is 0.9 mL/h or below.
KVO Selection Range:	KVO rate can be set in System Configuration from 0.1-20 mL/h in 0.1 mL/h increments.
Occlusion Alarm Thresholds:	
<i>Pump Mode:</i>	525 mmHg at rates ≥ 30 mL/h Varying level based on rate and patient back-pressure at rates < 30 mL/h.
<i>Selectable Mode:</i>	User selected from 50 to 525 mmHg in 25 mmHg increments.
Operating Principle:	Positive displacement
Rate Accuracy:	Rate accuracy of the MEDLEY™ Medication Safety System is $\pm 5\%$ at rates between 1.0 and 999 mL/h and $\pm 5.5\%$ at rates < 1.0 mL/h, 95% of the time with 95% confidence, under the conditions listed below. (Refer to the Trumpet and Start-Up Curves for additional information.)
Infusion Rate Range:	0.1 to 999 mL/h
Ambient Temperature:	$68 \pm 4^{\circ}\text{F}$ ($20 \pm 2^{\circ}\text{C}$)
Source Container Height:	20 inches above the top of the Pump Module
Test Solution:	Distilled Water
Distal Back pressure:	0 mmHg (0 kPa)
Needle:	18 gauge
Set Model	2210

WARNING

Variations of head height, back pressure or any combination of these may affect rate accuracy. Factors that can influence head height and back pressure are: IV set configuration, IV solution viscosity and IV solution temperature. Back pressure may also be affected by type of catheter. Refer to the "APPENDIX – Trumpet and Start-Up Curves" for data on how these factors influence rate accuracy.

Time to Alarm, Maximum:

Rate (mL/h)	Pressure Limit (mmHg)	
	50	525
1	≤ 5 minutes	≤ 45 minutes
25	≤ 15 seconds	≤ 2 minutes

Specifications (Continued)

Volume to be Infused
Programming Increments:

Range (mL)	Increments (mL)
0.1 - 9.99	0.01
10 - 999.9	0.1
1000 - 9999	1

Weight: 2.5 lbs

NOTE: *Compliance to Standards*

The MEDLEY™ Medication Safety System has been assessed and complies with the following standards: UL 2601-1, including A1 and A2; CSA C22.2 No. 601.1, including A1 and A2; IEC/EN 60601-2-24; IEC/EN 60601-1-2, and AAMI ID26.

Configurable Settings

NOTE: *With the Profiles feature enabled, the settings are configured independently for each profile. A hospital-defined, best-practice data set must be uploaded to enable the Profiles feature. Date and Time is a system setting and is the same in all profiles.*

System Settings

Feature	Default Setting	Options
Alarm Audio	Profile 1	Profile 1, 2 or 3
Anesthesia Mode	Disabled	Enabled - Disabled
Battery Meter	Disabled	Enabled - Disabled
Clock Setup (Date and Time)	N/A	Set date and time
Key Click Audio	Enabled	Enabled - Disabled
Max Patient Weight	500 kg	0.1 - 500 kg
Tamper Resist	Disabled	Enabled - Disabled

Configurable Settings (Continued)

Pump Module Settings

Feature	Default Setting	Options
Accumulated Air-in-Line	Enabled	Enabled - Disabled
Air-in-Line Settings (<i>single bolus</i>)	75 microliters	50, 75 or 250 microliters Anesthesia Mode only: 500 microliters
AutoRestart Attempts	0	0-9 attempts Anesthesia Mode only: 9 attempts
Drug Calculation	Disabled	Enabled - Disabled
• Bolus Dose	Disabled	Enabled - Disabled
KVO Rate Adjust (<i>"Keep Vein Open"</i>)	1 mL/h	0.1 - 20 mL/h
Max Rate	999 mL/h	0.1-999 mL/h in 0.1 mL/h increments to 99.9, then 1.0 mL/h increments from 100 to 999 mL/h.
Max VTBI	9999 mL	0.1-9999 mL
Pressure Dynamic (<i>"Dynamic Pressure Display"</i>)	Disabled	Enabled - Disabled
Pressure Mode	Pump (P); Unlocked	Pump (P), Selectable (S); Locked or Unlocked
Profiles	Disabled	Enabled - Disabled
SEC to PRI Alert	Enabled	Enabled - Disabled
Secondary (<i>"Dual Rate Sequential Piggybacking"</i>)	Disabled	Enabled - Disabled
Volume/Duration Infusion	Disabled	Enabled - Disabled

Check-In and Configuration

Refer to the MEDLEY™ Programming Module (Model 8000)
Directions for Use.

Cleaning

Refer to the MEDLEY™ Programming Module (Model 8000)
Directions for Use.

Inspection Requirements

To ensure the system remains in good operating condition, both regular and periodic inspections are required.

Regular inspections consist of a visual inspection for damage and cleanliness, and performing the procedure described in the Start-Up Sequence section of this directions for use before each usage of the instrument. Regular inspections are not covered under any contract or agreement offered by ALARIS Medical Systems and must be performed by the user.

WARNING

Failure to perform these inspections may result in improper instrument operation.

REGULAR INSPECTIONS

PROCEDURE	FREQUENCY
INSPECT FOR DAMAGE:	
Enclosure	Each usage
I/O Connector	Each usage
CLEANING	As required
START-UP SEQUENCE	Each usage

Periodic inspections of the hardware are required. For detailed instructions on performing periodic inspections and maintenance, refer to the MEDLEY™ Technical Service Manual and supplemental service bulletins. A service agreement may be obtained from ALARIS Medical Systems for the performance of all required periodic inspections.

NOTE: *Periodic inspections should only be performed by qualified service personnel.*

Service Information

Refer to the MEDLEY™ Programming Module (Model 8000) Directions for Use.

WARRANTY

ALARIS Medical Systems, Inc., (hereinafter referred to as "ALARIS Medical Systems") warrants that:

- A. Each new ALARIS Medical Systems MEDLEY™ Medication Safety System is free from defects in material and workmanship under normal use and service for a period of one (1) year from the date of delivery by ALARIS Medical Systems to the original purchaser.
- B. The main battery and each new accessory is free from defects in material and workmanship under normal use and service for a period of ninety (90) days from the date of delivery by ALARIS Medical Systems to the original purchaser.

If any product requires service during the applicable warranty period, the purchaser should communicate directly with the relevant account representative to determine the appropriate repair facility. Except as provided otherwise in this warranty, repair or replacement will be carried out at ALARIS Medical Systems' expense. The product requiring service should be returned promptly, properly packaged and postage prepaid by purchaser. Loss or damage in return shipment to the repair facility shall be at purchaser's risk.

In no event shall ALARIS Medical Systems be liable for any incidental, indirect or consequential damages in connection with the purchase or use of any ALARIS Medical Systems product. This warranty shall apply solely to the original purchaser. This warranty shall not apply to any subsequent owner or holder of the product. Furthermore, this warranty shall not apply to, and ALARIS Medical Systems shall not be responsible for, any loss or damage arising in connection with the purchase or use of any ALARIS Medical Systems product which has been:

- (a) repaired by anyone other than an authorized ALARIS Medical Systems service representative;
- (b) altered in any way so as to affect, in ALARIS Medical Systems' judgment, the product's stability or reliability;
- (c) subjected to misuse or negligence or accident, or which has had the product's serial or lot number altered, effaced or removed;

or

- (d) improperly maintained or used in any manner other than in accordance with the written instructions furnished by ALARIS Medical Systems.

This warranty is in lieu of all other warranties, express or implied, and of all other obligations or liabilities of ALARIS Medical Systems, and ALARIS Medical Systems does not give or grant, directly or indirectly, the authority to any representative or other person to assume on behalf of ALARIS Medical Systems any other liability in connection with the sale or use of ALARIS Medical Systems products.

ALARIS Medical Systems DISCLAIMS ALL OTHER WARRANTIES, EXPRESS OR IMPLIED, INCLUDING ANY WARRANTY OF MERCHANTABILITY OR OF FITNESS FOR A PARTICULAR PURPOSE OR APPLICATION.

See packing inserts for international warranty, if applicable.

Trumpet and Start-Up Curves

DESCRIPTION AND EXPLANATION OF TRUMPET AND START-UP CURVES

In this instrument, as with all infusion systems, the action of the pumping mechanism and variations in individual administration sets cause short-term fluctuations in rate accuracy. The following graphs show typical performance of the system for both Pressure and Resistance Modes in two ways:

1. Accuracy during various time periods over which fluid delivery is measured (trumpet curves).
2. Delay in onset of fluid flow when infusion commences (start-up curves).

Trumpet curves are named for their characteristic shape. They display discrete accuracy data averaged over particular time periods or "observation windows", not continuous data versus operating time.

Over long observation windows, short-term fluctuations have little effect on accuracy, as represented by the flat part of the curve. As the observation window is reduced, short-term fluctuations have greater effect, as represented by the "mouth" of the trumpet. Knowledge of system accuracy over various observation windows may be of interest when certain drugs are being administered.

Because the clinical impact of short-term fluctuations on rate accuracy depends on the half-life of the drug being infused and on the degree of intravascular integration, the clinical effect cannot be determined from the trumpet curves alone. Knowledge of the start-up characteristics should also be considered.

The start-up curves represent continuous flow rate versus operating time for two hours from the start of the infusion. They exhibit the delay in onset of delivery due to mechanical compliance and provide a visual representation of uniformity. Trumpet curves are derived from the second hour of this data.

FLOW CHARACTERISTICS UNDER VARYING DELIVERY CONDITIONS

Effects of Pressure Variations

Under conditions of +100 mmHg pressure, the MEDLEY™ Pump Module typically exhibits a long-term accuracy offset of approximately -0.7% from mean values.

Under conditions of +300 mmHg pressure, the MEDLEY™ Pump Module typically exhibits a long-term accuracy offset of approximately -4.2% from mean values.

Under conditions of -100 mmHg pressure, the MEDLEY™ Pump Module typically exhibits a long-term accuracy offset of approximately +4.4% from mean values.

Resulting trumpet observation points typically track those of accuracy; therefore, no significant change in short-term variations result under these pressure conditions.

Effects of Negative Solution Container Heights

With a negative head height of -0.5 meters, the MEDLEY™ Pump Module typically exhibits a long-term accuracy offset of approximately -3.1% from mean values.

Resulting trumpet observation points typically track those of accuracy; therefore, no significant change in short-term variations result under negative head height conditions.

NOTE: Tests conducted in accordance with IEC/EN 60601-2-24, "Particular requirements for safety of infusion pumps and controllers" and AAMI ID26-1998 "Medical electrical equipment - Part 2: Particular requirements for the safety of infusion pumps and controllers", using MEDLEY™ / Gemini Model 2210 Administration Sets.

Trumpet and Start-Up Curves (Continued)

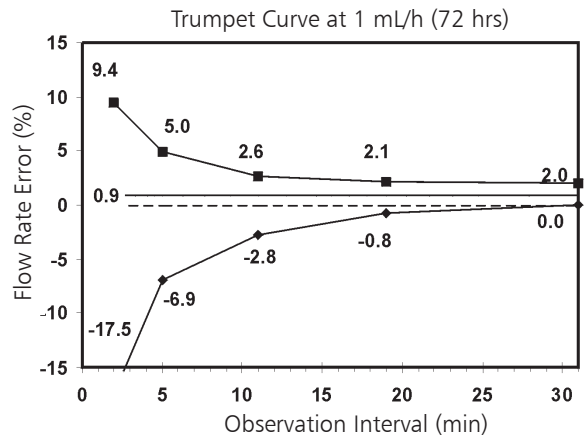
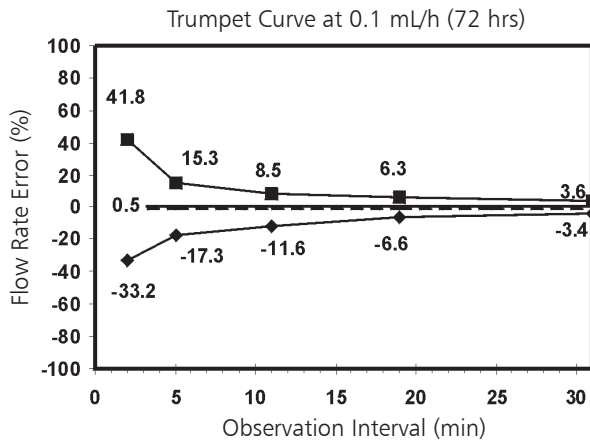
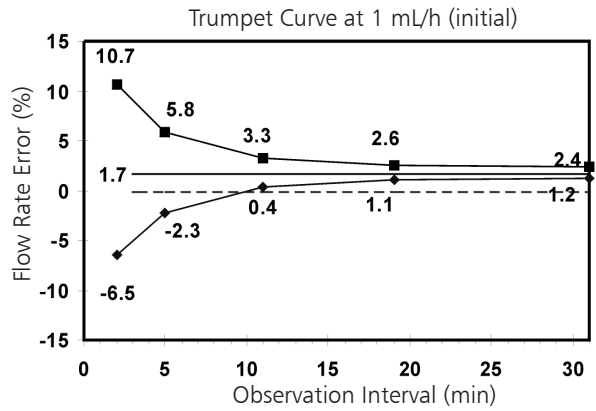
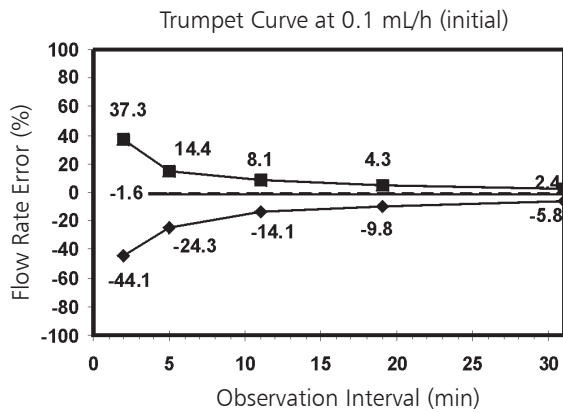
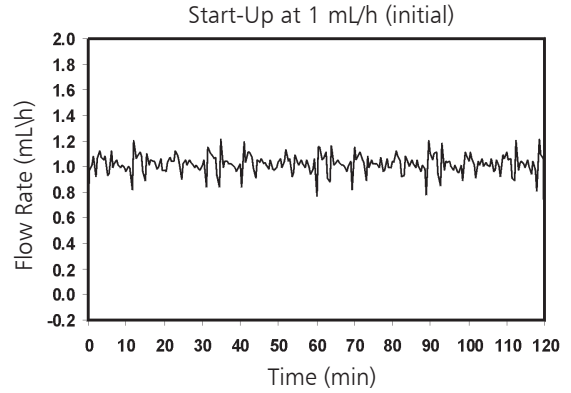
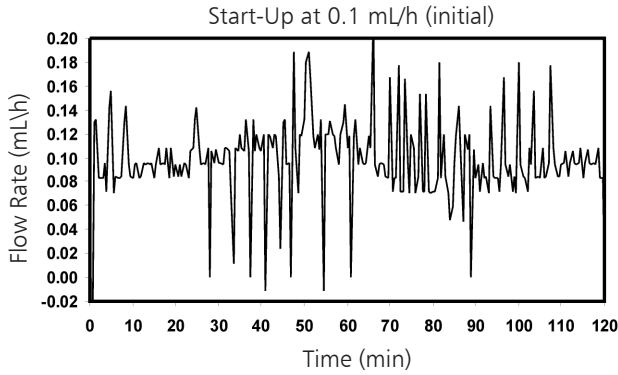

NOTE: The plot range has been increased to $\pm 100\%$, to allow visualization of the graph.

Legend:

- Maximum rate error
- Overall rate error
- ◆ Minimum rate error

Trumpet and Start-Up Curves (Continued)

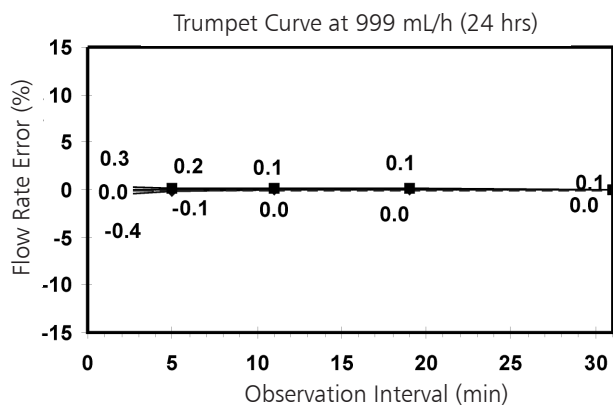
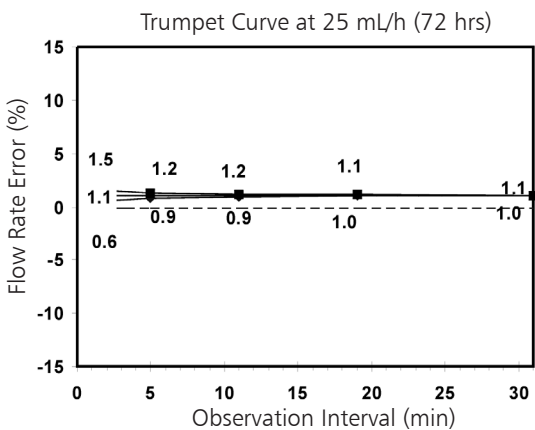
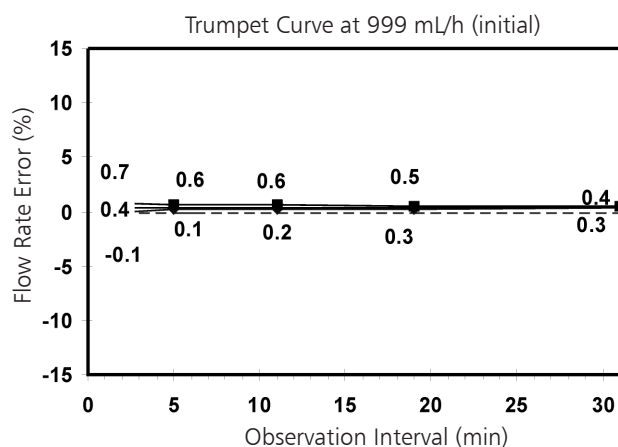
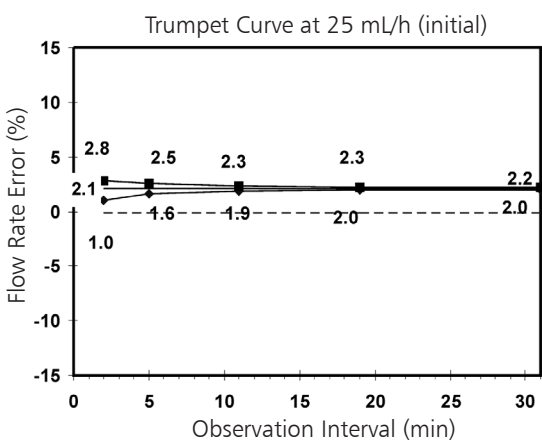
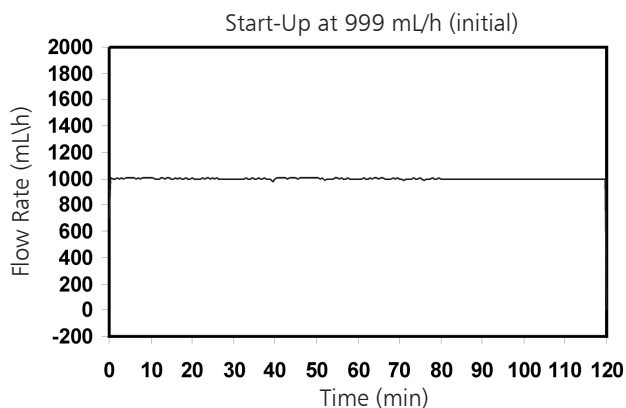
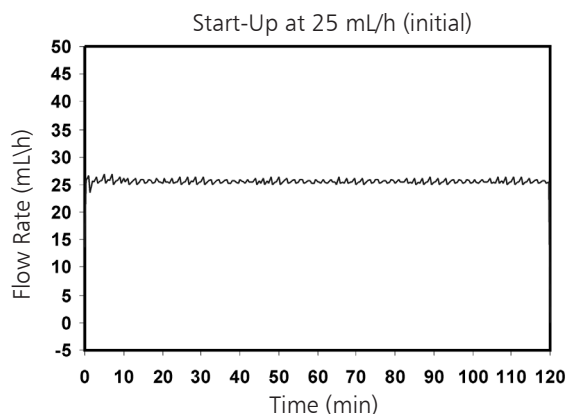

Legend:
 Maximum rate error
 Overall rate error
 Minimum rate error

THIS PAGE
INTENTIONALLY
LEFT BLANK



To Purchase, Visit Avobus.com or call [1-800-674-3655](tel:1-800-674-3655)



ALARIS Medical Systems, Inc.
10221 Wateridge Circle
San Diego, California 92121 U.S.A.

Mail:
P.O. Box 85335
San Diego, California 92186-5335 U.S.A.

ALARIS®, ALARIS Medical Systems®, Flo-Stop®, Guardrails®, MEDLEY™, and SmartSite® are trademarks and registered trademarks of ALARIS Medical Systems, Inc.

All other trademarks belong to their respective owners.

US Pat. Nos. 4,764,166; 4,690,673; 5,165,873; 5,601,445; 5,713,856; 5,781,442; 5,800,387; 5,836,910; 5,941,846; 6,347,553; AU Patent Nos. 634,811; 693,662; 703,178; 703,203; 719,254; 728,366; AT 0,225,158; BE Brevet Belge No. 0,225,158; CA Patented/Breveté 1,258,212; 2,026,518; CH +0,225,158; DE D.B.P. Nos. 0,422,855; P3686558.3; FR Brevet Nos. 0,225,158; 0,422,855; GB Patent Nos. 0,225,158; 0,422,855; IT Brevettato Vol. R.A. No. 0,225,158; JP Patent Nos. 特許第 1,816,872 号; 特許第 2,594,604 号; NL Ned. Octrooi No. 0,225,158; SE Sv. pat. nr 0,225,158; TW Patent No. NI-107963. Other Patents Pending.