

# MedSystem III<sup>®</sup>

Multi-Channel Infusion Pump with  
Advanced Dose Rate Calculation

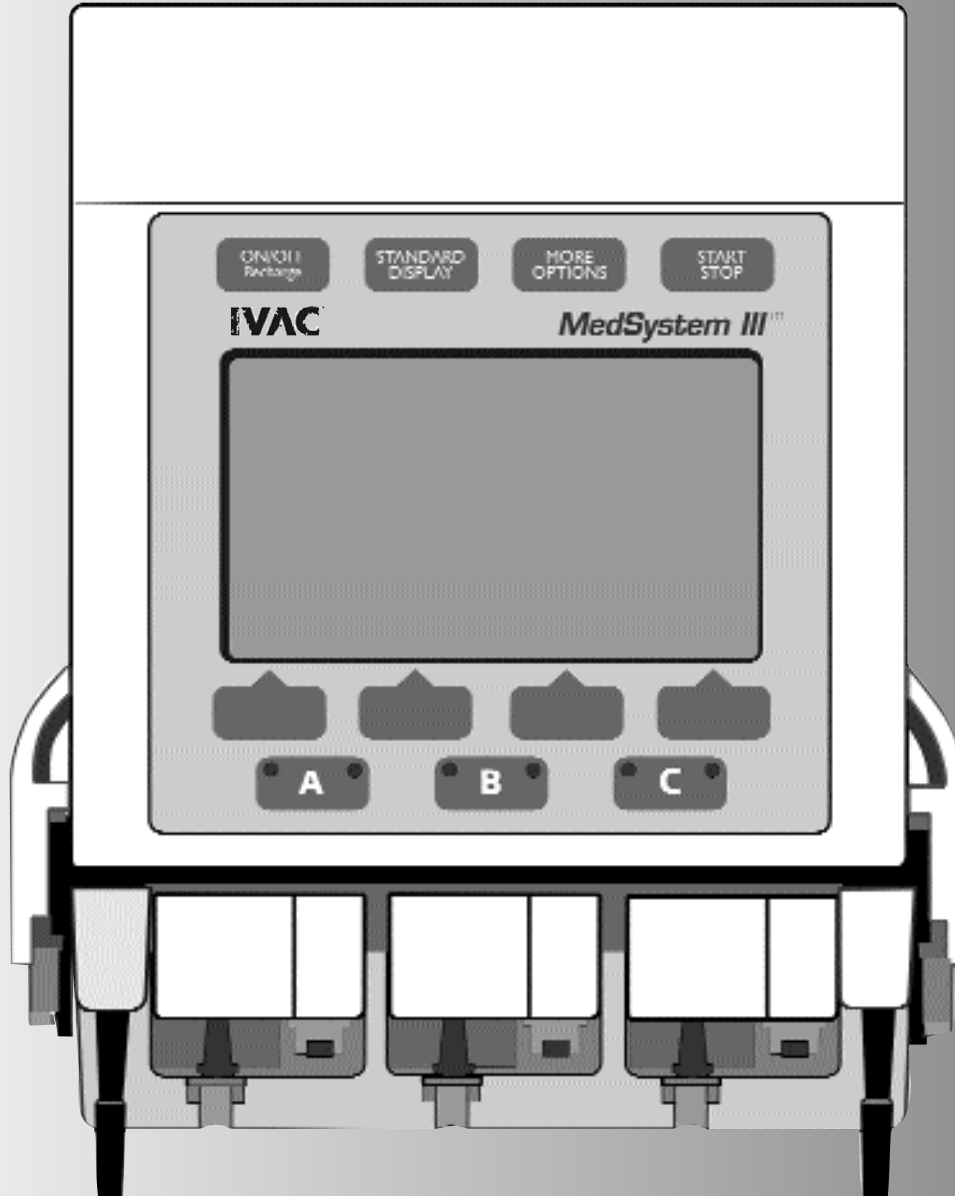

**DIRECTIONS FOR USE**

# TABLE OF CONTENTS

INTRODUCTION		
ABOUT THE PUMP .....	1	INTRODUCTION
FEATURES.....	2	
SYSTEM COMPONENTS .....	4	
OPERATIONAL PRECAUTIONS .....	6	
BASIC OPERATION		
PREPARING THE INFUSION .....	9	BASIC OPERATION
PREPARING THE ADMINISTRATION SET .....	9	
LOADING THE SET .....	9	
FRONT PANEL OVERVIEW .....	10	
PROGRAMMING PRIMARY INFUSION .....	14	
MAKING CHANGES WHILE INFUSING .....	15	
KVO STATUS.....	17	
ADVANCED OPERATION		
SECONDARY MODE .....	19	ADVANCED OPERATION
PREPARING THE ADMINISTRATION SET .....	19	
PROGRAMMING SECONDARY INFUSION.....	20	
DOSE RATE CALCULATOR (DRC) USING A SPECIFIC DRUG NAME.....	22	
DOSE RATE CALCULATOR PROGRAMMING WITH DRUG? .....	24	
DEVICE .....	26	
CONFIG .....	28	
NOTE .....	29	
BATLOG.....	29	
TROUBLESHOOTING		
RESPONDING TO AN ADVISORY, ALARM OR FAULT .....	31	TROUBLESHOOTING
ALARM RESPONSE KEYS .....	31	
ADVISORIES .....	32	
ALARMS.....	33	
FAULT .....	36	
WATCHDOG.....	36	
OTHER CONDITIONS.....	36	
MAINTENANCE		
SPECIFICATIONS .....	37	MAINTENANCE
CLEANING .....	38	
INSPECTION REQUIREMENTS .....	41	
SERVICE INFORMATION .....	42	
WARRANTY .....	43	
GLOSSARY.....	44	

**CAUTION:** *With any multiple or parallel infusions (i.e., connection of additional infusion systems to the MedSystem III pump and connection to the patient venous system), air infusion, reverse flow, and flow interruption are possible. Please consult the "Overall Problem/Solution Matrix" contained in DIN/VDE Standard 0753 in such cases.*

**WARNING:** *The use of positive displacement infusion devices ported together with gravity flow infusion systems into a common IV site may impede the flow of common "gravity only" systems affecting their performance (hospital personnel must ensure the performance of the common IV site is satisfactory under these circumstances).*

**WARNING:** *The pump is designed to stop fluid flow under alarm conditions other than the Low Battery and KVO. Periodic patient monitoring must be performed to ensure infusion is proceeding as expected.*

**WARNING:** *The MedSystem III is a positive pressure delivery system capable of developing positive fluid pressures to overcome widely varying resistances to flow. It is neither designed nor intended to detect infiltrations and will not alarm under infiltration conditions.*

**WARNING:** *Hospital personnel must ensure the compatibility of the drugs as well as the performance of each pump as part of the overall infusion. Potential hazards include drug interactions, inaccurate delivery rates, inaccurate pressure alarms, and nuisance alarms.*

**CAUTION:** *Only systems that have been qualified to International Standard IEC 60601-1 should be connected to the Communications Receptacle, and the connection should ONLY be performed by qualified personnel. The selection, testing, and use of host computer hardware and software, in conjunction with the MedSystem III pump is strictly the responsibility of the purchaser.*

## About the Pump

The MedSystem III® Multi-Channel Infusion Pump —

- three independent fluid delivery systems in the space of one.
- compact size:
  - reduces bedside clutter
  - simplifies patient transport
- easy to setup and use, yet provides advanced features.
- accurate delivery of a variety of fluids.
- accommodates assorted container types.
- multiple delivery methods:
  - Intravenous/Intra-arterial/Subcutaneous/Epidural
- Uses administration sets that provide free flow protection.
- Six available Device Types with configurable parameters (maximum and minimum rates, maximum volumes, baseline and maximum pressures, and air-in-line thresholds) to achieve specific clinical applications:
  - General Purpose
  - Neonatal
  - Controller Pressure
  - Operating Room
  - General Purpose II
  - Operating Room II
- Displays infusion status for rate, volume remaining and volume infused.
- Infusions can be programmed to deliver at a specified rate or over a specified period of time.
- Secondary mode allows fluids and medications to be delivered at two different rates, sequentially.
- Dose Rate Calculator (DRC) feature performs the volumetric rate and/or dose rate calculations.
- With DRC activated, displays infusion status for rate, dosing regimen and drug name.
- Communications Protocol allows clinical monitoring, instrument configuration and maintenance.
- Field Maintenance software (FMS) available for Biomed to configure, service and troubleshoot the pump.

## Features

### Multi-channel Fluid Delivery System

The instrument combines three independent infusion channels in an unparalleled small size.

### Lightweight/portable

The pump with pole clamp weighs just over 5 pounds and is easy to transport.

### Unique, rotating pole clamp

The Pump may be attached to a variety of surfaces.

### Dose Rate Calculator (DRC)

The pump calculates a volumetric or dose rate based on values entered for patient weight, drug concentration (*drug amount and diluent volume*) and dosing parameters.

### Six Device Types available

General Purpose, Neonatal, Controller Pressure, Operating Room, General Purpose II, and Operating Room II.

### Free-flow Protection

The IVAC 28 and 25 Series Administration Sets contain a cassette that provides protection from free-flow conditions. To remove the cassette from the pump, the cassette's slide clamp is pulled to full extension, occluding the tubing and preventing fluid from flowing.

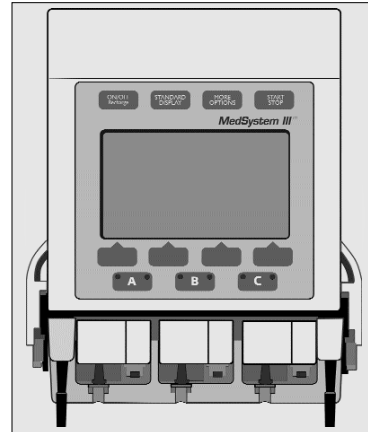

A:	Stopped		
<b>DRUG?</b>	Wt	----	KG= 0.0 LB
A:Conc	-----	mg/----	ml
A:Dose	-----	mcg/kg/min	
A:Rate	-----	ml/h	
A:VR	1	ml (Vol Rem)	
A:VI	0 ml	DI	0.0 mg
Press Select to choose line			
Select	↑	↓	Clear

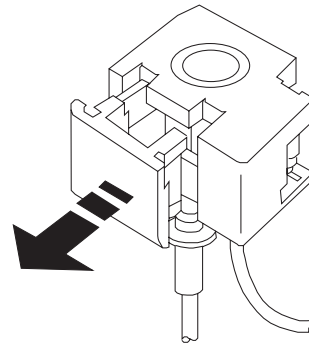

**Monitoring System**

The instrument continuously monitors pump conditions and alerts with adjustable audio tones and visual messages.

**Data Monitoring**

The pump can be configured to communicate with a remote computer, such as a centralized patient monitoring nurses station. The COMM receptacle is compatible with RS-232 cabling. A communications manual that describes the programming and hardware involved is available.

**Field Maintenance Software (FMS)**

The pump can be modified to accommodate specialized clinical applications. The Device Type parameters, occlusion limit, and air-in-line threshold can be reconfigured with the optional FMS software.

**Secondary Mode**

Allows the user to program two different rates of infusion to run sequentially.

**Full Range of Delivery Rates**

Rates from 0.1 to 999 milliliters an hour.

**Battery Capacity**

A fully-charged battery provides 6 to 8 hours of operating time with rates at 125 ml/h per channel.

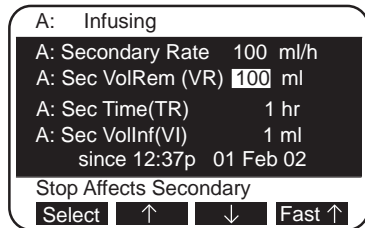
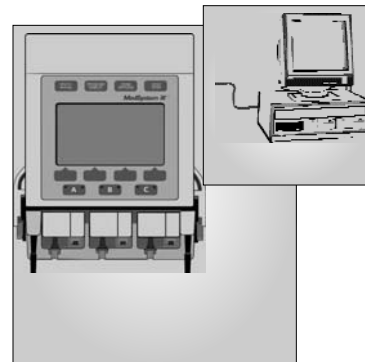

# System Components

## Front Panel

- Instrument Keys
- Display Screen
- Softkey Pads
- Channel Indicator Lights
  - Green:
    - Steady - infusing on AC power
    - Flashing - infusing on battery power
  - Red:
    - Slow flashing - Advisory
    - Rapid flashing - Alert
- Channel Select Keys

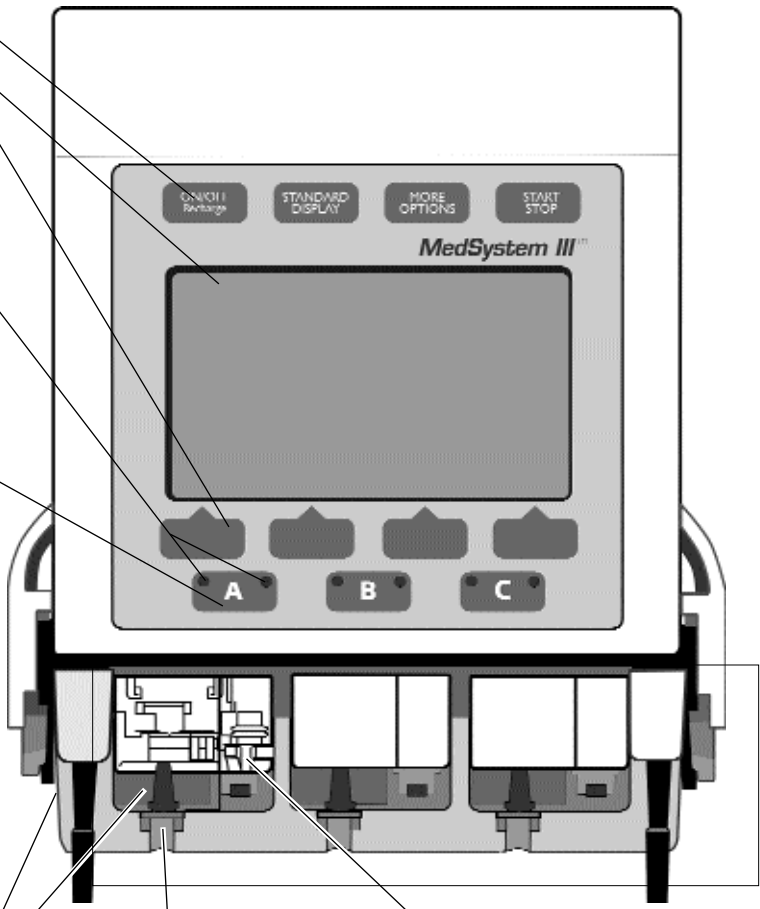

## Cassette

Portion of administration set, inserts into cassette holder.

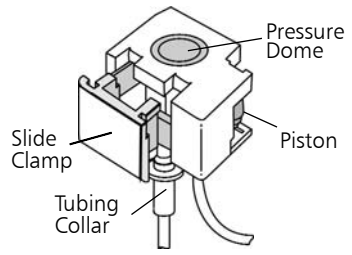

## Lower Assembly

3 Cassette Holders

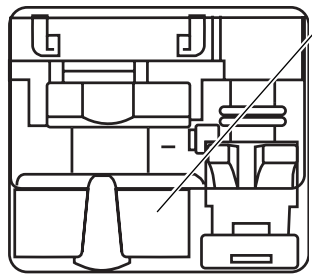

*Air-in-Line Sensor*

Detects bubbles of air during infusion.

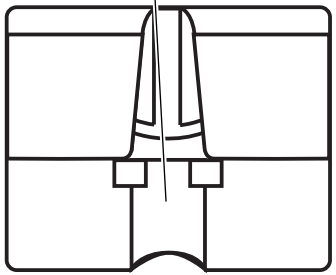

*Tubing Collar Recess*

Holds tubing collar in place.

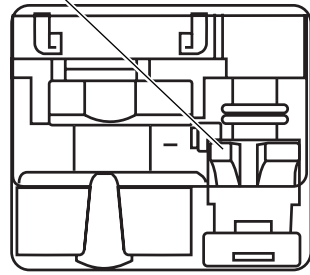

*Pump Latch Mechanism*

Drives the cassette piston to move fluid through the tubing.

### Connector Panel

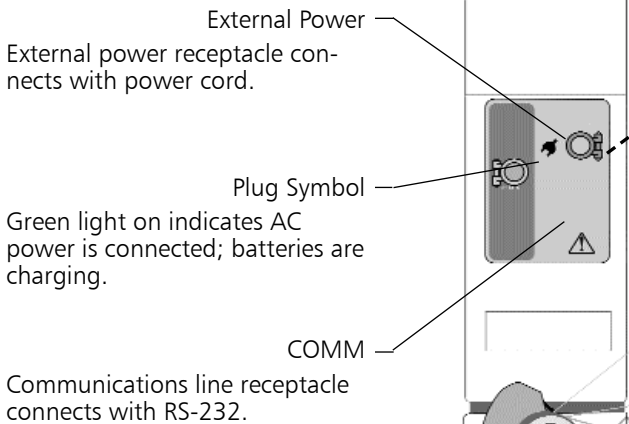

External Power  
External power receptacle connects with power cord.

Plug Symbol  
Green light on indicates AC power is connected; batteries are charging.

COMM  
Communications line receptacle connects with RS-232.

AC Adapter Power Cord  
120V/60 Hz three-pronged grounded adapter with 4 pin locking connector, standard on Model 2863.

**NOTE:** When inserting or removing connectors to the receptacles, avoid excessive force or twisting.

Container Hook  
One hook on each side of the instrument.

Rotating Latch  
Allows clamp to spin 360° and position at every 90°.

Adjustable Pole Clamp  
Jaw with clutch feature, mounts pump to a pole or bedside.

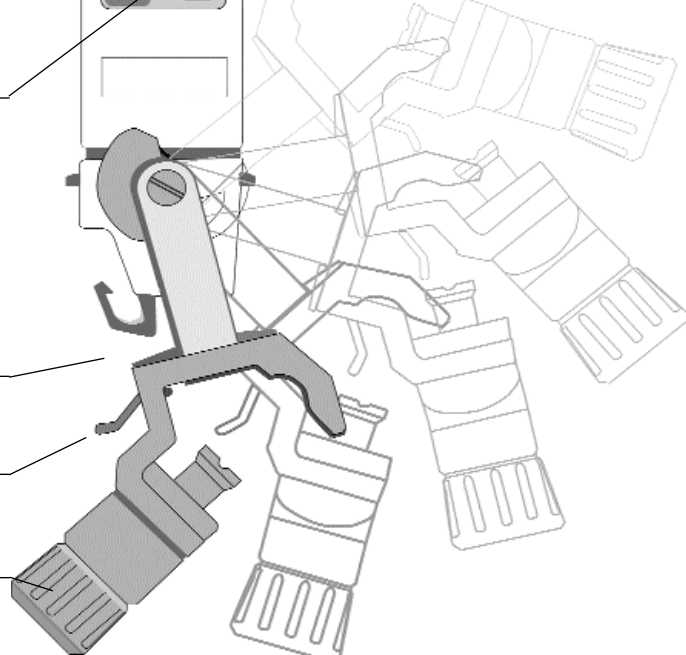

### Attaching Pole Clamp

To attach the pole clamp, position the clamp jaw over the mounting surface and turn the knob until the clamp is tightened and the pump feels secure. When the knob is as tight as possible, continued turning will make it click and spin freely without over-tightening.

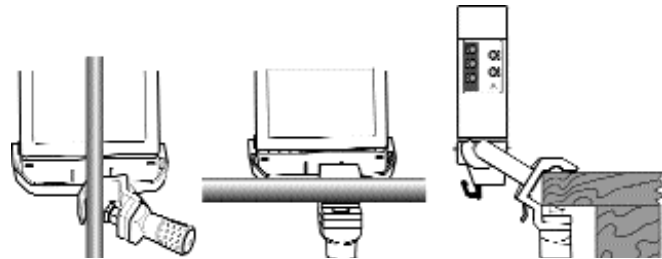

## Operational Precautions

### Patient Precautions

To avoid possible injury to the patient, observe the following precautions:

#### Epidural Administration

The MedSystem III pump can be used for epidural administration of anesthetic and analgesic drugs. This application is only appropriate when using anesthetic and analgesic drugs labeled for continuous epidural administration and catheters intended specifically for epidural use. Use only an IVAC 28 or 25 series set **without** a 'Y' connector or injection port, for epidural infusions. The pump's secondary mode must **not** be used when the pump is being used for epidural administration of anesthetic and analgesic drugs.

- Epidural administration of anesthetic drugs — Use indwelling catheters specifically indicated for short-term (96 hours or less) anesthetic epidural drug delivery.
- Epidural administration of analgesic drugs — Use indwelling catheters specifically indicated for either short-term or long-term analgesic epidural drug delivery.

#### Administration Sets

- Use only IVAC 28 and 25 Series Administration Sets. The use of other sets will cause improper pump operation.
- Do not use the set if damaged.
- Do not insert a cassette into a channel with a Service status.
- Remove any cassettes from channel(s) requiring service.
- Ensure the cassette is properly installed before starting infusions.

#### Electromagnetic and Radio Frequencies

Operating the pump near equipment which radiates high-energy electromagnetic and radio frequencies (electrosurgical/cauterizing equipment, portable radios, cellular telephones, etc.) may cause false alarm conditions. If this happens, reposition the pump away from the source of interference; or turn off the pump and manually regulate the flow with the administration set regulating clamp.

**WARNING:** Epidural administration of drugs other than those indicated for epidural use could result in serious injury to the patient.

**WARNING:** It is strongly recommended that the infusion pump source container and administration set used for epidural drug delivery be clearly differentiated from those used for other types of administration.



---

## Artifacts

It is normal for intravenous infusion devices to produce non-hazardous currents when infusing electrolytes. These currents vary at a rate proportional to the infusion device flow rate. When the ECG monitoring system is not functioning under optimal conditions, these currents may appear as artifacts, simulating actual ECG readings. To determine if ECG abnormalities are caused by patient condition or the ECG equipment, place the infusion device on hold. If the ECG readings become normal, the ECG equipment requires attention. Proper setup of the ECG equipment should eliminate these artifacts. Reference the appropriate ECG monitoring system documentation for instructions on setup and maintenance.

## Dropping/Jarring

If a pump is dropped or severely jarred, it should be immediately taken out of service and inspected by qualified service personnel to ensure proper function prior to reuse.

## User Precautions

To ensure proper performance of the pump and to reduce potential injury to the operator, observe the following precautions:

- The power cord must be connected to a properly grounded, 3-wire receptacle ("Hospital Use" or "Hospital Grade")
- Avoid excessive force or twisting of detachable power cords, when inserting or removing connector terminals.
- Use power cord indoors only.
- Disconnect AC and battery power when performing maintenance.
- Do not use the pump in the presence of flammable anesthetics.
- Do not open the instrument case. The case should only be opened by qualified service personnel using proper grounding techniques.
- Do not stack instruments on top of each other.

**WARNING:** *When the case is opened, an electrical shock hazard exists which can result in serious injury to persons and instrument component damage.*

THERE IS  
NO  
PRINTING  
ON THIS  
PAGE



To Purchase, Visit [Avobus.com](http://Avobus.com) or call [1-800-674-3655](tel:1-800-674-3655)

**Preparing the Infusion**

Prepare solution container in accordance with the manufacturers' instructions.

- A syringe can be used as the container for the IV fluid to be infused. Syringe sizes from 20cc to 60cc of the B-D and Monoject® brands can be used.

**NOTE:** The IVAC Model 8631A Syringe Holder is available as an accessory that provides a convenient place to hold syringes while they are being used as containers for IV fluid. The Syringe Holder is designed to be easily installed and removed from the top of the pump and to support up to three syringes. Do not use the Syringe Holder as a handle to carry the pump.

Connect the container to the IV set.

**Preparing the Administration Set**

Prime the IVAC 28 or 25 Series administration set in accordance with Administration Set Directions for Use.

It is important to prime the set properly to eliminate air bubbles.

Ensure the cassette slide clamp is pushed in completely so tubing is not occluded.

Invert the cassette so tubing is up. Slowly open the regulating clamp and establish fluid flow to fully prime the set. Gently tap the cassette and 'Y' sites as necessary to remove all air. Gently massage the pressure dome to ensure no air bubbles are trapped.

**Loading the Set**

Close regulating clamp before inserting and removing the cassette to reduce the risk of free flow.

Press **ON/OFF RECHARGE** to turn pump on.

With tubing down, use a 45 degree, upward motion to insert cassette into channel.

Push on clear portion of cassette until completely seated. Then push in slide clamp flush with entire cassette.

Pull down gently on tubing collar. Press with thumb to seat tubing collar in recess beneath cassette.

**NOTE:** Three beeps sound when inserted properly.

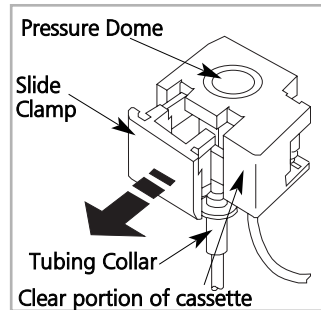

**WARNING:** An open regulating clamp and slide clamp can cause a free-flow condition and may result in serious injury to the patient.

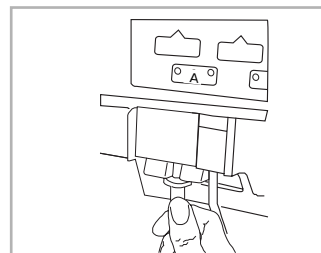
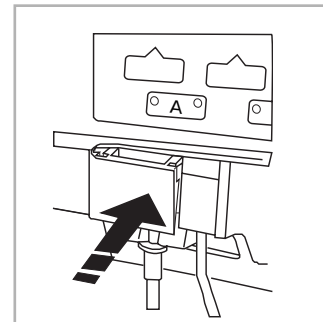

BASIC OPERATION

# Front Panel Overview

## Instrument Control Keys

## Channel Control Key

**ON/OFF Recharge Key**  
Turns the pump on and off.

**STANDARD DISPLAY Key**  
Allows the user to display Standard Display page to view infusion settings for all channels.

**MORE OPTIONS Key**  
Allows the user to display additional softkey functions.

**START/STOP Key**  
Starts or stops infusion on selected channel.

## Standard Display Page

**Status Line**  
Displays infusion status (*Infusing; Stopped; Standby; KVO; ALARM; FAULT; SERVICE*) for each channel.

**NOTE:** Status line in selected channel is highlighted.

**Infusion Rate**

**Volume Remaining**

**Volume Infused**

**Prompt Line**  
Displays messages that prompt the user to make programming choices and/or take appropriate actions.

**Softkeys Prompts**  
Displays function of specific softkey.

**STNDBY** – Appears in softkey information line when  is pressed during infusion.

**Cntrst** – (Contrast) Brightens or dims display.

**GP II** – When pressed, indicates full name of selected Device Type on the prompt line.

**NOTE:** Additional softkey prompts are displayed by pressing More Options.

**Softkey Pads (4)**

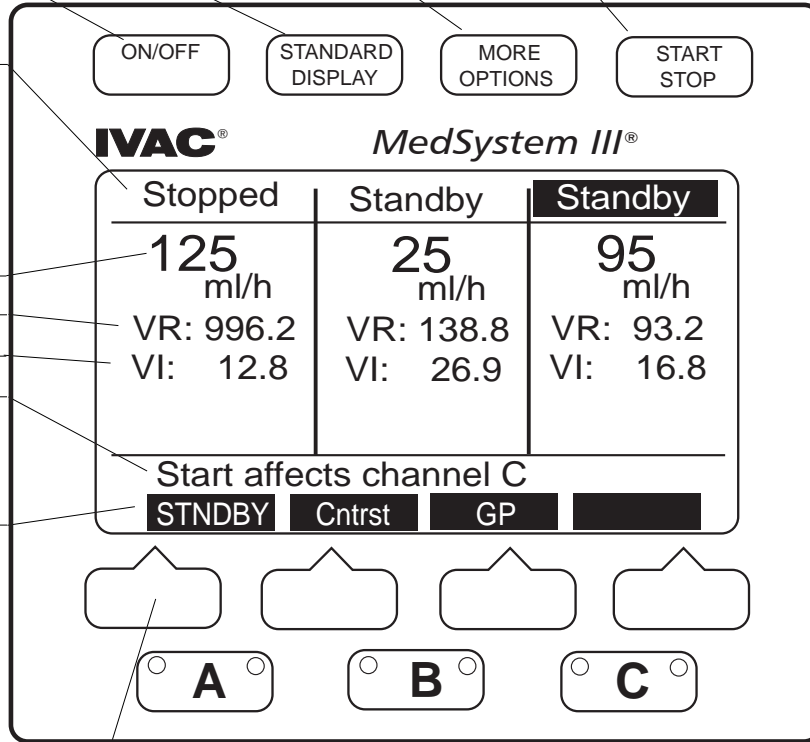

**Programming Page**

Selected channel is indicated by the letter displayed at the beginning of the first five lines.

Status Line  
Displays infusion status for selected channel.

Infusion Rate

Volume Remaining

Time Remaining

Volume Infused

Date/Time  
Displays when volume infused was last cleared and infusion began.

Prompt Line  
Displays messages that prompt the user to make programming choices and/or take appropriate action.

Soft Key Prompts  
Displays function of specific softkey.

Select – Moves highlight bar through the programmable infusion parameters.

↑ – Increases highlighted value.

↓ – Decreases highlighted value.

Fast ↑ – Increases highlighted value at greater increments.

Fast ↓ – Decreases highlighted value at greater increments.

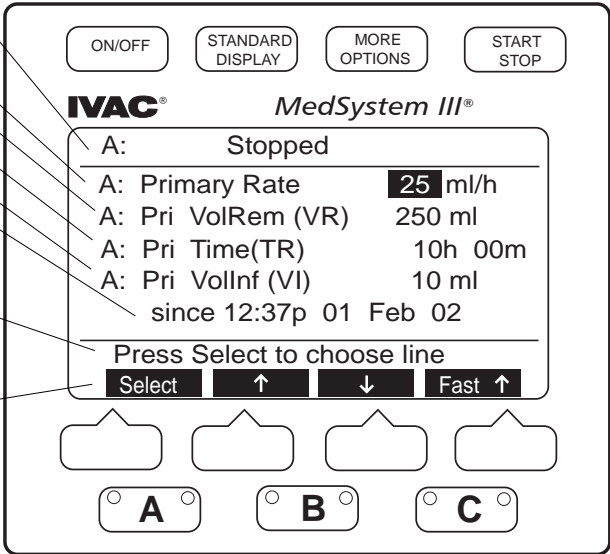

### To turn pump on

Press .

- Instrument information page is momentarily displayed.
- Continuing to hold down ON/OFF key will keep the information on the display.
- When the ON/OFF key is released, the Standard Display page is displayed.

### To turn pump off

Press and hold .

- Display disappears.
- Pump is turned off.

### To view infusion settings for all active channels

Press .

- Standard Display page is displayed.

### To activate additional Standard Display softkey prompts

With the Standard Display page displayed:

Press , once.

- TotVol, Device, Config, and Note softkeys appear.

Press  again.

- Batlog and DemoWd softkeys appear.

### To select channel and display Programming Pages

Press , , or .

- Selected channel programming page is displayed.



### To program infusion

With programming page displayed:

Press  to choose value to change.

- Value is highlighted.

Scroll through values using , , , or .

-  and  increases highlighted values in single or multiple increments.

- $\downarrow$  and **FAST**  $\downarrow$  decreases highlighted values in single or multiple increments.
- Pressing  $\uparrow$  or  $\downarrow$  changes direction of the **FAST**  $\uparrow$  or **FAST**  $\downarrow$
- Highlight remains flashing until **Enter** is pressed. If **Enter** is not pressed, the entry incomplete advisory will sound.

Press **Enter** to accept new value.

- Highlight moves to next programmable value if channel status is **Stopped** OR **Standby**.
- If status is **Infusing**, highlight remains on selected value.

To recall a previous value after a new value is introduced but not entered, press **MORE OPTIONS**.

- Recall soft key appears.

Press **Recall**.

- Number returns to previous value.

Press **START STOP**.

- Infusion starts or stops immediately, unless the channel's programming is incomplete, or if an advisory, alarm, or fault condition exists on selected channel.

See the **TROUBLESHOOTING** section of this manual for more alarm information.

#### To access alarm information

- **ALARM** is displayed in affected channel status line.
- Alarm condition is displayed on the Standard Display of the affected channel.

Press affected channel **A**, **B**, or **C**.

- Alarm Information page is displayed for that channel.

#### To activate additional Programming Page softkeys

With the programming page displayed:

Press **MORE OPTIONS**.

Press **2<sup>sec</sup>** to access Secondary page.

Press **CalcOn** to access Dose Rate Calculation page.

Press **MORE OPTIONS**.

Press **CalcOff** to discontinue use of the Dose Rate Calculator.

See the **ADVANCED OPERATION** section of this manual for information on the use of the Dose Rate Calculator function.

## Programming Primary Infusion

### To set primary rate

Press **A**, **B**, or **C**.

- Programming Page is displayed.
- Rate is highlighted.

Press **Select** if current rate is desired

Press **↑**, **↓**, **FAST ↑**, or **FAST ↓** to change Rate.

- Value flashes.

Press **Enter** to confirm.

- Highlight moves to volume remaining (VR)

### To set primary volume remaining (VR)

Press **Select** if current VR is desired

Press **↑**, **↓**, **FAST ↑**, or **FAST ↓** to change VR.

- Value flashes.

Press **Enter** to confirm.

- Primary time remaining (TR) is calculated automatically, based on VR and Rate.
- Highlight moves to volume infused (VI).

### To clear primary volume infused (VI)

Press **Select** if current VI is desired

Press **Clear** to reset volume infused to zero.

- Date and time are cleared.
- **Clear** softkey switches to **Recall**.

Pressing **Recall** softkey recalls previous VI value.

Press **Enter** to confirm.

**THEN**

Open regulating clamp on administration set.

Press **START STOP** to begin infusion.

- Channel starts infusing.
- Current date and time are entered.
- Green infusion light on channel key stays lit.
- Display reverts to Standard Display page after one minute.

Verify solution flow.

Press **STANDARD DISPLAY**.

Verify settings.

A: Stopped	
A: Primary Rate	100 ml/h
A: Pri VolRem (VR)	500 ml
A: Pri Time(TR)	05h 00m
A: Pri VolInf(VI)	1 ml
since 12:37p 01 Feb 02	
Press Select to choose line	
Select	Fast ↑

A: Stopped	
A: Primary Rate	100 ml/h
A: Pri VolRem (VR)	500 ml
A: Pri Time(TR)	05h 00m
A: Pri VolInf(VI)	1 ml
since 12:37p 01 Feb 02	
Press Select to choose line	
Select	Fast ↑

A: Stopped	
A: Primary Rate	100 ml/h
A: Pri VolRem (VR)	500 ml
A: Pri Time(TR)	05h 00m
A: Pri VolInf(VI)	800 ml
since 12:37p 01 Feb 02	
Press Select to choose line	
Select	Clear

A: Stopped	
A: Primary Rate	100 ml/h
A: Pri VolRem (VR)	500 ml
A: Pri Time(TR)	05h 00m
A: Pri VolInf(VI)	0 ml
since -----	
Press Enter or Recall	
Enter	Recall





## Making Changes While Infusing

### To titrate or change primary rate during infusion

Press **A**, **B**, or **C**.

- Programming Page is displayed.
- Rate is highlighted.

Press  $\uparrow$ ,  $\downarrow$ , FAST  $\uparrow$ , or FAST  $\downarrow$  to change Rate

- Value flashes.

Press Enter to confirm.

- New rate begins infusing immediately.

### To change volume remaining during infusion

Press **A**, **B**, or **C**.

- Programming Page is displayed.
- Rate is highlighted.

Press Select to highlight VR.

Press  $\uparrow$ ,  $\downarrow$ , FAST  $\uparrow$ , or FAST  $\downarrow$  to change VR.

- Value flashes.

Press Enter to confirm.

- Infusion continues with new volume remaining.

### To clear volume infused during infusion

Press **A**, **B**, or **C**.

- Programming Page is displayed.
- Rate is highlighted.

Press Select to highlight VI.

Press Clear then Enter to reset volume infused to zero.

- Date and time are cleared.
- Clear softkey switches to Recall.

Pressing Recall softkey recalls previous VI value.

OR

Press Enter to confirm.

- Infusion continues with volume infused reset to zero.
- Current date and time are entered.

*NOTE: When the channel VI is cleared, that volume is not subtracted from the volume on the TotVol page.*

**To simultaneously clear Total Volume Infused for all channels**

Press **STANDARD DISPLAY**.

- Standard Display page is displayed.

Press **MORE OPTIONS**.

- TotVol, Device, Config and Note softkeys appear.

Press TotVol softkey.

- Total Volume page is displayed
- VI for each channel and total pump VI values are highlighted.

Press ClrTot to reset volume infused to zero.

- Date and time are cleared.

Press Enter to accept clearing of all values.

OR

Press RECALL to return the previous Total VI.

Stopped	Stopped	Stopped
TotVI A	TotVI B	TotVI C
Pri 20	Pri 20	Pri 20
Sec 0	Sec 0	Sec 0
= 20	= 20	= 20
Total VI = 60 ml		
since 03:25p 10 Feb 02		
Press ClrTot to clear TotVI		
		ClrTot

Stopped	Stopped	Stopped
TotVI A	TotVI B	TotVI C
Pri 0	Pri 0	Pri 0
Sec 0	Sec 0	Sec 0
= 0	= 0	= 0
Total VI = 0 ml		
since ----		
Press Enter or Recall		
Enter		Recall

**To place a channel on Standby during infusion**

Press appropriate channel **A**, **B**, or **C**.

Press **START STOP** to stop infusion.

Press **STANDARD DISPLAY**.

- Standard Display page is displayed.

Press Stndby.

Stopped		
100		
ml/h		
VR: 450		
VI: 50		
Start affects channel A		
STNDBY	Cntrst	GP II

**To start an infusion from Standby status**

Press appropriate channel **A**, **B**, or **C**.

Press **START STOP** to start infusion.

**Programming Option**

**To set up an infusion by Rate/Volume or Volume/Time**

Press **STANDARD DISPLAY** if Standard Display page not already displayed.

Press **MORE OPTIONS**.

- TotVol, Device, Config and Note softkeys appear.

Press Config softkey.

- The first of five Instrument Settings pages is displayed.

Press Select to move the highlight to Setup Line Option.

Press ↑ or ↓ to choose Yes.

- ↑ and ↓ will not be displayed if pump is infusing.

Press Enter to enable programming option.

Press channel **A**, **B**, or **C**.

*NOTE: When a channel is Stopped for two minutes with a cassette in place, a Channel Not In Use advisory sounds. When a channel is on Standby, the advisory does not sound.*

*NOTE: Infusing channel should always be stopped prior to removing cassette.*

Instrument Settings (1 of 5)	
* Audio Volume:	highest
Sec Complete Advisory:	No
Setup Line Option	No
Time: am/pm 02:16p 01 Jul 02	
Press Stnd Display to Exit	
Select	NextPg

Press **START STOP** if channel is infusing.

Press **Select** to move highlight to

Setup: Select VR and Time.

**OR**

Setup: Select VR and Rate

If highlighted choice is not desired, use arrow softkeys to change setup choice.

- Choice flashes.

Press **Enter** to accept .

- Highlight moves to top of page.

A:	Stopped
A: Primary Rate	100 ml/h
A: Pri VolRem (VR)	500 ml
A: Pri Time(TR)	05h 00m
A: Pri VolInf(VI)	1 ml
	since 02:16p 01 Jul 02
Setup:	<b>Select VR and Time</b>
Press Select to choose line	
<b>Select</b>	<b>↑</b> <b>↓</b>

A:	Stopped
A: Primary Rate	100 ml/h
A: Pri VolRem (VR)	500 ml
A: Pri Time(TR)	05h 00m
A: Pri VolInf(VI)	1 ml
	since 02:16p 01 Jul 02
Setup:	<b>Select VR and Rate</b>
Press Enter or Recall	
<b>Enter</b>	<b>↑</b> <b>↓</b> <b>Recall</b>

*NOTE: Rate will highlight but cannot be changed if Volume/Time option is active. Time remaining selection will highlight but cannot be changed if Rate/Volume option active.*

BASIC OPERATION

## KVO Status

### To resume infusion when VR=0 (KVO)

With a channel infusing at KVO rate:

- Green light on channel key remains on.
- Red light on channel key flashes .
- Two toned advisory sounds.

Press appropriate channel **A** , **B** , or **C** twice.

- VR is highlighted.

Press **REPEAT** to recall previous VR.

**OR**

Press **↑** , **↓** , **FAST ↑** , and **FAST ↓** to change VR.

- Value flashes.

Press **Enter** to confirm.

Press **START STOP** to resume infusion and stop KVO rate.

*NOTE: If current infusion rate is set below KVO rate, channel will infuse at the lower rate.*

<b>KVO</b>		
<b>100</b>		
Infusion Complete		
VR = 0		
Alarm Info: Press A		
<b>↑</b>	<b>Cntrst</b>	<b>GP II</b>

A:	KVO	3.0 ml/h
A: Primary Rate	100 ml/h	
A: Pri VolRem (VR)	<b>0</b> ml	
A: Pri Time (TR)	----	
A: Pri VolInf (VI)	100 ml	
	since 12:37p 01 Feb 02	
Press Select to choose line		
<b>Select</b>	<b>↑</b> <b>↓</b>	<b>REPEAT</b>

THERE IS  
NO  
PRINTING  
ON THIS  
PAGE

## Secondary Mode

This option allows two different rates of infusion to be administered sequentially. When secondary volume remaining reaches zero, primary infusion resumes automatically.

To avoid the possibility of sympathetic flow during secondary delivery of intermittent medications, set up the administration set as recommended below.

## Preparing the Administration Set and Container

- Use a 16 gauge needle to attach secondary set to primary upper 'Y' site, below a check valve.
- Prepare the secondary IV container according to your institution's policy.
- Suspend secondary solution container at least 8 inches above primary solution container.
- Press **A**, **B**, or **C** to select channel.

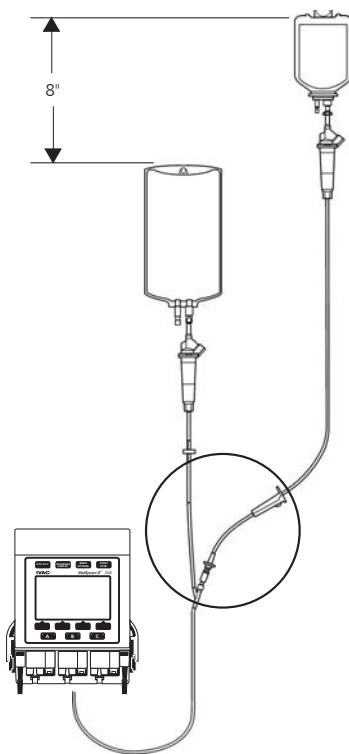

**WARNING:** *Setting a secondary rate over 275 ml/h may result in sympathetic flow with the primary container.*

ADVANCED OPERATION

**Programming Secondary Infusion**

Press **A**, **B**, or **C**.

- Primary programming page is displayed.

Press **MORE OPTIONS**.

Press **2° Sec** softkey.

- Secondary programming page is displayed.

**To set secondary volume remaining (VR)**

Press **Select** to highlight secondary VR, if necessary.

Press **REPEAT** to enter the last VR selected.

OR

Press **↑**, **↓**, **Fast ↑** or **Fast ↓** to change VR.

- Value flashes.

Press **Enter** to confirm.

- Secondary time remaining (TR) is calculated automatically, based on VR and Rate.
- Highlight moves to secondary volume infused (VI).

**To clear secondary volume infused (VI)**

Press **Select** if current VI is desired

OR

Press **Clear** to reset volume infused to zero.

- Date and time are cleared.
- **Clear** softkey switches to **Recall**.

Pressing **Recall** softkey recalls previous VI value.

Press **Enter** to confirm.

**To set secondary rate**

Press **Select** if current rate is desired

OR

Press **↑**, **↓**, **Fast ↑** or **Fast ↓** to change Rate.

- Value flashes.

Press **Enter** to confirm.

**THEN**

Open regulating clamp on secondary administration set.

Press **START STOP** to begin infusion.

- Four tones sound if primary infusion is in progress.
- Pump starts infusing at secondary rate.
- Current date and time are entered.

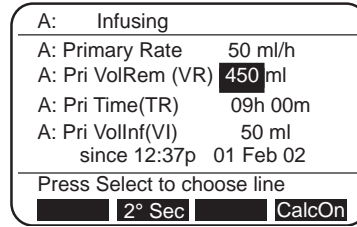

*NOTE: Secondary programming page is reverse highlighted.*

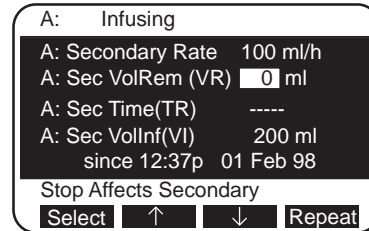

- Display reverts to Standard Display page after one minute.

Press **STANDARD DISPLAY**.  
Verify settings.

Verify solution flow from secondary container.

To titrate or change secondary rate during infusion

Press **A**, **B**, or **C**.

- Secondary programming page is displayed.
- Rate is highlighted.

Press **↑**, **↓**, **Fast ↑** or **Fast ↓** to change rate.

- Value flashes.

Press **Enter** to confirm.

- New rate begins infusing immediately.

To review or change primary value(s) during secondary infusion

Press **A**, **B**, or **C**.

- Secondary programming page is displayed.

Press **MORE OPTIONS**.

- **1° Pri** and **CalcOn** softkeys appear.

Press **1° Pri** softkey.

- Primary programming page is displayed.

Press **Select** to highlight value(s) to change.

Press **↑**, **↓**, **Fast ↑** or **Fast ↓** to change value(s).

Press **Enter** to confirm.

To start primary infusion before secondary completes

Close regulating clamp on secondary infusion set.

Press **A**, **B**, or **C**.

- Secondary programming page is displayed.

Press **MORE OPTIONS**.

- **1° Pri** and **CalcOn** softkeys appear.

Press **1° Pri** softkey.

- Primary programming page is displayed.

Press **START STOP** to begin primary infusion and stop secondary infusion.

- Four tones will sound.
- Infusion starts at primary rate.

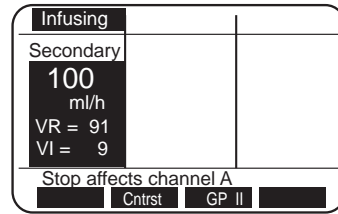

**NOTE:** Channel display on the Standard Display is reverse highlighted.

**WARNING:** Pressing **START STOP** would result in the remaining secondary medication being delivered at the primary rate.

## Dose Rate Calculator (DRC) Programming using a specific drug name

With this feature, the instrument calculates a volumetric or dose rate based on values entered for patient weight, drug concentration (*drug amount and diluent volume*) and dosing parameters. If a dose is entered, the volumetric rate is calculated. If a volumetric rate is entered, the dose is calculated.

Press **A**, **B**, or **C**.

- Primary programming page is displayed.

If infusing, press **START STOP** to stop infusion.

Press **MORE OPTIONS**.

- **2° Sec** and **CalcOn** softkeys appear.

Press **CalcOn**.

- Dose Rate Calculator programming page is displayed.
- **Drug?** is highlighted.

### Programming Drug

Scroll using arrow softkeys to display alphabetized, abbreviated, generic drug names.

- ↓ moves A to Z.
- ↑ moves Z to A.

e.g. **Dopamine**     **mg/ml** and     **mcg/kg/min**  
**Lidocaine**     **Gm/ml** and     **mg/min**

Press **Enter** when desired drug name is highlighted.

- Highlight moves to **Wt**.

### Programming Weight

Choose patient's kilogram weight using the arrow softkeys.

Press **Enter** when desired weight is displayed.

- Highlight moves to **Conc**.

### Programming Concentration

Choose concentration using the arrow softkeys.

Press **Enter** when desired concentration is displayed.

- Highlight moves to value for diluent volume.

Choose diluent volume using the arrow softkeys.

Press **Enter** when desired volume is displayed.

- VR is automatically set when the diluent volume value is entered but can be changed if desired.
- Highlight moves to **Dose**.

**WARNING:** *Ensure correct entry of all drug calculation infusion parameters. Consult the drug manufacturer's labeling for information concerning appropriate administration guidelines and dosages.*

**NOTE:** *Dose Rate programming page will not display if channel is infusing. If infusing in secondary mode, switch to primary mode and stop infusion before proceeding.*

A:	Stopped		
<b>DRUG?</b>	Wt	----	KG= 0.0 LB
A:Conc	-----	mg/----	ml
A:Dose	-----	mcg/kg/min	
A:Rate	-----	ml/h	
A:VR	1	ml (Vol Rem)	
A:VI	0 ml	DI	0.0 mg
Press Select to choose line			
Select	↑	↓	Clear

**NOTE:** *Pressing **A**, **B**, or **C** at any time during DRC set-up, returns the highlight to the top of the page.*

**NOTE:** *Changing drug name clears previous values and changes drug concentration and dose rate parameters to parameters appropriate for the selected drug.*

A:	Stopped		
<b>DOPAMINE</b>	Wt	70.0	KG=154.3LB
A:Conc	400	mg/	250 ml
A:Dose	5.0	mcg/kg/min	
A:Rate	13.1	ml/h	
A:VR	250	ml (Vol Rem)	
A:VI	0 ml	DI	0.0 mg
Press Select to choose line			
Select	↑	↓	Fast ↑



### Programming Dose

Choose dose using the arrow softkeys.

Press **Enter** when desired dose is displayed.

- Volumetric rate is automatically calculated.
- Highlight moves to **Rate**.

### Changing Volumetric Rate

Choose rate value using the arrow softkeys if dose rate is not desired.

Press **Enter** when desired volumetric rate is displayed.

- When rate is changed, dose value is automatically calculated.
- Highlight moves to VR.

### Changing Volume Remaining

Change VR value using the arrow softkeys.

Press **Enter** when desired VR is displayed.

- Highlight moves to VI.

### Clearing the Volume Infused(VI) and Dose Infused(DI)

Press **Clear** then **Enter** to reset volume infused to zero.

- Highlight moves to DI.

Press **Clear** then **Enter** to reset dose infused to zero.

Open regulating clamp.

Press **START STOP** to begin infusing.

- Channel starts infusion.
- Display switches to Standard Display page after 1 minute. DRC parameters are displayed.

Verify fluid flow.

Press **STANDARD DISPLAY**.

Verify settings.

### Changing DRC values while infusing

Press **A**, **B**, or **C**.

- Dose Rate Calculator programming page is displayed.
- Dose value is highlighted.

Press **Select** to scroll through values that can be changed.

When highlight is on value to be changed (*Dose, Rate, VR, VI, DI*), use arrow softkeys until desired value is displayed.

- When dose is changed, rate is automatically recalculated.
- When rate is changed, dose is automatically recalculated.

When highlight is on value for VI or DI, **Clear** softkey becomes active.

Pressing the **Clear** softkey changes the value to 0.0.

Press **Enter** after each value change to accept the new value.

- New rate begins infusing immediately.

Press **STANDARD DISPLAY**.

- Verify settings.

**NOTE:** Calculated rates for infusion are fractional and will be displayed as a fraction on the Standard Display even if Device Type is set for whole numbers.

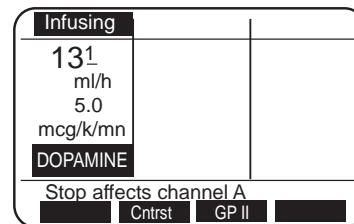

ADVANCED OPERATION

**NOTE:** Stop infusion to make changes to the drug name, weight, or concentration.

**Dose Rate Calculator Programming with DRUG?**

**NOTE:** Dose Rate programming page will not display if channel is infusing. If infusing in secondary mode, switch to primary mode and stop infusion before proceeding.

The **Drug?** selection can be used to calculate a drug not listed in the pump or for an alternative dosing regimen.

Press **A**, **B**, or **C**.

- Primary programming page is displayed.

Press **START STOP** if channel is infusing.

Press **MORE OPTIONS**.

- **2<sup>o</sup> Sec** and **CalcOn** softkeys appear.

Press **CalcOn**.

- Dose Rate Calculator programming page is displayed.
- **Drug?** is highlighted.

Press **Select**.

- Highlight moves to **Wt**.

**Programming Weight**

Choose patient's KG weight using arrow softkeys.

Press **Enter** when desired weight is displayed.

- Highlight moves to **Conc**.

**Programming Concentration**

Choose concentration using arrow softkeys.

Press **Enter** when desired concentration is displayed.

- Highlight moves to concentration parameters.

Choose desired concentration parameters using arrow softkeys.

Press **Enter** when desired parameter is displayed.

- Highlight moves to value for diluent volume.

Choose diluent volume value using arrow softkeys.

Press **Enter** when desired volume is displayed.

- VR is automatically set when the diluent volume is entered, but can be changed if desired.
- Highlight moves to **Dose** parameters.

**Programming Dose**

Choose dose parameters (*measure/weight/time*) using arrow softkeys.

Press **Enter** when each desired dose parameter is displayed.

- Highlight moves to next parameter each time **Enter** is pressed.
- Highlight moves to **Dose** when **Enter** is pressed to accept time value.

Choose dose using arrow softkeys.

Press **Enter**.

- Highlight moves to **Rate** parameters.

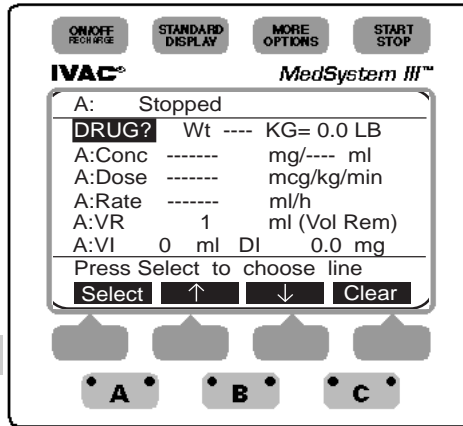

Drug concentration parameters  
Gm, mg, mcg, mMol, mEq, mUn, and Un

Dose parameters  
measure — Gm, mg, mcg, Ng, mMol, mEq, mUn, or Un  
weight — kg  
time — min, hr, or day

### Changing Volumetric Rate

Choose volumetric rate using arrow softkeys if dose calculation is not desired. Press **Enter** when desired rate is displayed.

- When rate is changed, dose is automatically calculated.
- Highlight moves to VR.

### Changing Volume Remaining

Choose VR value using the arrow softkeys. Press **Enter** when desired VR is displayed.

- Highlight moves to VI.

### Clearing Volume Infused (VI) or Dose Infused (DI)

Press **Clear** then **Enter** to change VI value to 0.

- Highlight moves to DI.

Press **Clear** then **Enter** to change DI value to 0.

Open regulating clamp.

Press  to begin infusion.

- Channel starts infusing.
- Display switches to Standard Display page after 1 minute. DRC parameters are displayed.

Verify fluid flow.

Press .

Verify settings.

### Discontinuing DRC option

Press , , or .



- Dose Rate Calculator programming page is displayed.

Press  to stop if infusing.

Press .

Press **CalcOff**.

- Display reverts to primary programming page.
- Volumetric rate, volume remaining and volume infused from DRC is carried over to the primary programming page.

A: Stopped		
<b>DOPAMINE</b>	Wt 70.0	KG=154.3LB
A:Conc	400	mg/ 250 ml
A:Dose	5.0	mcg/kg/min
A:Rate	13.1	ml/h
A:VR	250	ml (Vol Rem)
A:VI	0 ml	DI 0.0 mg
Press Select to choose line		
		<b>CalcOff</b>

### Facts about DRC

- Drug name, patient weight, or drug concentration cannot be changed while infusing. Changes to patient weight or concentration will recalculate volumetric rate but maintain dose rate.
- All drug names are generic and abbreviated if the name contains more than eight letters.
- Weight can only be entered in Kg's but is displayed in Kg's **and** Lbs. Weight units can be switched to grams by pressing ↓ to value of 1Kg then repress ↓. A two tone advisory sounds.
- If dose measurement parameters and concentration measurement parameters are unrelated, a volumetric rate will not calculate. Attempts to start will display a prompt message: **Verify all dose settings**.
- When a drug amount is 10,000 or greater, a **K** is used to replace 000th (i.e. 10,000 = 10K; 12,000 = 12K).
- If a recalculated dose results in a rate outside the rate ranges, a prompt message is displayed: **Rate too High, reenter value or Rate too Low, reenter value**.
- If a recalculated rate results in a dose outside the dose range, the channel will infuse at the entered rate but the dose will display the minimum or maximum allowable limit: (i.e. <0.1 or >999k).
- Secondary option cannot be used when the Dose Rate Calculator is enabled.
- If instrument is off for more than five minutes, the DRC mode will revert to the primary mode.

## Device

There are six Device Types with preset parameters that accommodate specific clinical applications. They are:

- |                            |                           |
|----------------------------|---------------------------|
| <b>General Purpose</b>     | <b>Operating Room</b>     |
| <b>Neonatal</b>            | <b>General Purpose II</b> |
| <b>Controller Pressure</b> | <b>Operating Room II</b>  |

When setting up the pump, select the device type that best suits your clinical needs. The abbreviated name of the Device Type appears as a softkey on the Standard Display page. Pressing the softkey displays the device type on the prompt line.

Maximum rate, maximum volume, pressure and air-in-line threshold are configured at the factory. See *Table 1* for a complete listing of preset parameters. Refer to the config softkey section following Table 1 for programmable and configurable parameters. These parameters can be modified to meet the institution's specific requirements using the optional FMS software.

*NOTE: The Device Type programming selection affects all three channels. It is not possible to program different Device Types for a channel independently.*

## To change Device Type

Press **STANDARD DISPLAY**.

Press **MORE OPTIONS**.

- **TotVol**, **Device**, **Config** and **Note** softkeys appear.

Press **Device** softkey.

- The currently selected Device Type has an asterisk and is highlighted.

Press **Select** to move the highlight through the list.

Press **Enter** when the desired device is highlighted.

If preset values are compatible with the newly selected device type,

- An asterisk appears next to the device name.

If channel is **not** infusing when device type is changed and preset values are **not** compatible with the newly selected device type,

- The display switches to a notification screen.
- Incompatible Channel(s) indicated.
- Choice is given to continue.

If **Yes**,

- Incompatible values are cleared.
- Display reverts to Standard Display Page.
- New Device Type becomes active.

If **No**,

- Display reverts to Change Device Type page.

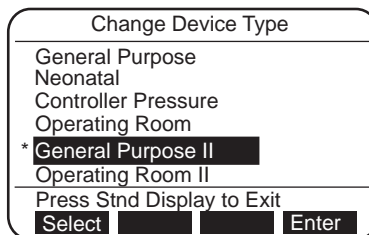
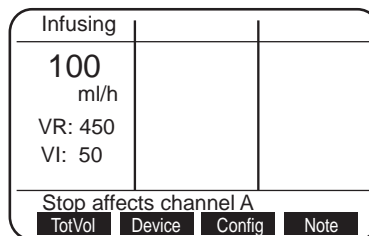
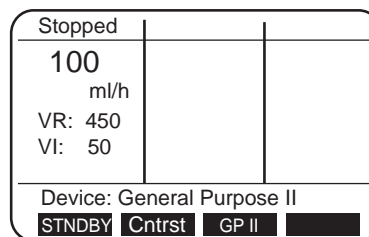

If channel **is** infusing when device type is changed and preset values are **not** compatible with the newly selected device type,

- The display switches to the notification screen.
- Incompatible Channel(s) is indicated.
- Choice is given to continue.

If **No**,

- Display reverts to Change Device Type page for user to select another device type.

If **Yes**,

- The pump will alarm.
- Infusion will stop on affected channel.
- Display reverts to Standard Display with Alarm indicated in affected channel.

Press affected channel **A**, **B**, or **C**.

Follow instructions displayed.

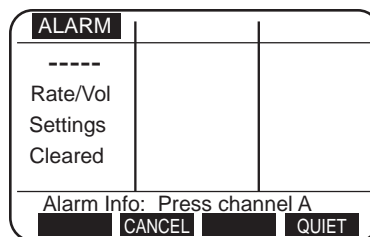

**Table 1**

Default Parameter	General Purpose	Neonatal	Controller Pressure	Operating Room	General Purpose II	Operating Room II
Occlusion Detection Method	Baseline	Baseline	Absolute Threshold	Baseline	Baseline	Baseline
Occlusion Alarm Setting	Baseline +5 psi	Baseline +3 psi	Absolute 3 ft H <sub>2</sub> O	Baseline +5 psi	Baseline +5 psi	Baseline +5 psi
Maximum Pressure	15 psi	15 psi	3 ft H <sub>2</sub> O	15 psi	15 psi	15 psi
Air-in-line Alarm Threshold	500 µl	50 µl	500 µl	500 µl	500 µl	500 µl
KVO Rate*	3 ml/h	1.0 ml/h	3 ml/h	3 ml/h	3.0 ml/h	3.0 ml/h
Rate Range	1—999 ml/h	0.1—99.9 ml/h	1—299 ml/h	1—999 ml/h	0.1—999 ml/h	0.1—999 ml/h
Maximum VR Setting	9999 ml	9999 ml	9999 ml	9999 ml	9999 ml	9999 ml
Pump Not In Use Advisory	Yes	Yes	Yes	No	Yes	No
ALL Setting for VR	N/A	N/A	N/A	Option	N/A	Option

*NOTE: Values shown in table can be modified to meet the institution's requirements using optional FMS software. To review actual default parameters on a MedSystem III pump, select a Device Type and refer to Instrument Settings pages 2 through 5. An asterisk appears beside settings which are not factory default.*

\* Channel will infuse at the KVO rate shown in table or at the current infusion rate, whichever is lower.

## Config (Configuration)

The Config option allows the user to view and/or change some instrument settings. There are five pages in this option. Items shown on page 1 can be changed by user (see *Table 2*). Pages 2 - 5 can only be changed by qualified personnel using the optional FMS software .

### To access Instrument Settings information

Press  .

Press  .

- **TotVol**, **Device**, **Config** and **Note** softkeys appear.

Press **Config** softkey.

- The first of five Instrument Settings pages is displayed.
- An asterisk indicates options that have been changed from factory settings.

Pressing **Select** moves the highlight through the list .

Press **↑** and **↓** to change a highlighted setting.





- **Select** softkey changes to **Enter** and **NextPg** softkey changes to **Recall** when a setting is changed.





Press **Enter** to accept new setting

OR

Press **Recall** to recall previous setting.

Press  to exit Instrument Settings page.

Infusing		
100		
ml/h		
VR: 450		
VI: 50		
Stop affects channel A		
		
		

Instrument Settings ( 1 of 5 )	
*Audio Volume:	
*Sec Complete Advisory:	Yes
Setup Line Option:	No
Time: am/pm 9:56a 01 Feb 02	
Press Stnd Display to Exit	
	
	

**Table 2**

Option	Choices	Description
Audio Volume:	low medium high highest	A tone accompanies each level to aid in determining volume choice. If an alarm is ignored, the volume will ramp to the highest audio unless disabled by FMS.
Sec Complete Advisory:	Yes No	Pump sounds two tones and displays advisory when secondary VR = 0.
Setup Line Option:	No Yes	Enables infusion to be set up as rate/volume or volume/time. Stop infusion before modifying this line option.
Time:	24 hr am/pm	Allows pump to be set with a 12 or 24 hour clock.
Hour/minutes	0000-2359	} Each item can be adjusted when highlighted
Day	1-31	
Month	Jan-Dec	
Years	00-99	

## Note

The Note soft key accesses the Special Note Message page. When note is programmed, it appears when the pump is turned on.

To access Note(s)

Press .

Press .

- **TotVol**, **Device**, **Config** and **Note** softkeys appear.

Press **Note** softkey.

- Note information is displayed.
- If no information has been programmed on the note page, there will be a two tone advisory and the message **There is no Special Note** will display on the prompt line.

Infusing		
100 ml/h		
VR: 450		
VI: 50		
Stop affects channel A		
TotVol	Device	Config Note

Infusing		
100 ml/h		
VR: 450		
VI: 50		
There is no Special Note		
TotVol	Device	Config Note

## BatLog (Battery History Log)

The BatLog softkey accesses the Battery History Log page. This page is provided for the Biomedical Engineering staff to review and record battery history data.

To access Battery History Log

Press .

Press  twice.

- **BatLog** and **DemoWD** softkeys appear.

Press **BatLog** softkey.

- The Battery History page is displayed.

Display switches to Standard Display page after 1 minute

OR

Press  to exit Battery History page.

Infusing		
100 ml/h		
VR: 450		
VI: 50		
Stop affects channel A		
	BatLog	DemoWD

ADVANCED OPERATION

THERE IS  
NO  
PRINTING  
ON THIS  
PAGE



## TROUBLESHOOTING

Use this troubleshooting information in conjunction with appropriate hospital procedures.

### To respond to an advisory, alarm, or fault message

Press **QUIET**.

- Audio tone stops.
- Red light flashes on affected channel.

Press affected channel **A**, **B**, or **C**

- Alarm Information page is displayed.

Take appropriate action(s) indicated on the display.

Press **START STOP** to resume infusion.

### Alarm Response Keys

**QUIET** silences Advisories, Alarms, and Faults for two minutes. Softkey is accessible during alarm status.

**CANCEL** clears alarm and advisory messages and stops tone. Use when alarm or advisory condition cannot be corrected or user chooses not to correct.

**ClrAir** moves air bubbles past air-in-line sensor. Each press of the ClrAir softkey displaces 0.2 ml of air and fluid. Three beeps indicate when air bubble is no longer in front of the air-in-line sensor.

**CONFIRM** is present during **Check Fluid Side** alarms. Allows infusion to continue if no upstream occlusion is found and fluid is flowing in drip chamber.

**RETRY** resets resumable fault conditions. Used when attempting to re-establish normal operation of a channel.

**SERVICE** disables use of affected channel. Servicing of the pump is required before channel can be used.



*NOTE: Channel's VR and VI calculations are updated with each press of ClrAir softkey.*

*NOTE: A ✓ appears on Standard Display page to indicate CONFIRM has been pressed.*

## Advisories

Two beeps, slow flashing red light on infusing channel's channel key; infusion continues.



### CORRECTIVE ACTION

<p><b>Check Air Sensor</b></p> <p>At installation of cassette:</p> <p>a) air is detected in tubing; b) tubing collar is not properly seated;</p> <p style="text-align: center;"><b>OR</b></p> <p>c) air sensor is dirty or damaged.</p>	<ul style="list-style-type: none"> <li>• Verify tubing collar is fully seated in air sensor recess.</li> <li>• Verify tubing in air sensor recess is not damaged, twisted or dirty.</li> <li>• Press <b>ClrAir</b> on channel's Alarm Information page. Three beeps indicate air bubble is no longer in front of air sensor.</li> <li>• If air is still present, remove cassette and manually clear air according to hospital policy.</li> <li>• If no air is present, clean air sensor recess as directed in cleaning instructions.</li> </ul>
<p><b>Infusion Complete VR=0</b></p> <p>VR has counted down to zero. Channel is infusing at KVO rate.</p>	<ul style="list-style-type: none"> <li>• Enter new VR or, if same volume is desired, press <b>REPEAT</b>.</li> <li>• Press <b>Enter</b>.</li> <li>• Press  to resume primary infusion rate.</li> </ul>
<p><b>Low Battery</b></p> <p>30 minutes or less battery power remaining.</p>	<ul style="list-style-type: none"> <li>• Connect AC adapter power cord to pump.</li> <li>• Plug into wall outlet.</li> </ul>
<p><b>Channel Not In Use</b></p> <p>Two minutes have elapsed since cassette was installed or infusion was stopped.</p>	<ul style="list-style-type: none"> <li>• Remove cassette,</li> <li style="text-align: center;"><b>OR</b></li> <li>• Press  to start infusion,</li> <li style="text-align: center;"><b>OR</b></li> <li>• Press <b>STNDBY</b> to place channel on Standby.</li> </ul>

## Alarms

Four rapid-beeps, infusion stops, rapidly flashing red light on channel key.

### CORRECTIVE ACTION

<p><b>Air In Line</b></p> <p>Air detected in fluid pathway during infusion, or air sensor is dirty.</p>	<ul style="list-style-type: none"><li>• Verify tubing collar is fully seated in air sensor recess.</li><li>• Verify tubing in air sensor recess is not damaged, twisted or dirty.</li><li>• Press <b>ClrAir</b> softkey on channel's Alarm Information page. Three beeps indicate air bubble is no longer in front of air sensor. <i>NOTE: Each press of the ClrAir softkey displaces 0.2 ml of air and fluid and updates channel's VR and VI calculations.</i></li><li>• If air is still present, remove cassette and manually clear air according to hospital policy.</li><li>• If no significant air is present, clean air sensor recess as directed in cleaning instructions.</li><li>• Set up pump at, or slightly below, IV site to minimize formation of micro bubbles.</li><li>• Press  to resume infusion.</li></ul>
<p><b>Air In Lower Tubing</b></p> <p>Air bubbles detected in fluid pathway with a total volume exceeding the air in line threshold setting.</p> <p>Possible outgassing and/or leaks in administration set.</p>	<ul style="list-style-type: none"><li>• Check administration set for leaks.</li><li>• Check lower tubing for multiple small air bubbles.</li><li>• Press <b>ClrAir</b> softkey on channel's Alarm Information page. Three beeps indicate air bubble is no longer in front of air sensor. <i>NOTE: Each press of the ClrAir softkey displaces 0.2 ml of air and fluid and updates channel's VR and VI calculations.</i></li><li>• If air is present, clear air according to hospital policy.</li><li>• Set up pump at or slightly below, IV site to minimize formation of micro bubbles.</li><li>• If no significant air is present, press  to resume infusion.</li></ul>
<p><b>Battery Depleted</b></p> <p>Insufficient battery power. The pump will shut down in 5 minutes.</p>	<ul style="list-style-type: none"><li>• Connect AC adapter power cord to pump and plug into wall outlet.</li><li>• Press  to resume infusion(s).</li></ul>

## ALARMS *(continued)*

Four rapid-beeps audio,  
rapid-flashing red light and  
infusion stops.

### CORRECTIVE ACTION

#### Cassette Jammed

Cassette piston is difficult to move or piston sleeve is loose.

- Remove cassette, check placement of soft, plastic piston sleeve and reposition, if necessary.
- If condition continues, try cassette in a different channel.
- Replace administration set if alarm recurs or if piston does not move freely.
- If Alarm recurs with several cassettes, channel may need service.

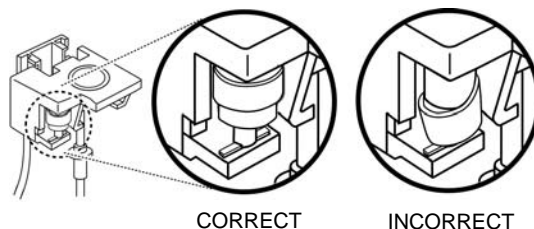

#### Cassette Not Latched

Cassette is partially disengaged or latching mechanism is dirty.

- Push cassette completely in. Ensure slide clamp is flush with entire cassette. Press  to resume infusion.
- If condition continues, try cassette in a different channel. Replace administration set if alarm recurs.
- Clean lower assembly according to Cleaning Instruction described in MAINTENANCE section of this document.

#### Cassette Removed

Cassette is removed from holder while channel is infusing.

- Reinstall cassette, and press  to resume infusion.
- OR
- Press **CANCEL**.

#### Check Fluid Side





Possible upstream restrictions to flow.

- Check tubing between container and pump for a closed regulating clamp, closed vent (with unvented container), kinked tubing, empty syringe, or any restriction to flow.
- If NO occlusion is present, press **CONFIRM**.
- Press  to resume infusion.
- Verify fluid is flowing in drip chamber.
- A ✓ appears on standard display to indicate Confirm has been pressed.

**ALARMS** (continued)

Four rapid-beeps audio, rapid-flashing red light and infusion stops.

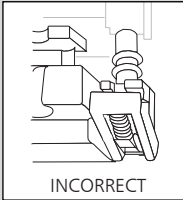
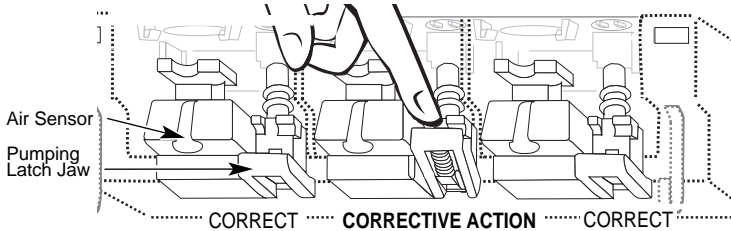
**CORRECTIVE ACTION**

<p><b>Faulty Cassette</b></p> <p>Cassette may be damaged or inoperable. Possible disfunction of cassette sensor located in holder.</p>	<ul style="list-style-type: none"> <li>• Reinsert cassette in another channel.</li> <li>• If alarm recurs in second channel, replace administration set.</li> <li>• If alarm recurs with two cassettes in the same channel, press <b>SERVICE</b> and contact qualified service personnel.</li> </ul>
<p><b>Fluid-Side Occluded</b></p> <p>Upstream restriction to flow.</p>	<ul style="list-style-type: none"> <li>• Check tubing between container and pump for a closed regulating clamp, closed vent (with unvented container), kinked tubing, empty syringe, or any restriction to flow.</li> <li>• Clear occlusion.</li> <li>• Press  to resume infusion.</li> </ul>
<p><b>Patient-Side Occluded</b></p> <p>Downstream restriction to flow.</p>	<ul style="list-style-type: none"> <li>• Check tubing between pump and patient for kinks, closed clamps, closed stopcocks, clogged filters, site problems, etc.</li> <li>• Clear occlusion or change infusion site.</li> <li>• Press  to resume infusion.</li> </ul>
<p><b>Pumping Latch Closed</b></p> <p>Pumping latch jaw located to right of air sensor is closed or broken.</p>  <p>INCORRECT</p> <p>INCORRECT</p>	<ul style="list-style-type: none"> <li>• Using only your finger, push down pumping latch jaw until it snaps open.</li> <li>• If pumping latch jaw is visibly broken, press <b>SERVICE</b> and contact qualified service personnel.</li> </ul> <p><b>CAUTION:</b> Never use a blunt instrument to open a closed pumping latch.</p>  <p>Air Sensor</p> <p>Pumping Latch Jaw</p> <p>CORRECT    CORRECTIVE ACTION    CORRECT</p>
<p><b>Rate/Vol Settings Cleared</b></p> <p>Rates and/or volumes are incompatible with newly selected Device Type.</p>	<ul style="list-style-type: none"> <li>• Re-enter settings as required.</li> <li>• Press  to resume infusion.</li> </ul>

TROUBLESHOOTING

## Fault

Numeric message, European-siren, rapid-flashing red light, infusion stops.

### CORRECTIVE ACTION



#### Channel Out of Order

Safety checks built into software have detected a faulty channel.

#### Fault Number

Safety checks built into software have detected a fault condition.

*CORRECTIVE ACTION for resumable faults, only.*

- Press affected channel , , or .
- Follow instructions on channel's Alarm Information page.
- Press **RETRY** to clear Fault.
- If Fault recurs, press **SERVICE** and contact qualified service personnel.

## Watchdog

Blank screen, continuous-tone red and green lights continuous, all infusions stop.

### CORRECTIVE ACTION

#### Blank Screen

Safety checks built into software have detected an instrument error condition.

Attempt to reset pump:

- Turn pump off, then on again.
- Press  to resume each channel that had been infusing.
- If Watchdog alarm recurs or pump cannot be turned on, replace pump and notify qualified service personnel.

## Other Conditions

### CORRECTIVE ACTION

Screen is too light or dark to read, with pump on.

- Press .
- Press **Cntrst** softkey to change screen contrast.

Pump Shut Off: Low Power Pump had shut down after a Battery Depleted alarm had not been corrected.

- If power cord has been detached from pump, reconnect terminal end to pump's EXTERNAL POWER receptacle.
- Plug AC adapter power cord into electrical outlet.
-  next to EXTERNAL POWER receptacle is lit green when power cord is properly attached.

**Specifications**

<b>STANDARDS</b>	UL 544 CSA C22.2, No. 125
<b>CASE MATERIAL</b>	Impact resistant polycarbonate/ABS alloy
<b>DIMENSIONS</b>	Height 7.875 inches (20.00 centimeters) Width 6 inches (15.24 centimeters) Depth 2.10 inches (5.33 centimeters)
<b>WEIGHT</b>	Approximately 5.1 pounds (2.32 kilograms) includes Pole Clamp.
<b>AIR-IN-LINE (DEFAULT)</b>	500 µl except for Neonatal which is 50µl
<b>OCCLUSION PRESSURE (DEFAULT)</b>	15 psi except for Controller pressure device which is 3 ft H <sub>2</sub> O
<b>OPERATING TEMPERATURE</b>	50-104° Fahrenheit (10° - 40° Celsius)
<b>STORAGE TEMPERATURE</b>	<95° Fahrenheit (<35° Celsius) for optimum battery life.
<b>MAXIMUM STORAGE TEMPERATURE</b>	131° Fahrenheit (55° Celsius)
<b>RATE RANGE</b>	0.1 - 999 milliliter per hour (each channel)
<b>VOLUME RANGE</b>	0.1 - 9999 milliliter (each channel)
<b>KVO RATE RANGE</b>	0.1 - 20.0 milliliter per hour
<b>SYSTEM ACCURACY</b>	1.0 - 999 ml/hr ±5% with a standard deviation of 1.96 under specified conditions. *
<b>* NOTE:</b> Long-term accuracy specified, per IEC 60601-2-24, under the following conditions: Head Height: 30"; Test Solution: Distilled Water; Environmental: Ambient temperature; Back Pressure: 18 gauge needle; IV Set: Model 28034.	0.1 - 0.9 ml/hr ±10% with a standard deviation of 1.96.
<b>ADMINISTRATION SETS</b>	Use only IVAC MedSystem III Administration Sets.
<b>POWER CONSUMPTION</b>	6 watts AC power. Use only IVAC MedSystem III AC Adapter, Model 1555 or 1550.
<b>BATTERIES</b>	Main – Rechargeable NiCd Battery Pack Memory Back-up – Nonrechargeable Lithium
<b>* NOTE:</b> Use only approved ALARIS Medical Systems Battery Packs.	
<b>BATTERY CHARGE</b>	A fully charged battery has a minimum of 6 hours running time with all channels running at 125 milliliter per hour and backlighting usage of 2 minutes per hour. The main battery retains 80% of its capacity after 500 charging cycles, and retains 90% of its capacity after 3 months of continuous AC charging.
<b>* NOTE:</b> Replacement of both the main and memory backup batteries <b>must</b> be performed by qualified service technicians.	
<b>AC ADAPTER &amp; CORD LENGTH</b>	Model 1555, 7.5 VDC @ 1A with 10ft. (3.05 meter) cord. Model 1550, 8.5 VDC @ 750mA with 8.5ft. (2.59 meter) cord.
<b>AC ADAPTER CONNECTOR</b>	4 pin locking connector is standard on Model 2863. Detachable connector is standard on Model 2860.
<b>FUSES</b>	3 amp fast-blow internal
<b>GROUND CONTINUITY</b>	Maximum 0.1 ohm
<b>LEAKAGE CURRENT</b>	Maximum 100 microamps

## Cleaning

Clean the pump regularly to maintain proper working order and optimum performance.

**WARNING:** *To avoid electrical hazard, always disconnect AC adapter power cord from the wall outlet before cleaning the instrument.*

### CAUTIONS:

- **DO NOT SPRAY** cleaning solutions onto instrument housing or immerse the instrument. Fluid leakage into the instrument can cause damage. Apply cleaning solutions to a cloth then apply to instrument for cleaning.
- Do not clean the instrument before inspecting the condition of the housing for damage that could allow fluid to enter the case interior.
- Do not invert the instrument when cleaning or rinsing, to prevent fluids from possibly leaking into the instrument.
- Do not steam, autoclave, or EtO gas sterilize the instrument.
- Do not use pressurized air to dry the mechanisms after cleaning. Pressurized air force could move fluid past moisture seals and fluid leakage into the instrument can cause damage.
- Do not use organic solvents, ammonia, ammonium-based agents, isopropyl alcohol, and/or abrasive cleansers for cleaning.
- Do not use sharp or metallic tools to remove residue.

## Before Cleaning

Instrument exterior and pumping mechanism area, use:

- Mild, non-abrasive, non-staining solution (e.g., commercially available, alcohol-free, dish washing liquid, well diluted with warm water.)

Instrument exterior, use:

- Mild, non-abrasive, non-staining, standard hospital disinfectant (e.g., warm water with 10% bleach.)

**NOTE:** *After cleaning with a bleach solution, rinse thoroughly with water.*

Instrument Exterior

- Routinely clean the exterior surfaces of the instrument, using a cloth dampened with the appropriate cleaning



## To Clean

solution, as specified in the “Cleaning Solutions” section.

- Rinse with a cloth dampened with water.
- Wipe dry with a clean cloth or allow to air dry.

### Lower Housing Removal to Access Pumping Mechanisms

- To access the pumping mechanisms, remove the lower housing by simultaneously depressing the four black release tabs and pulling straight down.

### Slide Link and Pumping Mechanism

- Place the instrument in the upright position.
- Clean the slide link and pump latch mechanism using small soft-bristled brush (or lint-free swab), dampened with the appropriate cleaning solution, as specified in the “Cleaning Solutions” section. If dried residue is difficult to remove, or the slide link or pump latch sticks, spray the cleaning solution on the residue and allow it to soak until it can be more easily removed.
- After removing residue, rinse with a lint-free swab dampened with water. Water may be sprayed on the cleaned surfaces to rinse areas that are difficult to reach with a swab.
- Dry with a lint-free swab or cloth, or allow to air dry.

### Air-in-line Sensor

**NOTE:** Air-in-line alarms may occur when dried residue builds up in the air-in-line sensor tubing recess.

- Inspect the air-in-line sensor module to ensure that there is no separation or breakage of the glued seams.

**NOTE:** Defective air-in-line sensor modules must be replaced before using the instrument.

- Place the instrument in the upright position.
- Clean the tubing recess (using a downward motion) with a lint-free swab dampened with the appropriate cleaning solution, as specified in the “Cleaning Solutions” section.

**CAUTION:** Use of abrasives or abrasive cleaners on the air-in-line sensor recess may cause false Air-in-line or Check Air Sensor alarms.

- Rinse with a lint-free swab dampened with water.
- Dry with a lint-free swab or allow to air dry.

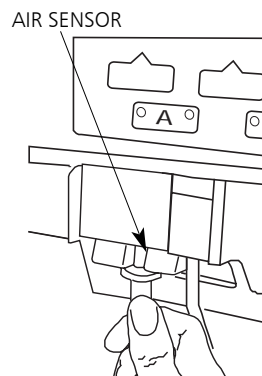
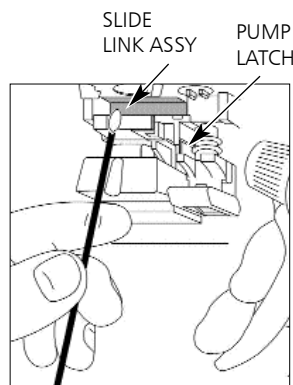
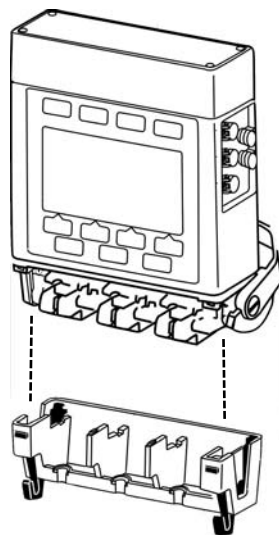

## Optomodule

**WARNING:** When cleaning the optomodule, use **EXTREME CARE** to avoid damage to valve actuators. Damage or breakage of the actuator tips could cause an uncontrolled flow condition.

**CAUTION:** Do not use isopropyl alcohol or chlorine water on the optomodule.

- Place the instrument in the upright position.
- Gently clean the optomodule using a lint-free swab dampened with the appropriate cleaning solution, as specified in the "Cleaning Solutions" section. The cleaning solution may be sprayed on difficult to remove residue to help wet and soften the residue for easier removal.
- After removing residue, gently rinse with a lint-free swab dampened with water. Water may be sprayed on the cleaned surfaces to rinse areas that are difficult to reach with a swab.
- Gently dry with a lint-free swab or allow to air dry.

## Valve Actuator

**WARNING:** Care must be taken when cleaning the vicinity of the valve actuators to avoid damage and breakage of the actuator tips. Damage or breakage of the actuator tips could cause an uncontrolled flow condition.

**CAUTION:** Do not use isopropyl alcohol to clean the valve actuators.

- Gently clean the valve actuator and actuator seal area using a lint-free swab dampened with the appropriate cleaning solution, as specified in the "Cleaning Solutions" section. The cleaning solution may be sprayed on difficult to remove residue to help wet and soften the residue for easier removal.
- After removing the residue, gently rinse using a lint-free swab dampened with water. Water may be sprayed on the cleaned surfaces to rinse areas that are difficult to reach with a swab.
- Gently dry with a lint-free swab or allow to air dry.
- After cleaning, inspect the exposed tips of the valve actuators. A broken tip may be supported by the actuator seal and not appear defective. Lightly attempt to push the tips of the valve actuators from side to side with a dry lint-free swab. If a tip is not rigid, then it is broken and must be replaced before using the instrument.

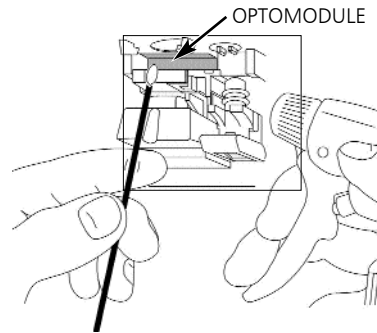

**NOTE:** Use extra-diluted, non-alcohol cleaning solution.

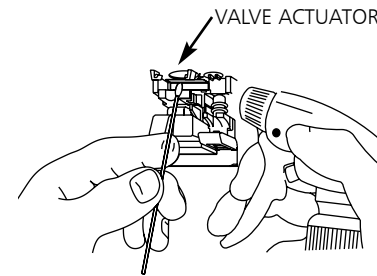

**NOTE:** A broken valve actuator tip may be supported by the actuator seal and may not appear defective.

**WARNING:** Damage to the valve actuators can cause an uncontrolled flow condition. Do not clean with sharp or hard tools. Only clean with a non-abrasive, lint-free swab.

## Inspection Requirements

To ensure the pump remains in good operating condition, both regular and periodic inspections are required. Any instrument that does not meet listed specifications should be serviced.

**WARNING:** *Failure to perform these inspections may result in improper instrument operation.*

Regular inspections consist of performing the procedures described in the Basic Operation and Cleaning sections of this manual before use of the pump. Regular inspections are not covered under any contract or agreement offered by Alaris Medical Systems, and must be performed by the user.

When programming infusions verify the display:

- Is complete and not blurred;
- Reads the same as described in this manual;
- Responds with the intended function for that key press.

Periodic inspections must be performed every 12 months. A service agreement may be obtained from Alaris Medical Systems, for the performance of all required periodic inspections.

The periodic inspections must be performed in accordance with Alaris Medical Systems requirements and guidelines. Customers within the United States and Canada should note that these inspections are also intended to complement the intent of Joint Commission on the Accreditation of Healthcare Organizations requirements.

**NOTE:** *Detailed instructions for performing periodic inspections and maintenance can be found in the Technical Service Manual for the IVAC MedSystem III Multi-Channel Infusion Pump and in supplemental service bulletins.*

## Service Information

If the instrument fails to respond as described in this manual and the cause cannot be determined, do not use the instrument. Contact qualified service personnel.

Within the United States, application and service information may be obtained by writing to the ALARIS Medical Systems Customer Service Department at:

ALARIS Medical Systems  
ATTN: Customer Service  
10221 Wateridge Circle  
San Diego, California 92121

Within the United States and Canada, a toll-free telephone number has been set up for your convenience.

*For information or assistance, or to arrange for the return of an instrument for repair, call:*

In the United States - **(800) 854-7128**  
In Canada - **(905) 507-1131**

*For clinical or technical support, call:*

**(800) 854-7128**

Outside the United States and Canada, service information, applications, and manuals may be obtained by contacting your local ALARIS Medical Systems Service Department or distribution center.

When submitting a request for service, include:

- a description of the difficulty experienced
- instrument settings
- administration set model and lot number
- solution used
- message displayed at the time of difficulty

If it is necessary to return the instrument for service, obtain a return authorization prior to shipment. Carefully package the instrument (preferably in the original packaging), reference the return authorization information, and return it to the appropriate service or distribution center. ALARIS Medical Systems cannot assume any responsibility for loss of or damage to instruments while in transit to ALARIS Medical Systems.

---

---

# WARRANTY

---

---

ALARIS Medical Systems Inc., (hereinafter referred to as ALARIS Medical Systems) warrants that:

- A. Each new ALARIS Medical Systems instrument (excluding the battery) is free from defects in material and workmanship under normal use and service for a period of one (1) year from the date of delivery by ALARIS Medical Systems to the original purchaser.
- B. The battery and each new accessory are free from defects in material and workmanship under normal use and service for a period of ninety (90) days from the date of delivery by ALARIS Medical Systems to the original purchaser.

If any product requires service during the applicable warranty period, the purchaser should communicate directly with ALARIS Medical Systems headquarters (San Diego, CA) to determine the appropriate repair facility. Except as provided otherwise in this warranty, repair or replacement will be carried out at ALARIS Medical Systems' expense. The product requiring service should be returned promptly, properly packaged and postage prepaid by purchaser. Loss or damage in return shipment to the repair facility shall be at purchaser's risk.

In no event shall ALARIS Medical Systems be liable for any incidental, indirect or consequential damages in connection with the purchase or use of any ALARIS Medical Systems product. This warranty shall apply solely to the original purchaser. This warranty shall not apply to any subsequent owner or holder of the product. Furthermore, this warranty shall not apply to, and ALARIS Medical Systems shall not be responsible for, any loss or damage arising in connection with the purchase or use of any ALARIS Medical Systems product which has been:

- (a) repaired by anyone other than an authorized ALARIS Medical Systems service representative;
  - (b) altered in any way so as to affect, in ALARIS Medical Systems judgment, the product's stability or reliability;
  - (c) subjected to misuse, or negligence, or accident, or which has had the product's serial or lot number altered, effaced or removed;
- or
- (d) improperly maintained or used in any manner other than in accordance with the written instructions furnished by ALARIS Medical Systems.

This warranty is in lieu of all other warranties, express or implied, and of all other obligations or liabilities of ALARIS Medical Systems, and ALARIS Medical Systems does not give or grant, directly or indirectly, the authority to any representative or other person to assume on behalf of ALARIS Medical Systems any other liability in connection with the sale or use of ALARIS Medical Systems products.

ALARIS MEDICAL SYSTEMS DISCLAIMS ALL OTHER WARRANTIES, EXPRESS OR IMPLIED, INCLUDING ANY WARRANTY OF MERCHANTABILITY OR OF FITNESS FOR A PARTICULAR PURPOSE OR APPLICATION.

See packing inserts for international warranty, if applicable.

---

---

### Abbreviations, Acronyms, Units of Measure

1° Pri	Primary infusion
2° Sec	Secondary infusion
a	am
AAMI	American Association of Medical Instrumentation
ABS	acrylonitrile-butadiene-styrene
AC	alternating current (electrical power)
ANSI	American National Standards Institute
BatLog	Battery History Log
Calc	Calculator
CalcOff	Dose Rate Calculator Off
CalcOn	Dose Rate Calculator On
ClrAir	Clear Air
Cntrst	Contrast
COMM	Communications Port
Conc	Concentration
Config	Configuration
CP	Controller Pressure
CSA	Canadian Standards Association
DemoWD	Demonstrate Watchdog
DI	Dose Infused
ECRI	Emergency Care Research Institute (ECRI, Plymouth Meeting, PA)
ECG	Electro-cardiogram
ES	Electro-static
FMS	Field Maintenance Software
Gm	gram
GP	General Purpose
GP II	General Purpose II
h	hour
in.	inch
I.D.	identification
IEC	International Electrical Code
Inf	infused
IV	intravenous
JCAHO	Joint Commission on the Accreditation of Health Care Organizations
K	1,000 for numbers 10,000 or greater
KG; kg	kilogram
KVO	keep vein open
LB; lb	pound
mcg	microgram
mEq	milliequivalent
mg	milligram
min; mn	minute

ml	milliliter
mMol	millimole
mUn	milliUnit
μl	microliter
N/A	not applicable
Neontl	Neonatal
NextPg	Next Page
ng	Nanogram
NiCd	nickel-cadmium
OR	Operating Room
OR II	Operating Room II
p	pm
Pri	Primary
psi	pounds per square inch
Sec	Secondary
Stnd Disp	Standard Display
STNDBY	Standby
TotVol	Total Volume
TR	time remaining
UL	Underwriters Laboratories, Inc.
Un	unit
VI	volume infused
Vol	volume
VolRem	volume remaining
VR	volume remaining
Wt	weight

## Symbols



Refer to accompany documents for complete instructions.



Canadian Standards Association



Underwriters Laboratories



Plug



Direct Current



Flammable Anesthetics  
DANGER: Explosion risk if used with flammable anesthetics.



CITECH certification mark

**CITECH**

THERE IS  
NO  
PRINTING  
ON THIS  
PAGE

---





Corporate Office:  
10221 Wateridge Circle  
San Diego, California 92121-2733  
Mail: P.O. Box 85335  
San Diego, California 92186-5335



To Purchase, Visit [Avobus.com](http://Avobus.com) or call [1-800-674-3655](tel:1-800-674-3655)